



Electristove VR Stratford Electric Stove

Electristove VR Stratford - B-1032387 - EFVRSTRE

Packing Checklist - Pack 1 of 2

Electric Stove
Remote Control Handset* with wall mounting bracket
Ember Ice Set
Instruction Manual

Packing Checklist - Pack 2 of 2

Ceramic Log Set

***THIS PRODUCT REQUIRES 3 X AAA BATTERIES FOR USE IN THE HANDSET (NOT SUPPLIED)**

IMPORTANT

**PLEASE READ THESE INSTRUCTIONS CAREFULLY BEFORE
INSTALLATION AND USE OF THIS ELECTRIC STOVE AND
RETAIN FOR FUTURE REFERENCE.**

Children of less than 3 years should be kept away unless continuously supervised.

Children aged from 3 years and less than 8 years shall only switch on/off the stove provided that it has been placed or installed in its intended normal operating position and they have been given supervision or instruction concerning use of the stove in a safe way and understand the hazards involved. Children aged from 3 years and less than 8 years shall not plug in, regulate and clean the stove or perform user maintenance.

This stove is not intended for use by persons (including children) with reduced physical, sensory or learning disabilities, or lack of experience and knowledge, unless given supervision or instruction concerning use of.

If the supply cord is damaged, it must be replaced by the manufacturer, its service agent or similarly qualified persons in order to avoid a hazard.

IMPORTANT SAFETY ADVICE

WHEN USING AN ELECTRICAL STOVE, BASIC PRECAUTIONS SHOULD ALWAYS BE FOLLOWED TO REDUCE THE RISK OF STOVE, ELECTRIC SHOCK AND INJURY TO PERSONS, INCLUDING THE FOLLOWING IMPORTANT SAFETY ADVICE.

DO NOT cover the heater, to avoid overheating of the product.



DO NOT leave the heater unattended while it is in use. Always turn the stove to the OFF position and switch off at the mains socket when not in use.

DO NOT leave children unsupervised whilst the stove is switched on.

DO NOT operate this stove with a damaged cord or plug, or after the stove malfunctions, has been dropped or damaged in any way. Contact the manufacturer.

DO NOT install a timer switch to operate the stove.

DO NOT insert or allow objects to enter any ventilation or exhaust openings on the stove. To prevent a possible stove do not block air intakes or exhaust openings in any manner.

DO NOT place this stove near flammable materials, surfaces or substances, as there may be a risk of fire. Keep flammable materials, surfaces or substances at least 1 metre away from the front of the product.

DO NOT switch on the stove if volatile vapours are present in the room.

DO NOT use this stove in any areas where petrol, paint or other flammable liquids are stored e.g. a garage or a workshop as the stove contains components capable of producing a spark.

DO NOT touch any hot surfaces such as the heater vent when the heater is in use to avoid burns and personal injury.

DO NOT install the heater immediately below an electrical socket outlet.

DO NOT use outdoors.

CAUTION - Some parts of this product can become hot during use and cause burns. Particular attention has to be given where children and vulnerable people are present.

This stove is for household use only

PRODUCT TECHNICAL DATA SHEET

Supplier Name / Trademark

Celsi

Supplier Model Identifier

B-1032387
Electristove VR Stratford

Voltage

230v AC 50HZ

Fuse

13 Amp

Nominal Heat Output (Measured)

2.0kW

Minimum Heat Output (Indicative)

1.0kW

Maximum Continuous Heat Output

2.0kW

Auxilliary Electrical Consumption at Nominal Heat Output

32W

Auxilliary Electrical Consumption at Minimum Heat Output

32W

Auxilliary Electrical Consumption at Standby Mode

1.5W

Type of Heat Output / RTC*

With electronic room temperature control plus 7 day timer.

Other Control Options

With adaptive start control

Manufacturers Name and Address

BFM Europe Ltd. Gordon Banks Drive,
Trentham Lakes, Stoke-on-Trent,
Staffordshire, ST4 4TJ
Tel: 01782 339000

*RTC = Room Temperature Control

Stove Dimensions - Fig. 1

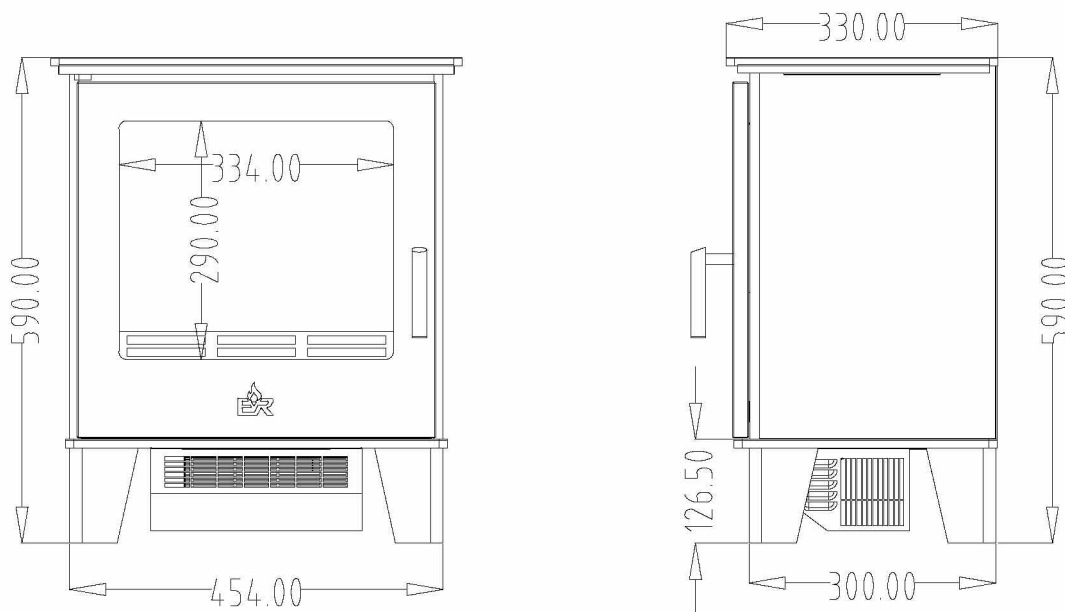

Unpacking

Remove and discard the plastic bag.

Be responsible when handling the packing materials.

Keep the original packaging for future transportation and/or storage.

Check all accessories are removed from the packaging before storing it away for future use.

KEEP PLASTIC BAGS AWAY FROM CHILDREN!

Choosing a Suitable Location

The stove must have a minimum clearance of 15mm to combustible material on all sides.

A clearance of minimum 15mm to non-combustible materials is also required to ensure correct operation.

This stove is for indoor installation only and is not designed to be installed outside. The stove must be kept away from any source of damp or moist conditions. Avoid any close contact with water. **Stove must be installed on a non-combustible hearth.**

If there is any doubt regarding the suitability of the installation site please contact your retailer.

The stove can be connected directly to a fused spur or plugged into a mains socket.

Ensure that the plug socket-outlet connection for this stove is accessible. It MUST be readily accessible for easy electrical isolation in the event of servicing and replacing components etc.

This stove **MUST NOT** be located immediately below an electrical socket-outlet.

Installation

Installation must be carried out by a qualified and competent person.

Connect the stove to single-phase AC supply of the voltage specified on the rating plate.

Should the stove be connected directly into the mains supply, then a fused switched spur with a 13 amp fuse must be fitted.

It is imperative that the power supply is capable of handling the electrical load as stated on page 2 of this manual.

This stove must be earthed.

Do not use an extension lead.

Always ensure that all electrical work complies with the relevant Building Regulations and the Electrical Code of Practice. All electrical work should be carried out by a qualified electrician.

ENSURE THAT THE HEATER ELEMENT OUTLET IS NOT OBSTRUCTED AND COMBUSTIBLE MATERIAL IS NOT PLACED IN FRONT OF IT.

Fitting the Logs

Take care when unpacking the Logs and the Ember Ice crystals supplied with your stove.

Open the door on the stove then remove the top panel via the four screws as indicated, the image shows the stove top panel removed to display the position of the screws. Remove the Top LED strip retaining screws to allow better access. To do this unscrew the fixing screws as indicated below in figure 2.

Fig. 2

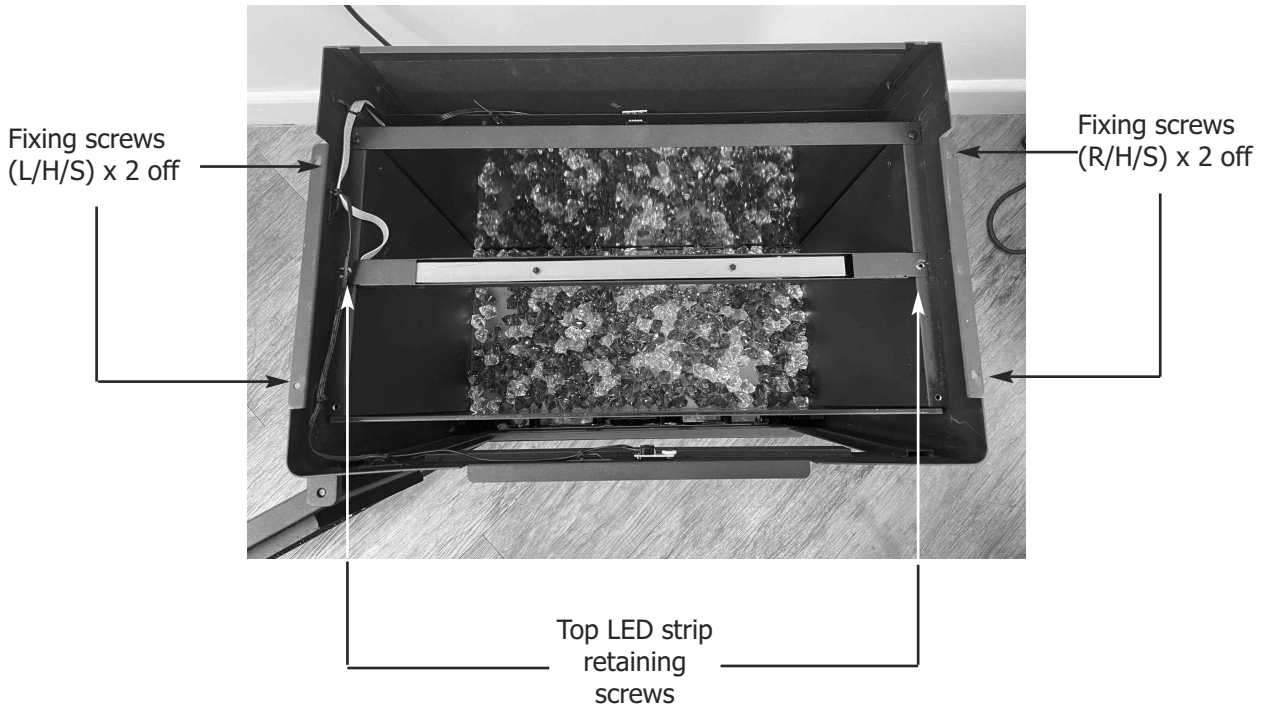

Position the logs as shown below in figure 3, to obtain the same layout.

Fig. 3



Scatter the Ember Ice over the fire bed making sure the black and clear embers are mixed evenly.

Operating the Stove

This stove can be operated using 4 methods:

Manual Control using the controls on the stove

Remote Control using the included remote-control handset

Celsi App Control using smartphone or tablet voice control, Alexa or Google Assistant

Manual Control

This stove can be operated manually using the control panel as shown below in figure 4.

Fig. 4

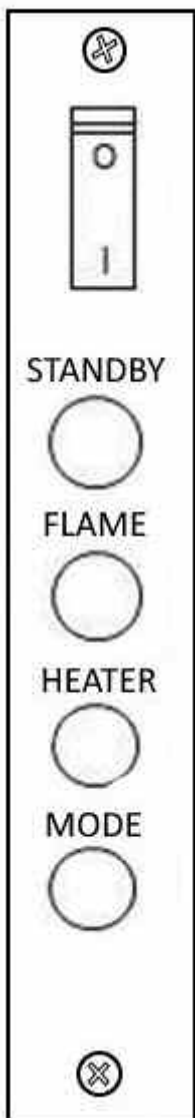

ON / OFF Power Switch

This switch is used to turn the mains supply to the stove ON or OFF. When the switch is in the ON position an indicator light located in the centre of the screen will glow amber to indicate the stove is switched on and in standby mode. This needs to be in the ON position for both manual and remote operation.

STANDBY

Used to switch stove ON or OFF into standby mode.

FLAME

Pressing this button will cycle through the 4 different flame brightness levels.

HEATER

Use this button to select Low Heat, High Heat or heater OFF.

When LOW heat is selected the indicator light will glow amber for 5 seconds. When HIGH heat is selected the indicator light will glow red for 5 seconds.

Please note the heater will only operate when the room temperature is below the temperature set on the handset, which can be adjusted using the remote control or app. When the heater switches off, the fan will still continue to run for a short period to allow the stove to cool down.

MODE

Use this button to cycle through and select 1 of the 16 preset LED colour combinations. Press and hold until a confirmation beep is heard to set on 'Colour Animation' mode to slowly cycle through all the colour combinations.

Remote Control

Remove the battery cover on the rear and insert 3 x AAA batteries ensuring the batteries are fitted correctly. Refit the cover. Please ensure old batteries are disposed of responsibly by contacting your local authority about recycling schemes.

Ensure that the ON / OFF Power Switch on the stove is in the ON position.

Before the handset as shown below in figure 5 can be used the current day and time will need to be set (see clock setting instructions on the next page).

Fig. 5

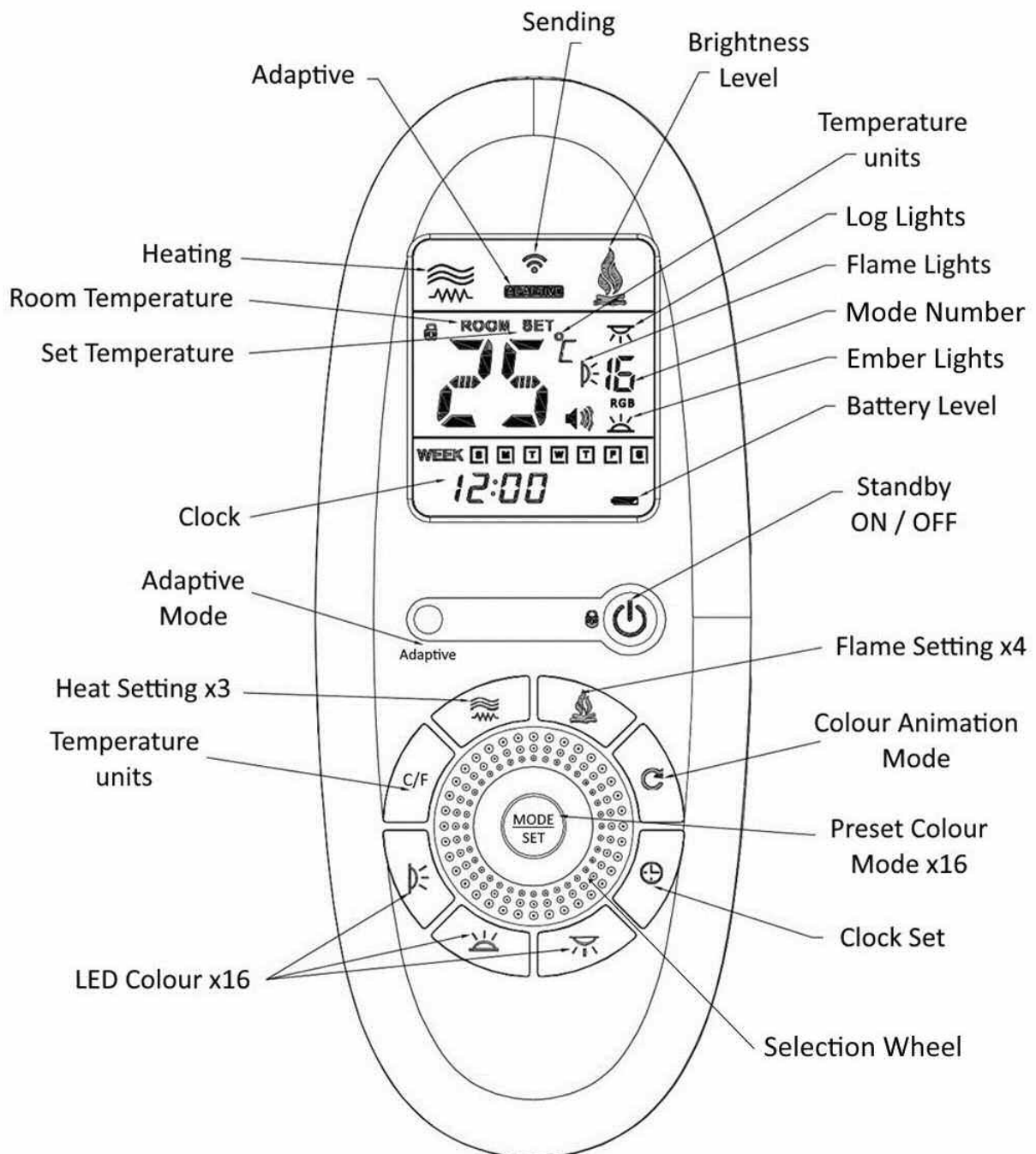

To use the remote handset ensure it is pointed directly towards the stove and press the appropriate button to operate the stove.

Operating the Stove and Child Lock mode



1. Use the On/Off button to switch the stove On and Off.
2. Holding the button in for 5 seconds will enable the Child Lock mode (a padlock will appear on the handset display).
3. To disable the child lock press the On/Off button once.
Note: that after a short period of time the handset will automatically enable the Child Lock mode.

Clock Setting



1. Press the Clock Set button, which will start the day cursor to blink. Using the selection wheel rotate to the current day e.g. S M T W T F S then press the Clock Set button to confirm.
2. The hour will now be blinking, set using the selection wheel and confirm using the Clock Set button.
3. The minute will now be blinking, set using the selection wheel and confirm using the Clock Set button.

Flame Setting



1. Pressing this button will cycle through the 4 brightness settings of the LED flame effects.

Heat Setting



1. Use to change the heater setting from LOW, HIGH and OFF
2. When the heater is ON the actual room temperature is displayed on the handset
3. By using the selection wheel you can set the desired temperature, this will save after 5 seconds and the room temperature will be displayed

Note: the heater will only operate when the room temperature is below the temperature set on the handset. When the heater switches off, the fan will still continue to run for a short period to allow the stove to cool down.



The displayed temperature can be displayed in Celsius or Fahrenheit. To change use the Temperature units button.

LED Colour Settings

1. Press the Mode/Set button and use the selection wheel to select one of the 16 preset LED colour combinations (the preset number will be displayed on the handset)

If preferred, the LED colour settings can be changed individually for the

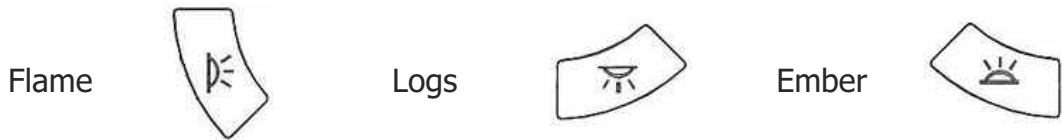

1. Press the one of the buttons above (symbol will flash on display) and use the selection wheel to select your required colour setting for the specific lighting function.

Alternatively the stove can be set to Colour Animation mode



1. Pressing the Colour Animation mode button will set the Lighting to a red glow and then will slowly cycle through the 16 preset colour combinations.
2. Press the Colour Animation mode to exit the animation mode.

Adaptive Mode

Adaptive mode works in conjunction with the timer programmes. When Adaptive mode is turned ON the stove monitors the room temperature in relation to the selected target temperature. If the room temperature is sufficiently lower than the selected temperature the Adaptive mode will instruct the stove to switch on up to 10 minutes earlier than the set time to ensure the room is at the required temperature at the set time.

Celsi App Control

The Celsi app can be downloaded from the IOS App Store or the Google Play Store by either searching for Celsi or by scanning the QR code using a smart phone or tablet.



The Celsi app can be used alongside the remote handset and provides additional feature of 7 day Timer function.

**** During the initial set up of the App, the stove needs to be in pairing mode ****

Pairing Mode

With the stove off and in Standby mode press and hold the Standby button on the stove to hear a beep and continue holding for 5 seconds to observe a red flashing light on the rear screen. When this light is flashing the product is in pairing mode.

App Setup

1. Open the app and when prompted either create a new Celsi account or Login using your existing account details.
2. Once logged in, accept the notification to allow permission for the Celsi app to access Notifications and Bluetooth.
3. On your smart device ensure that Bluetooth and Wi-Fi are switched ON.
4. Ensure the stove is in pairing mode.
5. On the app the All Devices screen will be displayed. Press the + button at the top R/H corner.
6. Allow the app to connect to devices on local network.
7. Click on Add button to discover devices.
8. Click on Manual Input and add the name and password of the Wi-Fi network you are connecting the stove to.
9. Follow the on screen instructions to add device.

Using the App

Fig. 6

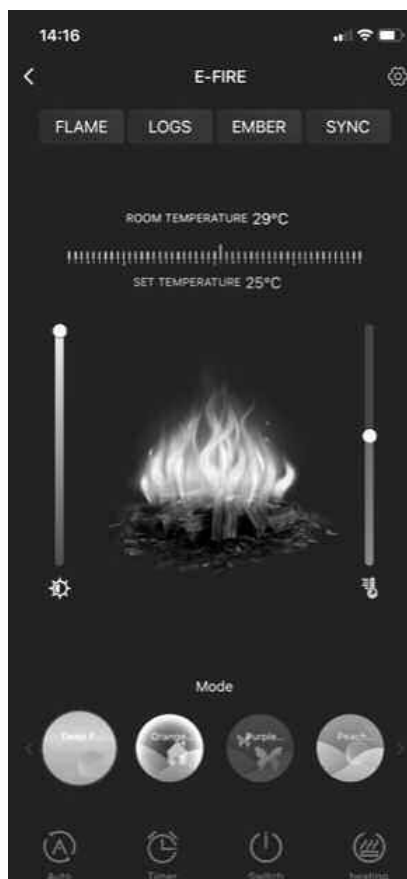

The Home page of the app will allow you to operate and customise the appearance of your stove using the touchscreen interface as shown opposite in figure 6.

The app has all the same features as the remote handset along with an additional 7 day Timer function. Using this function you can set timers for the stove to switch on at a given time day / time.

Further information is available within FAQ section of the app.

Connection to Alexa

Once you have set up your Celsi account and successfully paired your device you can now also connect to Alexa.

Fig. 7

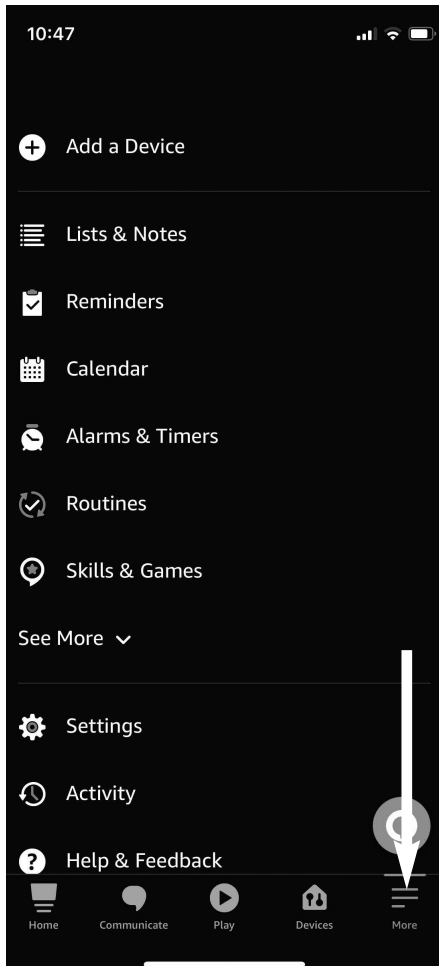
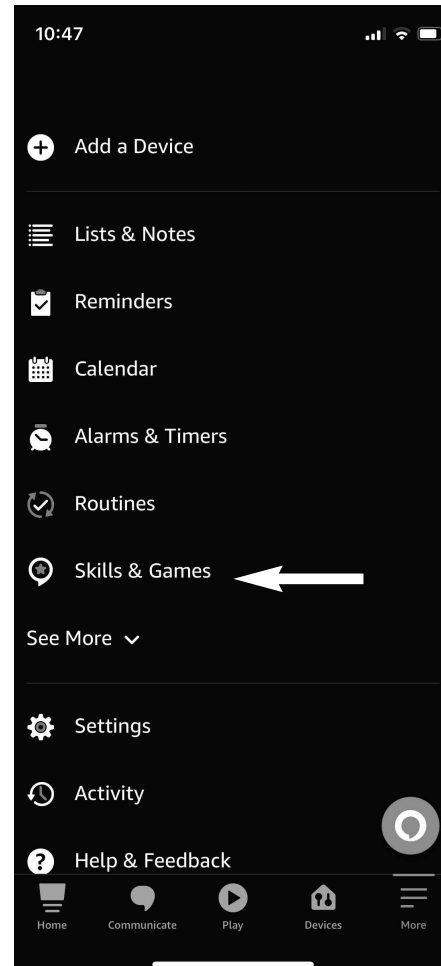

Fig. 8



To connect, open the Alexa App and select the "More" tab in the bottom right hand corner as shown in figure 11 above.

Then select the "skills and games" tab as indicated in figure 12 above.

Then click the "search" icon in the top right hand corner as shown below in figure 9, then search for the "smart life" skill by typing "smart life" into the search box as shown below in figure 10.

Fig. 9

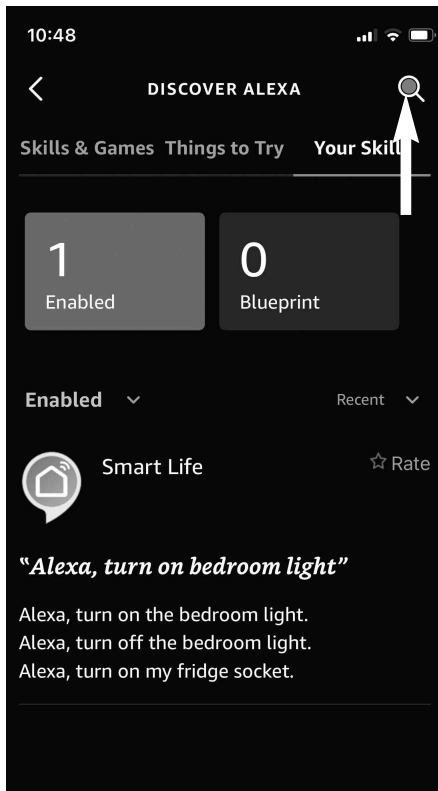
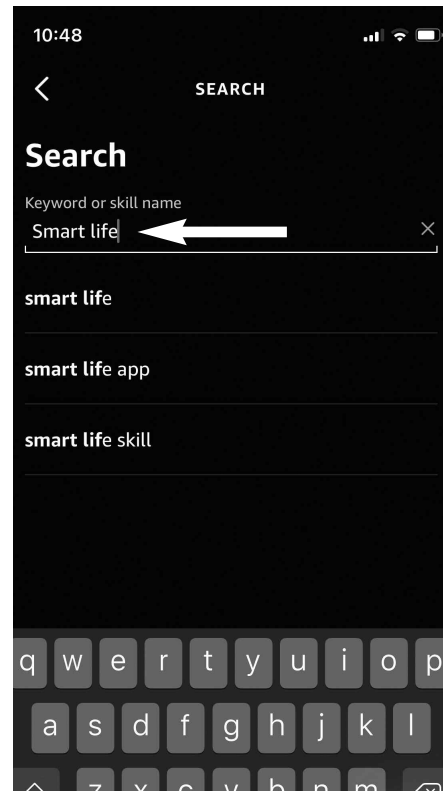

Fig. 10



Install onto your device by clicking the "smart life" icon shown below in figure 11, then the "enable to use" icon as shown in figure 12.

Fig. 11

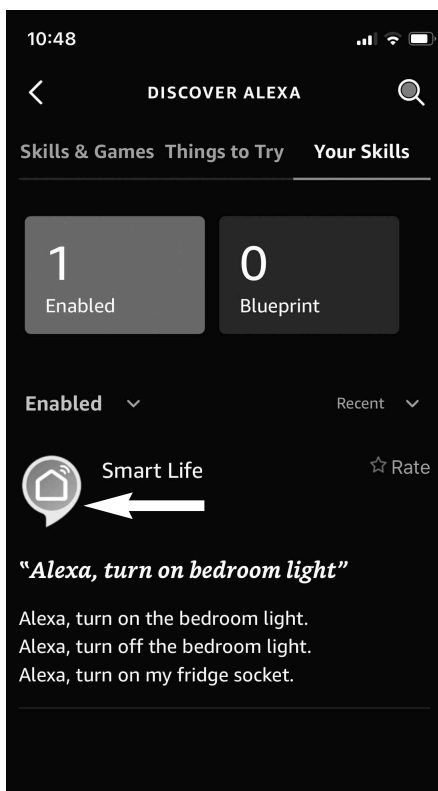
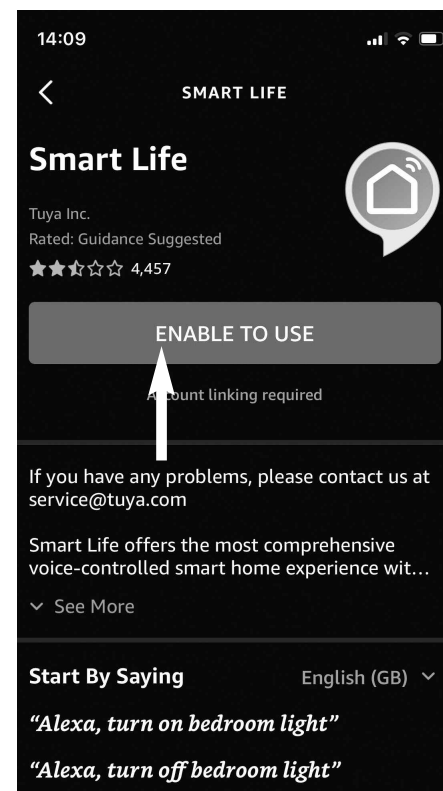

Fig. 12



This will prompt you for your e-mail address and password that you used when registering the Celsi APP as shown below, enter the e-mail address and tick the user agreement box as indicated below in figure 13.

Complete the verification puzzle as prompted, then enter your password and complete a second verification puzzle as requested.

This will then bring up the confirmation page that the account has been successfully linked as shown below in figure 14.

Fig. 13

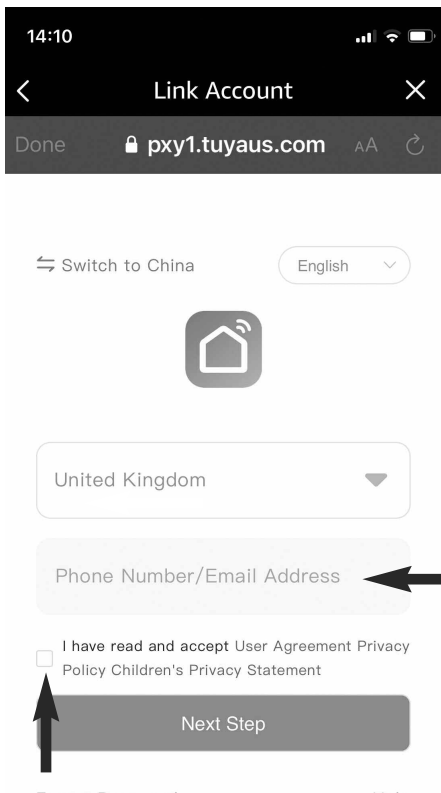
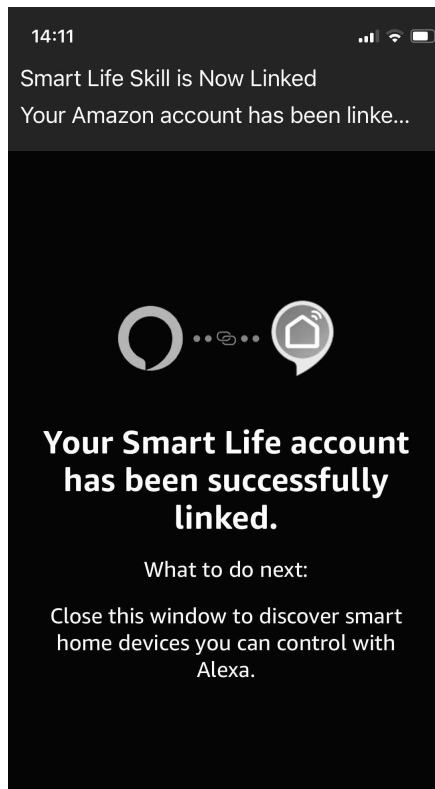

Fig. 14



The product should then operate from voice activation.

i.e. "Alexa, turn fire on", "Alexa, turn fire off".

Connection to Google Assistant

Once you have set up your Celsi account and successfully paired your device you can now also connect to Google Assistant.

Fig. 15

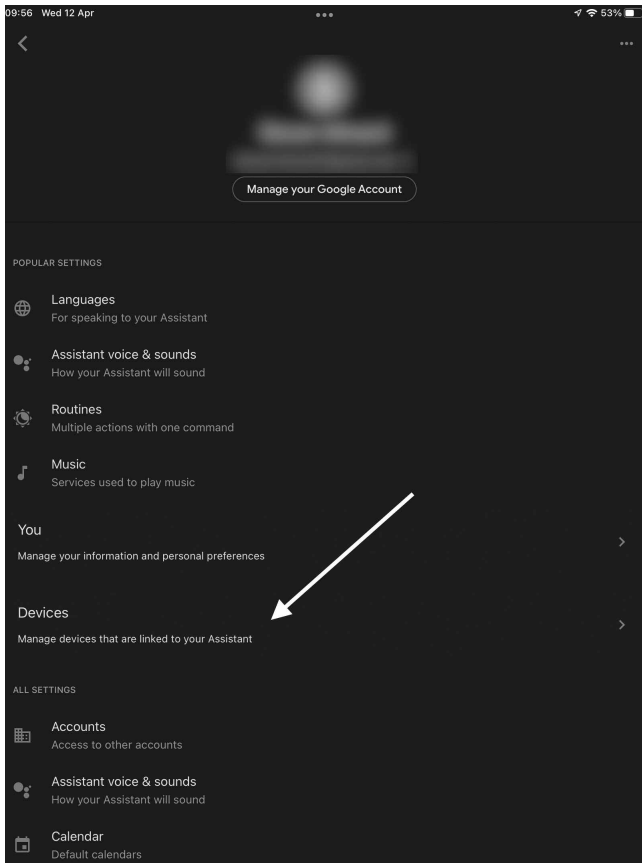
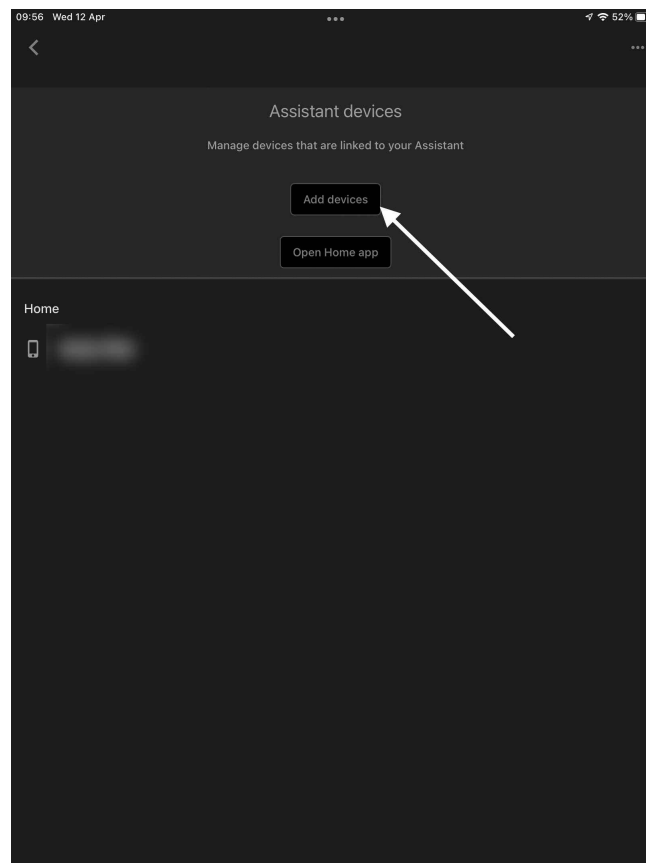

Fig. 16



To connect, open the Google Assistant App and select the "Device" tab on the left hand side as shown above in figure 15, then click the "add devices" tab when prompted as shown above on the right in figure 16.

Then select the "link a smart home device" tab as indicated overpage in figure 17

Select the "link a smart home device" tab as indicated below in figure 17.

Fig. 17

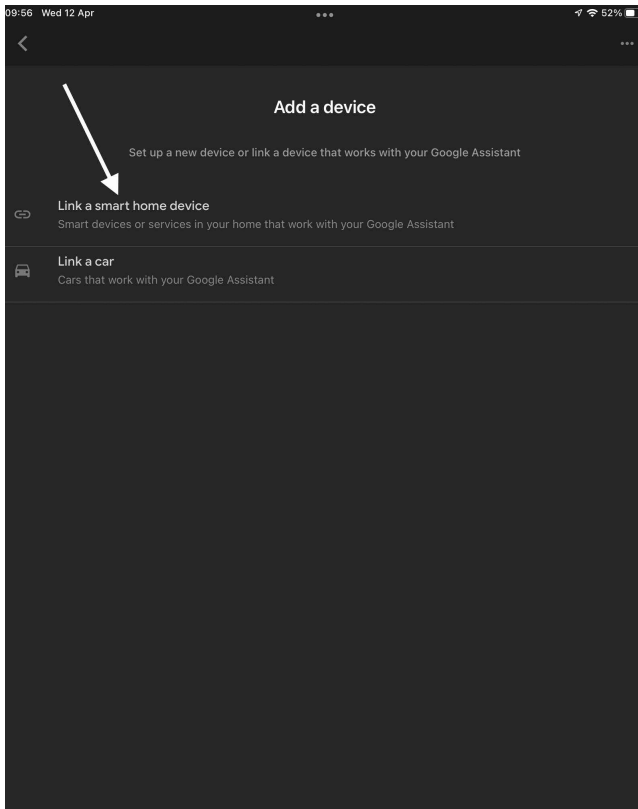
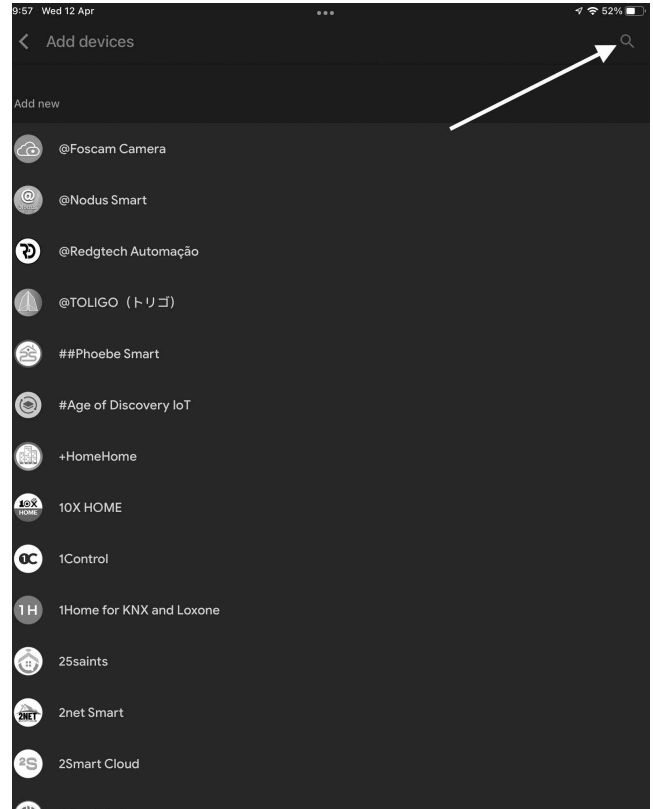

Fig. 18



Click the "search" icon in the top right hand corner as shown figure 17 above, then enter "smart life" as the searched for as shown in figure 19. Select the "smart life icon as shown in figure 20 below.

Fig. 19

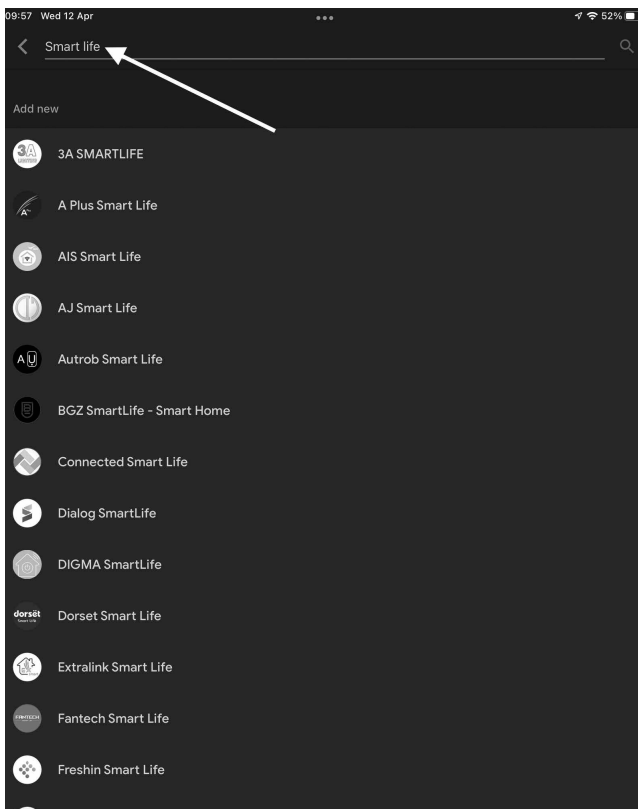
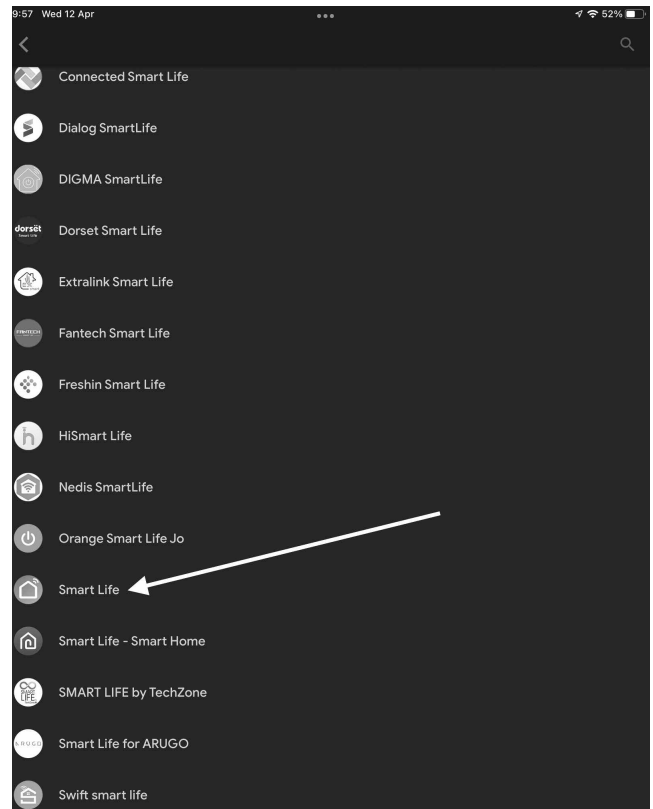
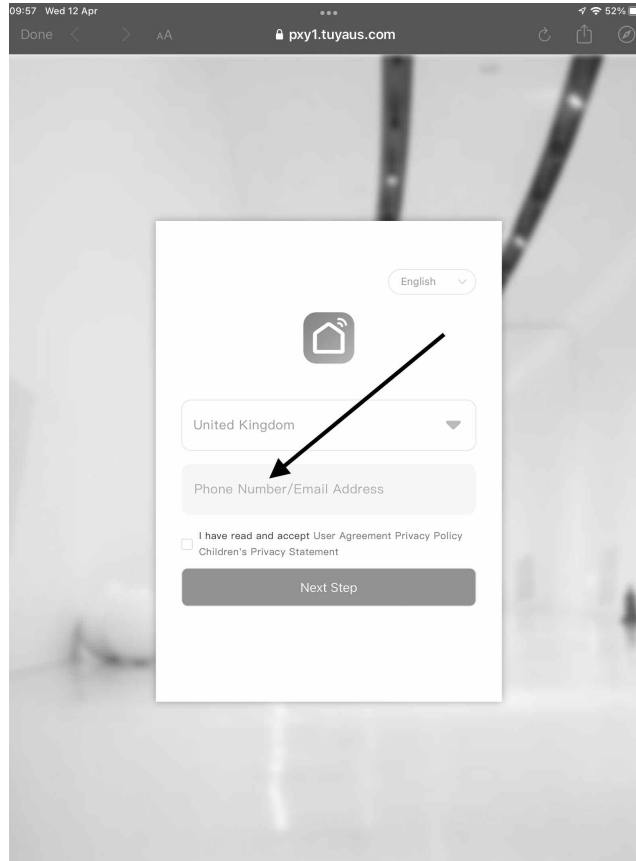

Fig. 20



This will prompt you for your e-mail address and password that you used when registering the Celsi APP as shown below, enter the e-mail address and tick the user agreement box as indicated below in figure 21.

Fig. 21



The product should then operate from voice activation, open the google assistant app, click then click the microphone logo at the bottom centre and give instruction i.e. "turn fire on", "turn fire off" as shown in figure 22 below.

Fig. 22

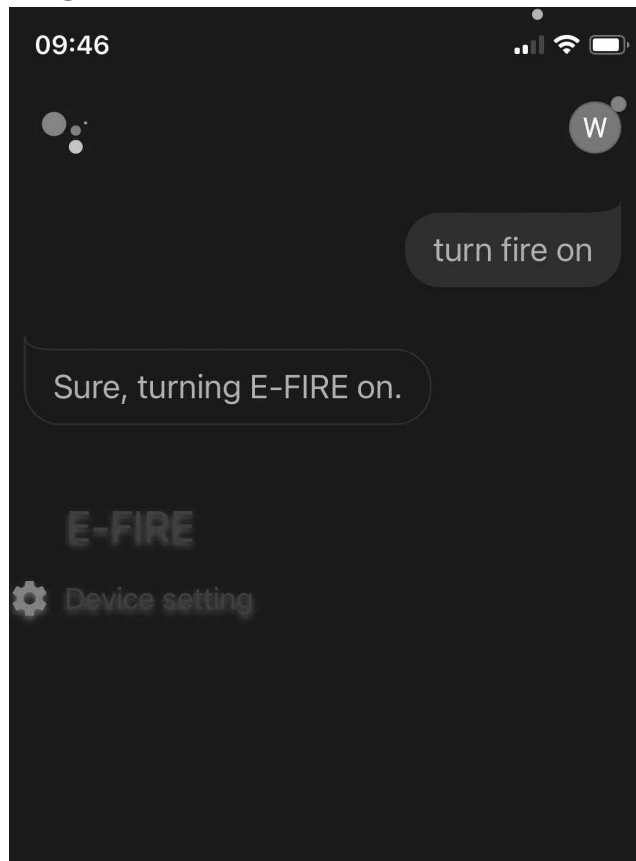

IMPORTANT

This stove is fitted with an automatic thermal cut-out safety feature to reduce the risk of damage to stove due to overheating. If the stove overheats the heater element will cut out whilst the fan will still continue to run to allow the fire to cool down sufficiently.

Once the stove has cooled down the thermal cut-out will reset itself and switch the heater back on. If the problem persists switch the stove off and disconnect the power at the switch and plug socket. Check that the heater warm air outlets and the inlets are not obstructed (the outlets and inlets are situated on the underside of the stove body).

If the heater is still not operating correctly disconnect the stove and seek expert advice.

Maintenance Instructions

Always remove the plug from the socket-outlet and allow the heater to cool down before cleaning. User maintenance should only be carried out by a competent person.

Light accumulated dust may be removed from the stove with a soft dry cloth.

The exterior surface of the stove can be cleaned with a soft damp cloth (not dripping wet). Dry the exterior surface before operating the heater.

Household glass cleaner can be used on the fire glass.

WARNING!

Do not immerse the heater in water.

Do not use any cleaning chemicals such as detergents and abrasives.

Do not allow the interior to get wet as this could create a hazard.

In the event of malfunction contact the manufacturer, do not try to repair the heater yourself as this may result in a fire hazard or electric shock.

Environment

Fig. 27



Do not dispose of electrical appliances as unsorted municipal waste. Use separate collection facilities. Contact your local government for information regarding the collection services available in your local area. If electrical appliances are disposed of in landfills or dumps hazardous substances can leak into the groundwater and get into the food chain, thus damaging your health and wellbeing. When replacing old appliances with new ones the retailer is legally obligated to take away your old stove for disposal free of charge.

Warranty

Congratulations on the purchase of your electric stove. This stove by BFM Europe Ltd is guaranteed for 5 years from the date of purchase against faulty materials or workmanship. Please note the 5 year guarantee comprises of 24 months of parts and labour with an extended 36 months of parts only. If your stove is found to be defective within 24 months from the date of purchase, we or our authorized agent will repair the faulty component on site.

This warranty does not cover consumable items which have a limited lifespan. If a problem should occur, the nature of the problem together with the date of purchase and installer information should be immediately reported to the retailer that the stove was purchased from. Proof of purchase will be required so the original invoice should be retained.

B-1034302
Issue 2



BFM Europe Ltd
Gordon Banks Drive
Trentham Lakes
Stoke-on-Trent
ST4 4TJ

Technical Queries: 01782 339039
Service Fault Enquiries: 01782 339008

Spare Parts - www.bfm-partfinder.co.uk