



CELSI 
...the future of fire



PREMIUM ELECTRIC FIRES COLLECTION 2023





WELCOME TO CELSI

At Celsi we know how important it is to create a stylish and relaxing living environment. That's why we've developed this collection of premium electric fires.

I believe our success stems from a combination of innovative design, investment in technology and the highest quality manufacturing standards. To reflect my belief in their quality and durability, Celsi fires carry a minimum of 2 years guarantee, with some models extended by a further 3* years limited warranty.

This brochure has been designed to make the purchase of your new Celsi heater as simple as possible.

I hope you find it both informative and inspiring.

There is no more versatile fuel for home heating than electricity

With a range that includes beautifully crafted electric suites, feature wall smart fires, classically styled hearth inset fires, and contemporary stove designs, there is a Celsi fire to suit any home. Best of all you are free to enjoy any of these fantastic heating appliances in any room in your home simply by plugging into the nearest mains socket.

To learn more about the features and benefits of owning a Celsi electric fire please sit back and take a few moments to look through our Advanced Features section, along with our technology introduction to assist you in choosing your perfect Celsi fire experience.

ADVANCED FEATURES



THERMOSTATIC HEATING

Pre-set your heat comfort level for automatic temperature control via the handset.



TIMER FUNCTION

Programmable 7-day heating timer with hourly on/off control.
Up to 8 hrs sleep timer facility available on some models.



LED EFFICIENCY

From controllable flame picture and fuel bed brightness, to colour changing mood lighting, our onboard LED's ensure effective energy saving low power consumption.



ISOFLAME

Independent flame effect capable of displaying in isolation when no heat is required from the appliance.



CELSI SMART APP

Feature-rich and simple to operate. Control your fire from your smart phone or tablet with full handset functionality.
Download our app! See Page 8



FLAME FUSION

A captivating fusion of soft and natural yellow flames with an attractive flare of blue flame intensity.



COLOUR CYCLE

Fix your favourite or go dynamic as you cycle through an array of impressive colour changing options.



MOOD LIGHTS

Enhance your experience with an ambient stream of colour rich LED back lighting. Select from a choice of colours to compliment both warm and cool home interiors, or simply to suit your mood.



REAL WOOD

100% Real Wood Logs, natural, authentic, and unique. Accept no imitations!



We are confident you are getting a product that is built to last. That's why we offer a 2 Year full Guarantee across our electric fires range, with an extended 3*years limited warranty on selected Celsi models.



ECODESIGN COMPLIANT

Integrated design features for optimal energy saving performance and assurance.



APPROVED

Conformity assessed and certified UK & EU



SUITES Real Wood U-VR Luminaire 800

BUILT-IN FIRES E-VR Commodus smart fires 1000/1250/1600

WALL FIRES U-VR Vader Aleesia

HEARTH FIRES U-VR Camber Satin Silver

STOVES E-VR Rochester

Virtual Reality – True Flame Experience



Open or Glass fronted technology with 'Real Wood Logs', or natural log effects. Incredible illusions of 'Active Blazing Embers' and intense flame captivation. Styles include luxury Limestone Suites, beautiful wall and hearth inset models, all designed to look sensational and create comfortable controllable warmth. See Feature Pages 6-7

Firebeam Suites	
U-VR Firebeam 800/600/800XL/600XL	8-15
Freestanding Suites	
U-VR Luminaire 800/600	16-17
U-VR Skyfall 800/600	18-21
U-VR Orbital 800	22
U-VR Vega	23
U-VR Gemma 800/600	24-25
U-VR Adour Aleesia/Adour Elite/Adour Asencio/Adour	26-31
U-VR Canelo	32
U-VR Elara	33
Limestone Inset Suites	
U-VR Parada Elite	34
U-VR Avignon Elite	35
U-VR Aleesia	36
U-VR Asencio	37
U-VR Angelo	38
U-VR Boticelli	39
U-VR Pablo	40
Wall Inset Fires	
U-VR Elite	41
U-VR Vichy	42
U-VR Metz	43
U-VR Instinct	44
U-VR Evora Asensio & Asensio	45
U-VR Vader Aleesia & Aleesia	46-47
U-VR Celena	48
U-VR Impulse	49
Hearth Inset Fires	
U-VR Arcadia	50
U-VR Decadence	51
U-VR Camber	52
U-VR Frontier	53
U-VR Essence	54
U-VR Designer	55
U-VR Endura	56
U-VR Contemporary	57

Virtual Reality – Smart & Advanced Flame Projection



Smart connectivity, colours, and configuration raise the appearance and functionality of electric fires to a new level. See Feature Pages 74-75

Advanced Flame Projection Technology creates a flame illusion to the front, the centre, and the rear of the fuel bed. This simulates a totally natural log fire effect.

Freestanding Suites - 3 Sided Glass	
E-VR Media 1100/750	58-59
E-VR Carino 1100/750	60-61
E-VR Gemma 1000	62-63
E-VR Orbital 1000	64-65
Wall Mounted Suites - 3 Sided Glass	
E-VR Volare 1100/750	66-68
Built-In Fires - 3 Sided Glass	
E-VR 750	69
E-VR 1100	70-71
E-VR 1400	72-73
E-VR Commodus s1000	76-77
E-VR Commodus s1250	78-79
E-VR Commodus s1600	80-81
Wall Inset Fires	
E-VR Commodus	82
E-VR Vichy	83
Wall Mounted Fires	
E-VR Louvre	84
E-VR Bisilica	85
Hearth Inset Fires	
E-VR Acero	86-87
E-VR Parrilla	88
E-VR Contemporary	89
Stoves	
E-VR Rochester	90-91
E-VR Arundel	92
E-VR Luxima	93

Xtra Dimensional – High Definition Fire



Electriflame XD is a 'Glass Fronted' extra deep fuel effect with high definition 3D flames. The E-XD range features impressive landscape 'hang-on-the-wall' fires framed with natural stone, premier board, and full glass fascias.

Our hearth inset fires and stoves provide a wide selection of designs that complement both modern and traditional home interiors.

Wall Mounted Fires	
E-XD Prestige	94-95
E-XD Black Glass	96
E-XD Royal Botticino	97
E-XD Travertine	98
E-XD Piano Black	99
Hearth Inset Fires	
E-XD Camber	100
E-XD Decadence	101
E-XD Essence	102
E-XD Arcadia	103
E-XD Signature	104-105
E-XD Daisy	106
E-XD Caress	107
E-XD Bauhaus	108-109
Stoves	
Electristove XD Metal 1 & 2	110-111
Electristove XD Glass 1 & 2	112-113

Inspired Flame Effect Technologies



Through illusion and LED light technology beautiful flames emerge to provide a range of distinctive electric fire effects that will bewilder and excite.

Wall Mounted Fires	
Flamonik Rapture	114
Flamonik Enchant	115
Hearth Inset Firesw	
Accent Traditional	116
Accent Infusion	117

DIMENSIONS	118-127
-------------------	---------

REAL WOOD LOGS

NATURAL FIRE RANGE

CELSI have taken Ultiflame Virtual Reality fires to the next level. Our most successful natural flame effect is now further complemented with a maximum depth exciting arrangement of real wood logs fixed into a lively 'Active crystal ember fuel bed'

The fire realism is sensational, and the natural wood log arrangement is visually stunning.

This next generation electric fire effect is available in a range of contemporary Firebeams and Suites, each including integrated dimmable LED lighting.



REAL WOOD

100% Real Wood Logs, natural, authentic, and unique. Accept no imitations!



Page 14

U-VR Firebeam XL 600 Suite



Page 8

U-VR Firebeam 800 Suite



Page 18

U-VR Skyfall 800 Suite



Page 17

U-VR Luminaire 600 Suite



Active Blazing Embers

Our Firebeam models include wall mounted beams smartly framed by sleek glass with chrome fittings that totally complement this product.

For a larger feature wall suite see our 'Firebeam XL' models, these provide a luxury feature fireplace that requires less wall depth for easy installation.

For a completely fuss-free installation our freestanding suites only require the need to place down and plug in.

CELSI Ultiflame VR fires are premium products with integrated design features for optimal energy saving performance and assurance.



Virtual Reality – True Flame Experience

FIREBEAM 800

Ultriflame VR Inset Illumia Suite

Features

- Open fire experience
- Extra deep fuel bed
- Natural real wood logs
- Active crystal embers
- Single or dual colour flame
- LED brightness control
- Thermostatic remote & manual control operation
- Dimmable LED beam lighting



Smooth White



Real Wood Logs



Smooth Mist

Specification

Suite Dimensions: mm	H 540 x W 1200 x D 170
Heat Output	1.0kW - 2.0kW
Suite Finish	<input type="checkbox"/> Smooth White
Painted	<input type="checkbox"/> Smooth Mist



Ecodesign
Compliant



Video

FIREBEAM 600

Ultiflame VR Inset Illumia Suite

Features

- Open fire experience
- Extra deep fuel bed
- Natural real wood logs
- Active crystal embers
- Single or dual colour flame
- LED brightness control
- Thermostatic remote & manual control operation
- Dimmable LED beam lighting



Smooth Mist



Real Wood Logs



Smooth White

Specification

Suite Dimensions: mm	H 615 x W 870 x D 170
Heat Output	1.0kW - 2.0kW
Suite Finish	<input type="checkbox"/> Smooth White
Painted	<input type="checkbox"/> Smooth Mist



Video

WR FIREBEAM XL800

Ultriflame VR Semi-Inset Illumia Suite

Features

- Open fire experience
- Extra deep fuel bed
- Natural real wood logs
- Active crystal embers
- Single or dual colour flame
- LED brightness control
- Thermostatic remote & manual control operation
- Dimmable LED beam lighting



Real Wood Logs



Specification

Suite Dimensions: mm	H 697 x W 1302 x D 213
Heat Output	1.0kW - 2.0kW
Suite Finish Painted	<input type="checkbox"/> Smooth White



Video

WR FIREBEAM XL600

Ultriflame VR Semi-Inset Illumia Suite

Features

- Open fire experience
- Extra deep fuel bed
- Natural real wood logs
- Active crystal embers
- Single or dual colour flame
- LED brightness control
- Thermostatic remote & manual control operation
- Dimmable LED beam lighting



Real Wood Logs



Specification

Suite Dimensions: mm	H 697 x W 1302 x D 213
Heat Output	1.0kW - 2.0kW
Suite Finish	<input type="checkbox"/> Smooth White
Painted	



Video

LUMINAIRE 800

Ultriflame VR Freestanding Illumia Suite



Video



Features

- Open fire experience
- Extra deep fuel bed
- Natural real wood logs
- Active crystal embers
- Single or dual colour flame
- LED brightness control
- Thermostatic remote & manual control operation
- Dimmable LED suite lighting

Real Wood Logs



Specification

Suite Dimensions: mm	H 1005 x W 1478 x D 400
Heat Output	1.0kW - 2.0kW
Suite Finish Painted	<input type="checkbox"/> Smooth White

LUMINAIRE 600

Ultriflame VR Freestanding Illumia Suite



Video



Features

- Open fire experience
- Extra deep fuel bed
- Natural real wood logs
- Active crystal embers
- Single or dual colour flame
- LED brightness control
- Thermostatic remote & manual control operation
- Dimmable LED suite lighting

Real Wood Logs



Specification

Suite Dimensions: mm	H 1108x W 1350 x D 400
Heat Output	1.0kW - 2.0kW
Suite Finish Painted	<input type="checkbox"/> Smooth White

WR SKYFALL 800

Ultiflame VR Freestanding Illumia Suite

Features

- Open fire experience
- Extra deep fuel bed
- Natural real wood logs
- Active crystal embers
- Single or dual colour flame
- LED brightness control
- Thermostatic remote & manual control operation
- Dimmable LED suite lighting



Smooth White



Real Wood Logs



Smooth White & Mist

Specification

Suite Dimensions: mm	H 775 x W 1480 x D 375
Heat Output	1.0kW - 2.0kW
Suite Finish	<input type="checkbox"/> Smooth White
Painted	<input type="checkbox"/> Smooth White & Mist



Video

SKYFALL 600

Ultiflame VR Freestanding Illumia Suite

Features

- Open fire experience
- Extra deep fuel bed
- Natural real wood logs
- Active crystal embers
- Single or dual colour flame
- LED brightness control
- Thermostatic remote & manual control operation
- Dimmable LED suite lighting



Smooth White & Mist



Real Wood Logs



Smooth White & Mist

Specification

Suite Dimensions: mm	H 877 x W 1113 x D 375
Heat Output	1.0kW - 2.0kW
Suite Finish	<input type="checkbox"/> Smooth White
Painted	<input type="checkbox"/> Smooth White & Mist



Video

VR ORBITAL 800

Ultiflame VR Freestanding Illumia Suite



Video



Smooth Mist

Features

- Open fire experience
- Dimmable LED surround lighting
- Customisable fuel effect
- Silver birch logs
- Crystal ash embers
- Single or dual colour flame
- LED brightness control
- Thermostatic remote & manual control operation



Smooth Cream



Smooth White

Suite Finishes

- Painted
- Smooth White
 - Smooth Mist
 - Smooth Cream

Specification

Suite Dimensions: mm	H 850 x W 1466 x D 360
Heat Output	0.8kW - 1.6kW

VR VEGA

Ultiflame VR Freestanding Illumia Suite



Video



Features

- Open fire experience
- Customisable fuel effect
- Silver birch logs
- Crystal ash embers
- Single or dual colour flame
- LED brightness control
- Thermostatic remote & manual control operation



Specification

Suite Dimensions: mm	H 892 x W 1430 x D 330
Heat Output	0.8kW - 1.6kW

Suite Finishes

- Painted Surround
Black interior
- Smooth White

VR GEMMA 800

Ultriflame VR Freestanding Illumia Suite

Features

- Open fire experience
- Dimmable LED surround lighting
- Customisable fuel effect
- Silver birch logs
- Crystal ash embers
- Single or dual colour flame
- LED brightness control
- Thermostatic remote & manual control operation



Smooth White



Textured Black & White



Textured White

Specification

Suite Dimensions: mm	H 740 x W 1465 x D 360
Heat Output	0.8kW - 1.6kW
Suite Finish Painted	<input type="checkbox"/> Smooth White <input checked="" type="checkbox"/> Textured White <input type="checkbox"/> Textured Black



Video

VR GEMMA 600

Ultiflame VR Freestanding Illumia Suite



Video



Textured White

Features

- Open Fronted Fire
- Dimmable LED surround lighting
- Customisable fuel effect
- Silver birch logs
- Crystal ash embers
- Single or dual colour flame
- LED brightness control
- Thermostatic remote & manual control operation



Smooth White



Textured Black & White

Suite Finishes

Painted

- Smooth White
- Textured White
- Textured Black

Specification

Suite Dimensions: mm	H 835 W 1185 D 360
Heat Output	0.8kW - 1.6kW

VR ADOUR ALEESIA

Ultiflame VR Freestanding Illumia Suite



Video



Features

- Glass Fronted Fire
- Dimmable LED surround lighting
- Customisable fuel effect
- Silver birch logs
- Crystal ash embers
- Single or dual colour flame
- LED brightness control
- Thermostatic remote & manual control operation



Flame Fusion – dual colour



Specification

Suite Dimensions: mm	H 990 x W 1465 x D 380
Heat Output	0.8kW - 1.6kW

Suite Finishes

Painted

- Smooth White

Smooth White



ADOUR ELITE

Ultriflame VR Freestanding Illumia Suite

Features

- Open fire experience
- Dimmable LED surround lighting
- Customisable fuel effect
- Silver birch logs
- Crystal ash embers
- Single or dual colour flame
- LED brightness control
- Thermostatic remote & manual control operation



Smooth Mist



Smooth Cream



Video

Specification

Suite Dimensions: mm	H 990 x W 1465 x D 380
Heat Output	0.8kW - 1.6kW
Suite Finishes Painted	<input type="checkbox"/> Smooth White <input type="checkbox"/> Smooth Mist <input type="checkbox"/> Smooth Cream

ADOUR ASENCIO

Ultriflame VR Freestanding Illumia Suite



Video



Smooth White

Features

- Glass Fronted Fire
- Dimmable LED surround lighting
- Customisable fuel effect
- Silver birch logs
- Crystal ash embers
- Single or dual colour flame
- LED brightness control
- Thermostatic remote & manual control operation

Flame Fusion – dual colour



Specification

Suite Dimensions: mm	H 1090 x W 1340 x D 380
Heat Output	0.8kW – 1.6kW

Suite Finishes

Painted surround
Black interior and hearth

Smooth White

ADOUR

Ultriflame VR Freestanding Illumia Suite



Video



Smooth White

Features

- Open fire experience
- Dimmable LED surround lighting
- Customisable fuel effect
- Silver birch logs
- Crystal ash embers
- Single or dual colour flame
- LED brightness control
- Thermostatic remote & manual control operation



Smooth Cream



Smooth Mist



Specification

Suite Dimensions: mm	H 1090 x W 1340 x D 380
Heat Output	0.8kW – 1.6kW

Suite Finishes

Painted surround
Black interior and hearth

- Smooth White
 Smooth Mist
 Smooth Cream



Video



Features

- Open fire experience
- Dimmable LED surround lighting
- Customisable fuel effect
- Silver birch logs
- Crystal ash embers
- Single or dual colour flame
- LED brightness control
- Thermostatic remote & manual control operation



Specification

Suite Dimensions: mm	H 1090 W 1340 D 340
Heat Output	0.8kW - 1.6kW

Suite Finishes

Painted Surround Black interior	<input type="checkbox"/> Smooth White
------------------------------------	---------------------------------------



Video



Features

- Open fire experience
- Customisable fuel effect
- Silver birch logs
- Crystal ash embers
- Single or dual colour flame
- LED brightness control
- Thermostatic remote & manual control operation



Specification

Suite Dimensions: mm	H 892 x W 1228 x D 330
Heat Output	0.8kW - 1.6kW



Smooth Cream



Smooth White

Suite Finishes

Painted Surround Black interior	<input type="checkbox"/> Smooth White
	<input type="checkbox"/> Smooth Mist
	<input type="checkbox"/> Smooth Cream

PARADA ELITE

Ultiflame VR Inset Limestone Illumia Suite



Video



Features

- Open fire experience
- Dimmable LED surround lighting
- Customisable fuel effect
- Silver birch logs
- Crystal ash embers
- Single or dual colour flame
- LED brightness control
- Thermostatic remote & manual control operation
- Available in two sizes



Specification

Suite Dimensions: mm	54" 58"	H 990 x W 1350 x D 400 H 990 x W 1464 x D 400
Heat Output	0.8kW – 1.6kW	

Suite Finish

Natural Limestone

AVIGNON ELITE

Ultiflame VR Inset Limestone Suite



Video



Features

- Open fire experience
- Customisable fuel effect
- Silver birch logs
- Crystal ash embers
- Single or dual colour flame
- LED brightness control
- Thermostatic remote & manual control operation
- Available in two sizes



Specification

Suite Dimensions: mm	54" 58"	H 990 x W 1350 x D 380 H 990 x W 1464 x D 380
Heat Output	0.8kW – 1.6kW	

Suite Finish

Natural Limestone



Video



Features

- Glass Fronted Fire
- Dimmable LED surround lighting
- Customisable fuel effect
- Silver birch logs
- Crystal ash embers
- Single or dual colour flame
- LED brightness control
- Thermostatic remote & manual control operation
- Available in two sizes



Specification

Suite Dimensions: mm	54" 58"	H 1050 x W 1370 x D 400 H 1050 x W 1470 x D 400
Heat Output	0.8kW - 1.6kW	

Suite Finish

Natural Limestone



Video



Features

- Glass Fronted Fire
- Customisable fuel effect
- Silver birch logs
- Crystal ash embers
- Single or dual colour flame
- LED brightness control
- Thermostatic remote & manual control operation



Specification

Suite Dimensions: mm	H 1095 x W 1376 x D 380	
Heat Output	0.8kW - 1.6kW	

Suite Finish

Natural Limestone



Video



Features

- Open fire experience
- Customisable fuel effect
- Silver birch logs
- Crystal ash embers
- Single or dual colour flame
- LED brightness control
- Thermostatic remote & manual control operation



Specification

Suite Dimensions: mm	H 995 x W 1300 x D 380
Heat Output	0.8kW - 1.6kW

Suite Finish

Natural Limestone



Video



Features

- Open fire experience
- Customisable fuel effect
- Silver birch logs
- Crystal ash embers
- Single or dual colour flame
- LED brightness control
- Thermostatic remote & manual control operation



Specification

Suite Dimensions: mm	H 980 x W 1280 x D 380
Heat Output	0.8kW - 1.6kW

Suite Finish

Natural Limestone



VR PABLO

Ultiflame VR Inset Limestone Suite



Video



Features

- Open fire experience
- Customisable fuel effect
- Silver birch logs
- Crystal ash embers
- Single or dual colour flame
- LED brightness control
- Thermostatic remote & manual control operation



Specification

Suite Dimensions: mm	H 980 x W 1220 x D 410
Heat Output	0.8kW - 1.6kW

Suite Finish

Natural  Limestone

VR ELITE

Ultiflame VR Wall Inset Fire



Video



Features

- Open fire experience
- Customisable fuel effect
- Silver birch logs
- Crystal ash embers
- Single or dual colour flame
- LED brightness control
- Thermostatic remote & manual control operation



Specification

Fire Dimensions: mm	H 352 x W 843 x D 182
Heat Output	0.8kW - 1.6kW



Ultiflame VR Wall Inset Fire



Video

Satin Silver



Features

- Open fire experience
- Customisable fuel effect
- Silver birch logs
- Crystal ash embers
- Single or dual colour flame
- LED brightness control
- Thermostatic remote & manual control operation



Black Textured



Satin Champagne

Finishes

- Steel Fabricated Fascia
 - Satin Silver
 - Satin Champagne
 - Black Textured
- Brushed Metallic or Black Textured Paint

Specification

Dimensions: mm	H 540 x W 1490 x D 71
Heat Output	0.8kW - 1.6kW



Ultiflame VR Wall Inset Fire



Video

Satin Champagne



Features

- Open fire experience
- Customisable fuel effect
- Silver birch logs
- Crystal ash embers
- Single or dual colour flame
- LED brightness control
- Thermostatic remote & manual control operation



Satin Silver

Specification

Dimensions: mm	H 540 x W 1490 x D 22.5
Heat Output	0.8kW - 1.6kW

Finishes

- Steel Fabricated Fascia
 - Satin Silver
 - Satin Champagne
- Brushed Metallic

INSTINCT

Ultiflame VR Wall Inset Fire



Video



Satin Champagne

Features

- Open fire experience
- Customisable fuel effect
- Silver birch logs
- Crystal ash embers
- Single or dual colour flame
- LED brightness control
- Thermostatic remote & manual control operation



Satin Black



Specification

Dimensions: mm	H 647 x W 1138 x D 60
Heat Output	0.8kW - 1.6kW

Finishes

- Steel Fabricated Fascia
- Steel Fabricated Fascia Brushed Metallic
- Satin Champagne
- Satin Black

EVORA ASENCIO & ASENCIO

Ultiflame VR Wall Inset Fire



Video



Evora Asencio

Features

- Glass fronted fire
- Customisable fuel effect
- Silver birch logs
- Crystal ash embers
- Single or dual colour flame
- LED brightness control
- Thermostatic remote & manual control operation



Asencio trimless installation



Specification

Dimensions: mm	Evora Asencio H 768 x W 762 x D 19
	Asencio H 570x W 570 x D 183
Heat Output	0.8kW - 1.6kW

Finish

- Steel Fabricated Fascia
- Dual Metallic
- Black Nickel & Chrome

Vader Aleesia Black Nickel & Black



VADER ALEESIA & ALEESIA

Ultriflame VR Wall Inset Fire

Features

- Glass fronted fire
- Customisable fuel effect
- Silver birch logs
- Crystal ash embers
- Single or dual colour flame
- LED brightness control
- Thermostatic remote & manual control operation



Vader Aleesia Black Nickel & Chrome



Aleesia trimless installation



Video

Specification

Dimensions: mm	Vader Aleesia H 683 x W 963 x D 21 Aleesia H 490 x W 770 x D 183
Heat Output	0.8kW - 1.6kW
Finishes	<div style="display: flex; gap: 10px;"> <div style="width: 15px; height: 15px; background-color: black; border: 1px solid black;"></div> Black Nickel & Black </div> <div style="display: flex; gap: 10px;"> <div style="width: 15px; height: 15px; background-color: black; border: 1px solid black;"></div> Black Nickel & Chrome </div>
Steel Fabricated Fascia	
Dual Metallic	

CELENA

Ultiflame VR Wall Inset Fire



Video



Features

- Open fire experience
- Customisable fuel effect
- Silver birch logs
- Crystal ash embers
- Single or dual colour flame
- LED brightness control
- Thermostatic remote & manual control operation



Specification

Fire Dimensions: mm	H 447 x W 560 x D 182
Heat Output	0.8kW - 1.6kW

IMPULSE

Ultiflame VR Wall Inset Fire



Video



Satin Silver

Features

- Open fire experience
- Customisable fuel effect
- Silver birch logs
- Crystal ash embers
- Single or dual colour flame
- LED brightness control
- Thermostatic remote & manual control operation



Specification

Dimensions: mm	H 742 x W 860 x D 60
Heat Output	0.8kW - 1.6kW



Satin Black

Finishes

Steel Fabricated Fascia
Brushed Metallic





Video



Black & Gold

Features

- Open fire experience
- Customisable fuel effect
- Silver birch logs
- Crystal ash embers
- Single or dual colour flame
- LED brightness control
- Thermostatic remote & manual control operation



Optional Extras

75mm Spacer frame
For flat wall installation



Black & Chrome

Finishes

High Quality Cast Iron Fascia
Paint and Metallic Plated

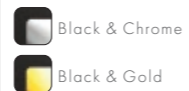

Specification

Dimensions: mm	H 612 x W 528 x D 154
Heat Output	0.75kW - 1.5kW



Video



Chrome

Features

- Open fire experience
- Customisable fuel effect
- Silver birch logs
- Crystal ash embers
- Single or dual colour flame
- LED brightness control
- Thermostatic remote & manual control operation



Optional Extras

75mm Spacer frame
For flat wall installation



Gold



Black Nickel

Specification

Dimensions: mm	H 630 x W 528.5 x D 151
Heat Output	0.75kW - 1.5kW

Finishes

High Quality Cast Iron Fascia
Metallic Plated

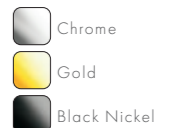



Video



Satin Silver

Features

- Open fire experience
- Customisable fuel effect
- Silver birch logs
- Crystal ash embers
- Single or dual colour flame
- LED brightness control
- Thermostatic remote & manual control operation



Optional Extras

75mm Spacer frame
For flat wall installation



Satin Champagne

Black Textured

Finishes

Anodised Aluminium Fascia
Brushed Metallic or
Black Textured Paint

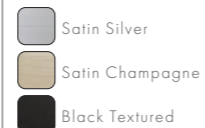

Specification

Dimensions: mm	H 619 x W 537 x D 135
Heat Output	0.75kW - 1.5kW



Video



Features

- Open fire experience
- Customisable fuel effect
- Silver birch logs
- Crystal ash embers
- Single or dual colour flame
- LED brightness control
- Thermostatic remote & manual control operation



Optional Extras

75mm Spacer frame
For flat wall installation

Specification

Dimensions: mm	H 617 x W 541 x D 131
Heat Output	0.75kW - 1.5kW

Finish

Steel Fabricated Fascia
Dual Finish
Paint & Metallic

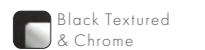



Video



Black

Features

- Open fire experience
- Customisable fuel effect
- Silver birch logs
- Crystal ash embers
- Single or dual colour flame
- LED brightness control
- Thermostatic remote & manual control operation



Optional Extras

75mm Spacer frame
For flat wall installation



Satin Silver

Specification

Dimensions: mm	H 619 x W 537 x D 127
Heat Output	0.75kW - 1.5kW

Finishes

Steel Fabricated Fascia
Brushed Metallic
Smooth Black Paint

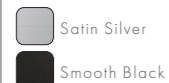

Video



Black Nickel & Chrome

Features

- Open fire experience
- Customisable fuel effect
- Silver birch logs
- Crystal ash embers
- Single or dual colour flame
- LED brightness control
- Thermostatic remote & manual control operation



Optional Extras

75mm Spacer frame
For flat wall installation



Chrome & Black

Specification

Dimensions: mm	H 599 x W 498 x D 129
Heat Output	0.75kW - 1.5kW

Finishes

Steel Fabricated Fascia
Dual Metallic





Video



Chrome

Features

- Open fire experience
- Customisable fuel effect
- Silver birch logs
- Crystal ash embers
- Single or dual colour flame
- LED brightness control
- Thermostatic remote & manual control operation



Optional Extras

75mm Spacer frame
For flat wall installation



Black

Finishes

Steel Fabricated Fascia
Metallic or Smooth Black Paint

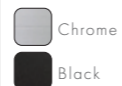

Specification

Dimensions: mm	H 598 x W 497 x D 126
Heat Output	0.75kW - 1.5kW



Video



Satin Silver

Features

- Open fire experience
- Customisable fuel effect
- Silver birch logs
- Crystal ash embers
- Single or dual colour flame
- LED brightness control
- Thermostatic remote & manual control operation



Optional Extras

75mm Spacer frame
For flat wall installation



Satin Champagne

Finishes

Steel Fabricated Fascia
Brushed Metallic

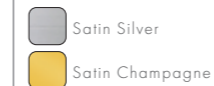

Specification

Dimensions: mm	H 598 x W 493 x D 132
Heat Output	0.75kW - 1.5kW

ER MEDIA 1100

Electrifiame VR Freestanding Illumia Suite



Video



Features

- Flame Projection Technology
- 3 sided glass fire
- Dimmable LED surround lighting
- Media storage
- Customisable fuel effect
- Silver birch logs
- Crystal ash embers
- Single or dual colour flame
- LED brightness control
- Thermostatic remote & manual control operation

Flame Projection Technology



Specification

Suite Dimensions: mm	H 1126 x W 1595 x D 408
Heat Output	1.0kW - 2.0kW
Suite Finish Painted	<input type="checkbox"/> Smooth White

ER MEDIA 750

Electrifiame VR Freestanding Illumia Suite



Video



Features

- Flame Projection Technology
- 3 sided glass fire
- Dimmable LED surround lighting
- Media storage
- Customisable fuel effect
- Silver birch logs
- Crystal ash embers
- Single or dual colour flame
- LED brightness control
- Thermostatic remote & manual control operation

Optional Extras

Woodland logs fuel effect



Specification

Suite Dimensions: mm	H 1126 x W 1400 x D 408
Heat Output	1.0kW - 2.0kW
Suite Finish Painted	<input type="checkbox"/> Smooth White

ER CARINO 1100

Electrifiame VR Freestanding Illumia Suite



Video



Features

- Flame Projection Technology
- 3 sided glass fire
- Dimmable LED surround lighting
- Customisable fuel effect
- Silver birch logs
- Crystal ash embers
- Single or dual colour flame
- LED brightness control
- Thermostatic remote & manual control operation

Flame Projection Technology



Specification

Suite Dimensions: mm	H 840 x W 1467 x D 370
Heat Output	1.0kW - 2.0kW
Suite Finish	<input type="checkbox"/> Smooth White
Painted	

ER CARINO 750

Electrifiame VR Freestanding Illumia Suite



Video



Features

- Flame Projection Technology
- 3 sided glass fire
- Dimmable LED surround lighting
- Customisable fuel effect
- Silver birch logs
- Crystal ash embers
- Single or dual colour flame
- LED brightness control
- Thermostatic remote & manual control operation

Optional Extras

Woodland logs fuel effect



Specification

Suite Dimensions: mm	H 840 x W 1118 x D 370
Heat Output	1.0kW - 2.0kW
Suite Finish	<input type="checkbox"/> Smooth White
Painted	

ER GEMMA 1000

Electriflame VR Freestanding Illumia Suite

Features

- Flame Projection Technology
- Glass fronted fire
- Dimmable LED surround lighting
- Customisable fuel effect
- Silver birch logs
- Crystal ash embers
- Single or dual colour flame
- LED brightness control
- Thermostatic remote & manual control operation



Smooth White



Textured Black & White



Specification

Suite Dimensions: mm	H 724 x W 1565 x D 360
Heat Output	0.8kW - 1.6kW
Suite Finishes Painted	<input type="checkbox"/> Smooth White <input checked="" type="checkbox"/> Textured White <input type="checkbox"/> Textured Black



Video

ER ORBITAL 1000

Electrifiame VR Freestanding Illumia Suite

Features

- Flame Projection Technology
- Glass fronted fire
- Dimmable LED surround lighting
- Customisable fuel effect
- Silver birch logs
- Crystal ash embers
- Single or dual colour flame
- LED brightness control
- Thermostatic remote & manual control operation



Smooth Mist



Smooth White

Specification

Suite Dimensions: mm	H 855 x W 1600 x D 360
Heat Output	0.8kW - 1.6kW
Suite Finishes Painted	<input type="checkbox"/> Smooth White <input type="checkbox"/> Smooth Mist



Video

ER VOLARE 1100

Electrifiame VR Wall Mounted Illumia Suite

Features

- Flame Projection Technology
- 3 sided glass fire
- Dimmable LED surround lighting
- Customisable fuel effect
- Silver birch logs
- Crystal ash embers
- Single or dual colour flame
- LED brightness control
- Thermostatic remote & manual control operation
- Includes wall fixing bracket



Flame Projection Technology



Specification

Suite Dimensions: mm	H 721 x W 1595 x D 406
Heat Output	1.0kW - 2.0kW
Suite Finish Painted	<input type="checkbox"/> Smooth White



Video

ER VOLARE 750

Electrifiame VR Wall Mounted Illumia Suite



Video



Features

- Flame Projection Technology
- 3 sided glass fire
- Dimmable LED surround lighting
- Customisable fuel effect
- Silver birch logs
- Crystal ash embers
- Single or dual colour flame
- LED brightness control
- Thermostatic remote & manual control operation
- Includes wall fixing bracket

Optional Extras

Woodland logs fuel effect



Specification

Suite Dimensions: mm	H 721 x W 1400 x D 406
Heat Output	1.0kW - 2.0kW
Suite Finish Painted	<input type="checkbox"/> Smooth White

ER 750

Electrifiame VR Built-In 3 Sided Glass Fire



Video



Features

- Flame Projection Technology
- 3 sided glass fire
- Customisable fuel effect
- Silver birch logs
- Crystal ash embers
- Single or dual colour flame
- LED brightness control
- Thermostatic remote & manual control operation
- Side blanking for 2 & 1 sided installations

Optional Extras

Woodland logs fuel effect



Specification

Fire Dimensions: mm	H 374 x W 780 x D 275
Heat Output	0.8kW - 1.6kW

ER 1100

Electriflame VR Built-In 3 Sided Glass Fire

Features

- Flame Projection Technology
- 3 sided glass fire
- Customisable fuel effect
- Silver birch logs
- Crystal ash embers
- Single or dual colour flame
- LED brightness control
- Thermostatic remote & manual control operation
- Side blanking for 2 & 1 sided installations



Flame Projection Technology



Specification

Fire Dimensions: mm	H 374 x W 1130 x D 275
Heat Output	1.0kW - 2.0kW



Video



ER 1400

Electrifiame VR Built-In 3 Sided Glass Fire

Features

- Flame Projection Technology
- 3 sided glass fire
- Customisable fuel effect
- Silver birch logs
- Crystal ash embers
- Single or dual colour flame
- LED brightness control
- Thermostatic remote & manual control operation
- Side blanking for 2 & 1 sided installations



Flame Projection Technology



Video

Specification

Fire Dimensions: mm	H 375 x W 1430 x D 275
Heat Output	1.0kW - 2.0kW

CELSI

SMART FIRES

CELSI SMART Electriflame Virtual Reality fires.

Next generation Flame Projection technology creates the flame illusion to the front, the centre, and the rear of the fuel bed. This simulates a totally natural log fire effect that raise the appearance and functionality of electric fires to a new level.



COLOUR

E-VR Smart Fires have **16 individual colour vibrant options** to customise the light ambience on flames, logs, and crystal embers.

Using the handset, or Smart App select from a range of pre-set colour modes to simplify your choice, or enjoy a slow cycle through the colour spectrum in our fully immersive **Animation mode**.

CONFIGURATION

This range of **built-in 3-sided glass models** offer the perfect solution for your feature wall. Available in three sizes **1000, 1250, and 1600**.

E-VR Commodus Smart fires are supplied with side blanking panels giving you the option to customise your installation by converting from a 3-sided fire, to a 2-sided left or right configuration, or to simply install as a single glass fronted wall inset fire.

CONNECTIVITY

CELSI SMART APP

Feature-rich and simple to operate. Control your fire from your smart phone or tablet with **full handset functionality**.



Scan the QR code to download our app



ER ELECTRIFLAME®VR

Virtual Reality – Smart Flame Projection



s1000
Page 76

E-VR Commodus s1000. Single sided installation



s1250
Page 78

E-VR Commodus s1250. 2 Sided installation



s1600
Page 80

E-VR Commodus s1600. 3 Sided installation

ER COMMODUS s1000

Electriflame VR Built-In 3 Sided Glass Smart Fire

Features

- Flame Projection Technology
- 3 sided glass smart fire
- Customisable fuel effect
- Silver birch logs
- Crystal ash embers
- 16 Colour cycle options
- LED brightness control
- Thermostatic remote & manual control operation
- Side blanking for 2 & 1 sided installations



CELSI SMART APP

Feature-rich and simple to operate. Control your fire from your smart phone or tablet with full handset functionality. See page 8 to download the app.

CELSI Smart Fires have 16 individual colour vibrant options to customise the light ambience on flames, logs, and crystal embers.

Select from a range of pre-set colour modes to simplify your choice, or enjoy a slow cycle through the colour spectrum in our fully immersive Animation mode.

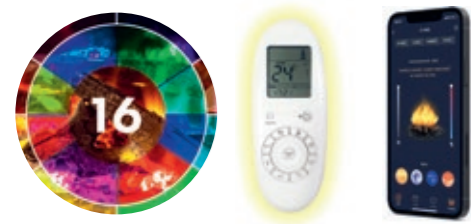

Optional 2-sided glass Installation

Specification

Fire Dimensions: mm	H 330 x W 1000 x D 219
Heat Output	0.8kW - 1.6kW



Video



ER COMMODUS s1250

Electriflame VR Built-In 3 Sided Glass Smart Fire

Features

- Flame Projection Technology
- 3 sided glass smart fire
- Customisable fuel effect
- Silver birch logs
- Crystal ash embers
- 16 Colour cycle options
- LED brightness control
- Thermostatic remote & manual control operation
- Side blanking for 2 & 1 sided installations



CELSI SMART APP

Feature-rich and simple to operate. Control your fire from your smart phone or tablet with full handset functionality. See page 8 to download the app.

CELSI Smart Fires have 16 individual colour vibrant options to customise the light ambience on flames, logs, and crystal embers. Select from a range of pre-set colour modes to simplify your choice, or enjoy a slow cycle through the colour spectrum in our fully immersive Animation mode.



Optional 2-sided glass Installation



Video

Specification

Fire Dimensions: mm	H 330 x W 1600 x D 219
Heat Output	1.0kW - 2.0kW



ER COMMODUS s1600

Electriflame VR Built-In 3 Sided Glass Smart Fire

Features

- Flame Projection Technology
- 3 sided glass smart fire
- Customisable fuel effect
- Silver birch logs
- Crystal ash embers
- 16 Colour cycle options
- LED brightness control
- Thermostatic remote & manual control operation
- Side blanking for 2 & 1 sided installations



CELSI SMART APP

Feature-rich and simple to operate. Control your fire from your smart phone or tablet with full handset functionality. See page 8 to download the app.

CELSI Smart Fires have 16 individual colour vibrant options to customise the light ambience on flames, logs, and crystal embers. Select from a range of pre-set colour modes to simplify your choice, or enjoy a slow cycle through the colour spectrum in our fully immersive Animation mode.



Video

Specification

Fire Dimensions: mm	H 330 x W 1600 x D 219
Heat Output	1.0kW – 2.0kW

ER COMMODUS

Electriflame VR Wall Inset Fire



Video



Features

- Flame Projection Technology
- Glass fronted fire
- Customisable fuel effect
- Silver birch logs
- Crystal ash embers
- Single or dual colour flame
- LED brightness control
- Thermostatic remote & manual control operation

Flame Projection Technology



Specification

Fire Dimensions: mm	H 330 x W 981 x D 169
Heat Output	0.8kW – 1.6kW

ER VICHY

Electriflame VR Wall Inset Fire



Video



Satin Champagne

Features

- Flame Projection Technology
- Glass fronted fire
- Customisable fuel effect
- Silver birch logs
- Crystal ash embers
- Single or dual colour flame
- LED brightness control
- Thermostatic remote & manual control operation



Satin Silver



Specification

Dimensions: mm	H 523 x W 1653 x D 87
Heat Output	0.8kW – 1.6kW

Finishes

Steel Fabricated Fascia	Satin Silver
Brushed Metallic	Satin Champagne



Video



Features

- Flame Projection Technology
- Glass fronted fire
- Customisable fuel effect
- Woodland logs
- Crystal ash embers
- Single or dual colour flame
- LED brightness control
- Thermostatic remote & manual control operation
- Includes wall fixing bracket



Specification

Dimensions: mm	H 519 x W 1102 x D 201
Heat Output	0.8kW - 1.6kW

Finish

Steel Fabricated & Glass Fascia Dual Finish Brushed Metallic	Satin Silver & Black Glass
--------------------------------------------------------------------	----------------------------



Video



Satin Champagne & Black

Features

- Flame Projection Technology
- Glass fronted fire
- Customisable fuel effect
- Silver birch logs
- Crystal ash embers
- Single or dual colour flame
- LED brightness control
- Thermostatic remote & manual control operation
- Includes wall fixing bracket
- Wall inset option



Specification

Dimensions: mm	H 570 x W 1400 x D 90
Heat Output	0.8kW - 1.6kW



Satin Silver & Black

Finishes

Steel Fabricated Fascia Dual Finished Brushed Metallic Black Painted	Satin Silver & Black Satin Champagne & Black
-------------------------------------------------------------------------------	-------------------------------------------------



Chrome & Black Nickel

ER ACERO

Electriflame VR Hearth Inset Fire

Features

- Aspirational 26 inch fascia
- Flame Projection Technology
- Extra wide glass fronted fire
- Customisable fuel effect
- Silver birch logs
- Crystal ash embers
- Single or dual colour flame
- LED brightness control
- Thermostatic remote & manual control operation



THERMO-STATIC



7 DAY TIMER



ENERGY SAVING



ISO FLAME



FLAME FUSION



Chrome & Satin Silver

Flame Projection Technology



Video

Specification

Dimensions: mm	H 655 x W 657 x D 67
Heat Output	0.8kW - 1.6kW
Finishes	<input type="checkbox"/> Chrome & Satin Silver <input type="checkbox"/> Chrome & Black Nickel
Steel Fabricated Fascia	
Dual Finished	
Twin Metallic	



Video



Features

- Flame Projection Technology
- Extra wide glass fronted fire
- Customisable fuel effect
- Silver birch logs
- Crystal ash embers
- Single or dual colour flame
- LED brightness control
- Thermostatic remote & manual control operation



Satin Silver

Finishes

- Steel Fabricated Fascia
Brushed Metallic
- Satin Silver
 - Satin Champagne

Specification

Dimensions: mm	H 602 x W 544 x D 90
Heat Output	0.75kW - 1.5kW



Video



Features

- Flame Projection Technology
- Extra wide glass fronted fire
- Customisable fuel effect
- Silver birch logs
- Crystal ash embers
- Single or dual colour flame
- LED brightness control
- Thermostatic remote & manual control operation



Finishes

- Steel Fabricated Fascia
Brushed Metallic
- Satin Champagne

Specification

Dimensions: mm	H 602 x W 544 x D 90
Heat Output	0.75kW - 1.5kW

Electriflame VR Stove

Features

- Flame Projection Technology
- Tough steel body
- Curved door design
- Customisable fuel effect
- Silver birch logs
- Crystal ash embers
- Single or dual colour flame
- LED brightness control
- Thermostatic remote & manual control operation



Optional Extras

- Woodland logs fuel effect
- Decorative Steel Flue Pipe Accessories



Specification

Dimensions: mm	H 606 x W 532 x D 372
Heat Output	1.0kW - 2.0kW
Finish Steel Fabricated Painted	 Black



Video



Video



Features

- Flame Projection Technology
- Tough steel body
- Customisable fuel effect
- Silver birch logs
- Crystal ash embers
- Single or dual colour flame
- LED brightness control
- Thermostatic remote & manual control operation



Optional Extras

- Woodland logs fuel effect
- Decorative Steel Flue Pipe Accessories



Finish

Steel Fabricated Painted  Black

Specification

Dimensions: mm	H 582 x W 430 x D 389
Heat Output	0.75kW - 1.5kW



Video



Features

- Flame Projection Technology
- Tough steel body
- Customisable fuel effect
- Silver birch logs
- Crystal ash embers
- Single or dual colour flame
- LED brightness control
- Thermostatic remote & manual control operation



Optional Extras

- Woodland logs fuel effect
- Decorative Steel Flue Pipe Accessories



Finish

Steel Fabricated Painted  Black

Specification

Dimensions: mm	H 595 x W 471 x D 359
Heat Output	0.75kW - 1.5kW

EXO PRESTIGE

Electriflame XD Wall Mounted Fire

Features

- Glass fronted fire
- High definition effect
- Extra deep 3D coals
- Relaxing smoky flames
- LED brightness control
- Thermostatic remote & manual control operation
- Includes wall fixing bracket



Atmospheric flame ascension

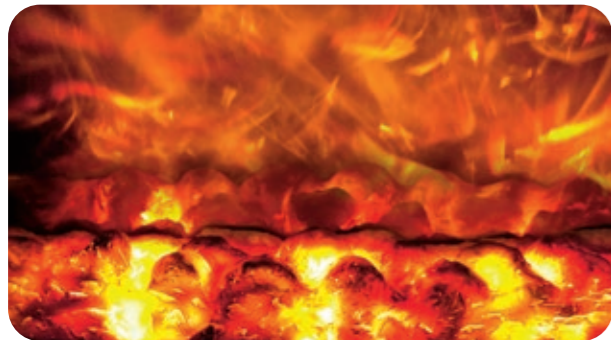

Specification

Dimensions: mm	H 600 x W 1100 x D 150
Heat Output	0.75kW – 1.5kW
Finish	 Prestige Brown
Natural Marble	



Video

EXO BLACK GLASS



Video

Electriflame XD Wall Mounted Fire

Black Glass 1300



Features

- Glass fronted fire
- High definition effect
- Extra deep 3D coals
- Relaxing smoky flames
- LED brightness control
- Thermostatic remote & manual control operation
- Includes wall fixing bracket
- Available in two sizes



Black Glass 1100



Specification

Dimensions: mm	H 600 x W 1300 & 1100 x D 126
Heat Output	0.75kW - 1.5kW

Finish



EXO ROYAL BOTTICINO



Video

Electriflame XD Wall Mounted Fire



Features

- Glass fronted fire
- High definition effect
- Extra deep 3D coals
- Relaxing smoky flames
- LED brightness control
- Thermostatic remote & manual control operation
- Includes wall fixing bracket



Specification

Dimensions: mm	H 600 x W 1100 x D 150
Heat Output	0.75kW - 1.5kW

Finish

Natural Marble



EXO TRAVERTINE

Electriflame XD Wall Mounted Fire



Video

Travertine 1100



Features

- Glass fronted fire
- High definition effect
- Extra deep 3D coals
- Relaxing smoky flames
- LED brightness control
- Thermostatic remote & manual control operation
- Includes wall fixing bracket
- Available in two sizes



Travertine 1300



Specification

Dimensions: mm	H 625 x W 1300 & 1100 x D 150
Heat Output	0.75kW - 1.5kW

Finish

Natural  Travertine

EXO PIANO BLACK

Electriflame XD Wall Mounted Fire



Video



Features

- Glass fronted fire
- High definition effect
- Extra deep 3D coals
- Relaxing smoky flames
- LED brightness control
- Thermostatic remote & manual control operation
- Includes wall fixing bracket



Specification

Dimensions: mm	H 600 x W 1300 x D 150
Heat Output	0.75kW - 1.5kW

Finish

Glossy Painted  Black



Video



Satin Champagne

Features

- Glass fronted fire
- Customisable fuel effect
- Silver birch logs
- Crystal ash embers
- Single or dual colour flame
- LED brightness control
- Thermostatic remote & manual control operation



Optional Extras

75mm Spacer frame
For flat wall installation



Satin Silver

Black Textured

Finishes

Anodised Aluminium Fascia
Brushed Metallic
Textured Black Paint

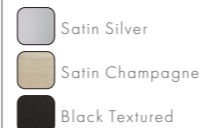

Specification

Dimensions: mm	H 619 x W 537 x D 105
Heat Output	0.75kW - 1.5kW



Video



Gold

Features

- Glass fronted fire
- Customisable fuel effect
- Silver birch logs
- Crystal ash embers
- Single or dual colour flame
- LED brightness control
- Thermostatic remote & manual control operation



Optional Extras

75mm Spacer frame
For flat wall installation



Chrome

Black Nickel

Finishes

High Quality Cast Iron Fascia
Metallic Plated

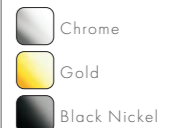

Specification

Dimensions: mm	H 630 x W 528.5 x D 122
Heat Output	0.75kW - 1.5kW



Video



Satin Silver

Features

- Glass fronted fire
- Customisable fuel effect
- Silver birch logs
- Crystal ash embers
- Single or dual colour flame
- LED brightness control
- Thermostatic remote & manual control operation



Optional Extras

75mm Spacer frame
For flat wall installation



Black

Specification

Dimensions: mm	H 610 x W 537 x D 105
Heat Output	0.75kW - 1.5kW

Finishes

Steel Fabricated Fascia
Brushed Metallic
or Smooth Black Paint



Video



Black & Chrome

Features

- Glass fronted fire
- Customisable fuel effect
- Silver birch logs
- Crystal ash embers
- Single or dual colour flame
- LED brightness control
- Thermostatic remote & manual control operation



Optional Extras

75mm Spacer frame
For flat wall installation



Black & Gold

Specification

Dimensions: mm	H 612 x W 528 x D 130
Heat Output	0.75kW - 1.5kW

Finishes

High Quality Cast Iron Fascia
Dual Metallic Plated

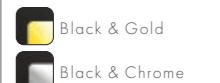

Black Nickel & Black



EX SIGNATURE

Electriflame XD Hearth Inset Fire

Features

- Glass fronted fire
- Customisable fuel effect
- Silver birch logs
- Crystal ash embers
- Single or dual colour flame
- LED brightness control
- Thermostatic remote & manual control operation



THERMO-STATIC



7 DAY TIMER



ENERGY SAVING



ISO FLAME



FLAME FUSION

Optional Extras

75mm Spacer frame
For flat wall installation



Satin Silver & Chrome



Video

Specification

Suite Dimensions: mm	H 599 x W 498 x D 129
Heat Output	0.75kW – 1.5kW
Finishes	<input checked="" type="checkbox"/> Black Nickel & Black <input type="checkbox"/> Satin Silver & Chrome
Steel Fabricated Fascia	
Dual Metallic	



Electriflame XD Hearth Inset Fire



Video



Satin Silver

Features

- Glass fronted fire
- Customisable fuel effect
- Silver birch logs
- Crystal ash embers
- Single or dual colour flame
- LED brightness control
- Thermostatic remote & manual control operation



Optional Extras

75mm Spacer frame
For flat wall installation



Brass

Black

Finishes

Steel Fabricated Trim
Solid Brass or Cast Iron Fret
Metallic or Smooth Black Paint

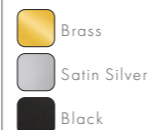

Specification

Dimensions: mm	H 595 x W 490 x D 100
Heat Output	0.75kW - 1.5kW



Electriflame XD Hearth Inset Fire



Video



Satin Silver

Features

- Glass fronted fire
- Customisable fuel effect
- Silver birch logs
- Crystal ash embers
- Single or dual colour flame
- LED brightness control
- Thermostatic remote & manual control operation



Optional Extras

75mm Spacer frame
For flat wall installation



Brass

Finishes

Quality Cast Trim and Fret
Solid Brass or Cast Iron
Black paint detail



Specification

Dimensions: mm	H 650 x W 535 x D 100
Heat Output	0.75kW - 1.5kW

Electriflame XD Hearth Inset Fire

Features

- Glass fronted fire
- Customisable fuel effect
- Silver birch logs
- Crystal ash embers
- Single or dual colour flame
- LED brightness control
- Thermostatic remote & manual control operation



Optional Extras

75mm Spacer frame
For flat wall installation



Brass

Chrome

Finishes

Steel Fabricated Trim
Solid Brass or Cast Iron Fret
Metallic or Smooth Black Paint

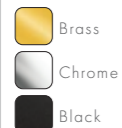

Black

Specification

Dimensions: mm	H 595 x W 490 x D 100
Heat Output	0.75kW - 1.5kW



Video

Metal 2



EXD METAL 1 & 2

Electr stove XD Stove

Features

- Tough steel body & door
- High definition effect
- Extra deep 3D coals
- Relaxing smoky flames
- LED brightness control
- Thermostatic remote & manual control operation



THERMO-STATIC



8 HOUR TIMER



ENERGY SAVING



ISO FLAME



Metal 1



METAL 1 Video



METAL 2 Video

Specification

Dimensions: mm	Metal 1 Metal 2	H 579 x W 430 x D 332 H 587 x W 524 x D 295
Heat Output		1.0kW - 2.0kW
Finish	Steel Fabricated Body	 Black

Optional Extras

- Woodland logs fuel effect
- Decorative Steel Flue Pipe Accessories

EXO GLASS 1 & 2

Electr stove XD Stove

Features

- Tough steel body
- Glass door & stove top
- High definition effect
- Extra deep 3D coals
- Relaxing smoky flames
- LED brightness control
- Thermostatic remote & manual control operation



Glass 2



GLASS 2
Video



Glass 1

Specification

Dimensions: mm	Glass 1 Glass 2	H 583 x W 430 x D 334 H 591 x W 524 x D 295
Heat Output		1.0kW – 2.0kW
Finish	Steel Fabricated Body Glass Door	Black Glass & Chrome



GLASS 1
Video

FMK RAPTURE

Flamonik Wall Mounted Fire



Video



Features

- Flat glass fascia
- Distinctive flame effect
- Raised log fuel bed
- Thermostatic remote & manual control operation
- Includes wall fixing bracket



Magenta



Blue



Amber



Specification

Dimensions: mm	H 440 x W 686 x D 110
Heat Output	0.75kW - 1.5kW

Finish



Black Glass

FMK ENCHANT

Flamonik Wall Mounted Fire



Video



Features

- Curved glass fascia
- Enchanting smoky flame effect
- Raised log fuel bed
- Thermostatic remote & manual control operation
- Includes wall fixing bracket



Magenta



Blue



Amber



Specification

Dimensions: mm	H 441 x W 916 x D 126
Heat Output	0.75kW - 1.5kW

Finish



Black Glass

ACCENT TRADITIONAL

Hearth Inset Fire



Video



Features

- Open fire experience
- Lively ribbon flame effect
- Coal effect fuel bed
- LED brightness control
- Thermostatic remote & manual control operation



Chrome

Finishes

Steel Fabricated
Metallic Plated Trim

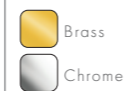

Specification

Dimensions: mm	H 595 x W 490 x D 35
Heat Output	1.0kW - 2.0kW

ACCENT INFUSION

Hearth Inset Fire



Video



Features

- Open fire experience
- Lively ribbon flame effect
- Coal effect fuel bed
- LED brightness control
- Thermostatic remote & manual control operation



Brass & Black



Black & Chrome

Finishes

Steel Fabricated Fascia
Dual Metallic & Painted

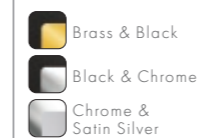

Specification

Dimensions: mm	H 595 x W 498 x D 83
Heat Output	1.0kW - 2.0kW

ULTIFLAME® VR

Firebeam Suites 6-13

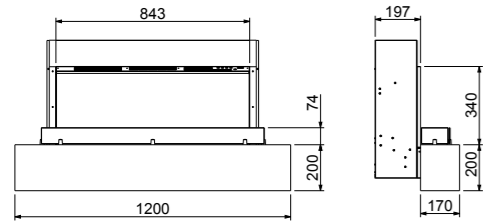

FIREBEAM 800 ILLUMIA

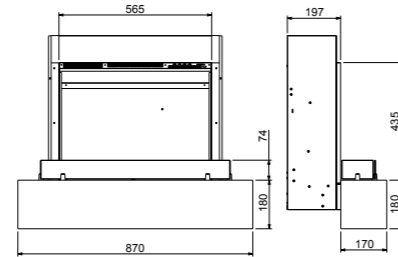

FIREBEAM 600 ILLUMIA

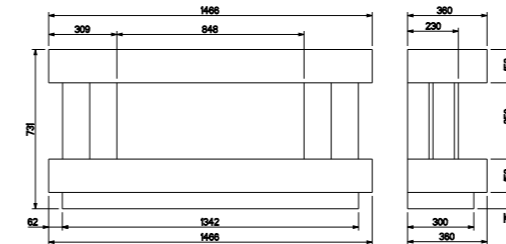

GEMMA 800 ILLUMIA

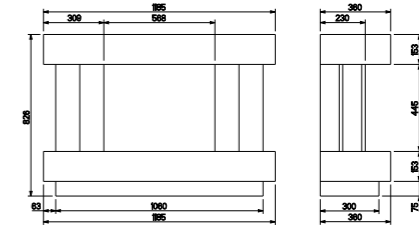

GEMMA 600 ILLUMIA

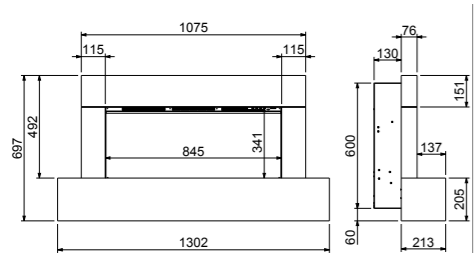

FIREBEAM XL800 ILLUMIA

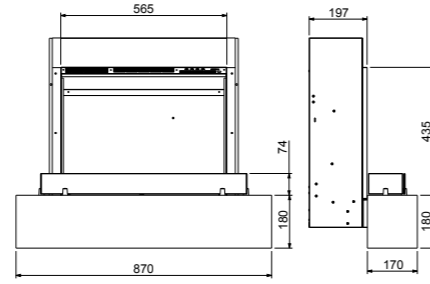

FIREBEAM XL600 ILLUMIA

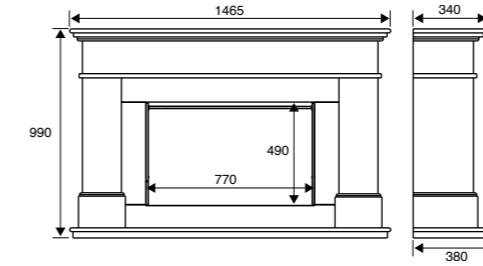

ADOUR ALEESIA ILLUMIA

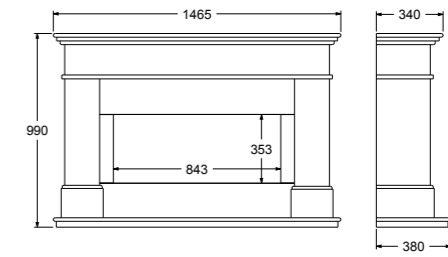

ADOUR ELITE ILLUMIA

Freestanding Suites 14-31

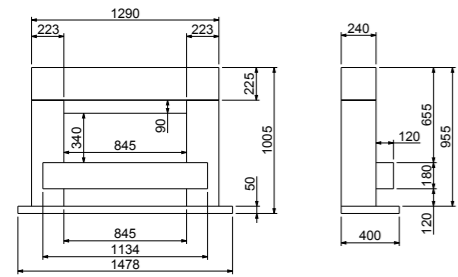

LUMINAIRE 800 ILLUMIA

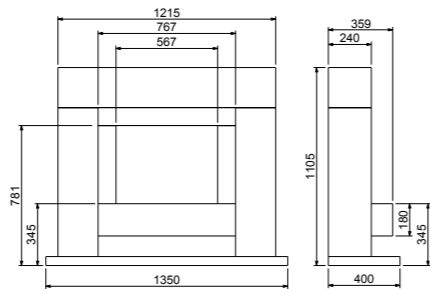

LUMINAIRE 600 ILLUMIA

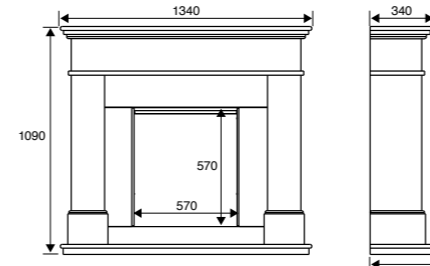

ADOUR ASENCIO ILLUMIA

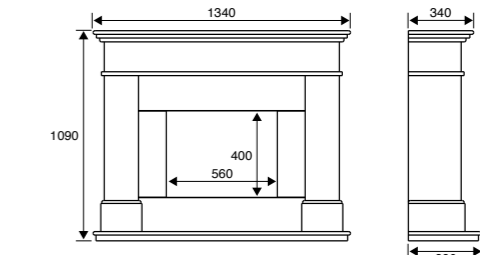

ADOUR ILLUMIA



SKYFALL 800 ILLUMIA

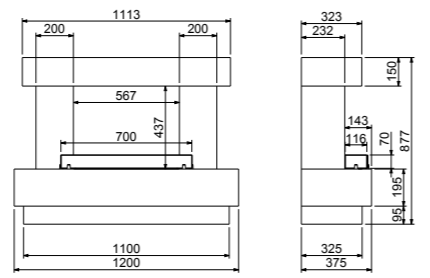

SKYFALL 600 ILLUMIA

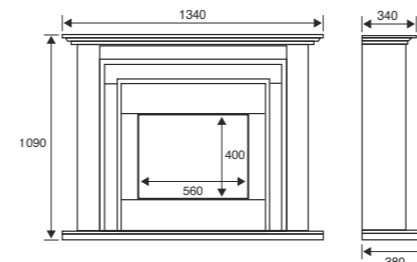

CANELO ILLUMIA

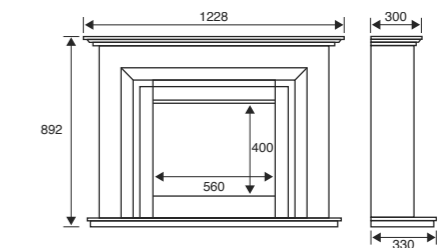

ELARA

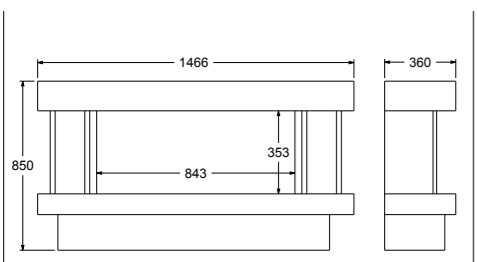

ORBITAL 800 ILLUMIA

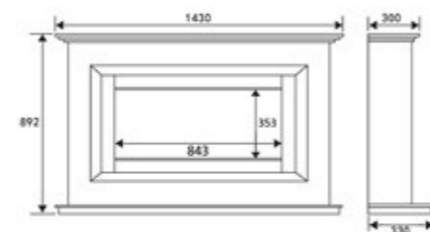

VEGA

ULTIFLAME® VR

Inset Limestone Suites 32-38

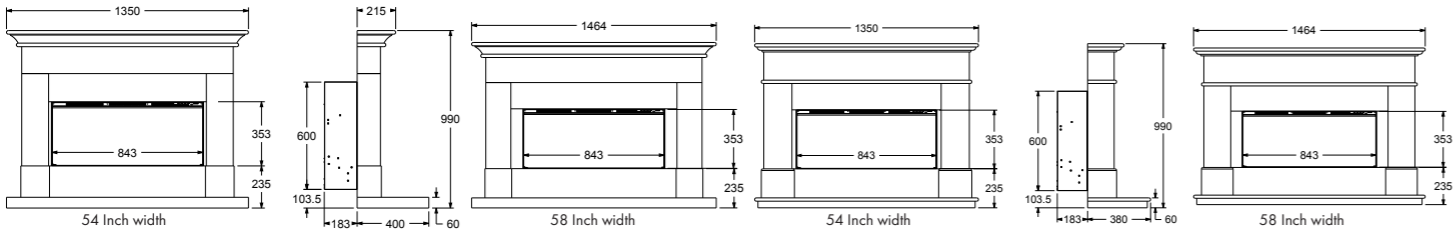

PARADA ELITE ILLUMIA

AVIGNON ELITE

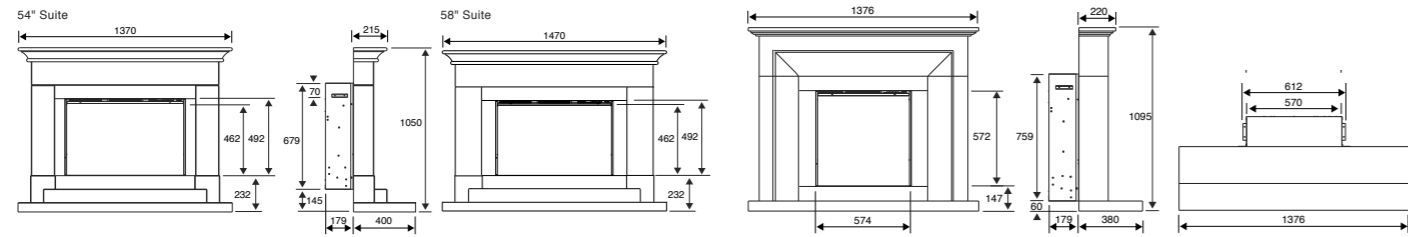

ALEESIA ILLUMIA

AENCIO

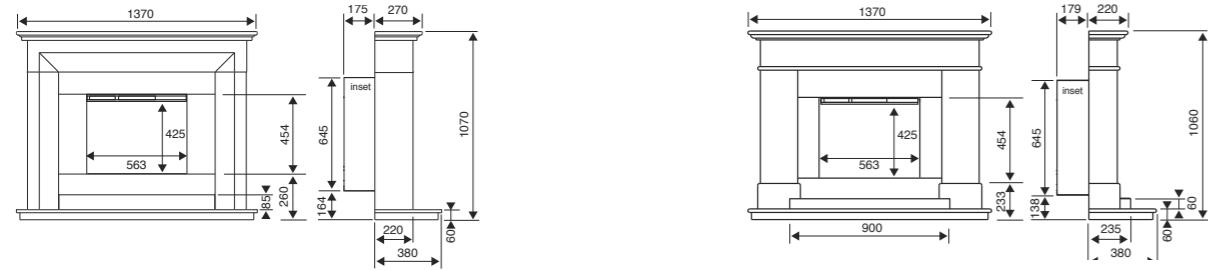

ANGELO

BOTICELLI

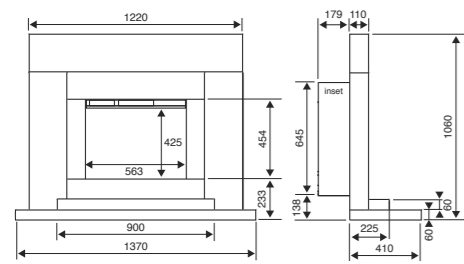

PABLO

Wall Inset 39-47

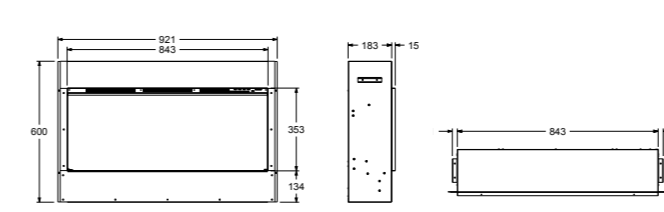

ELITE

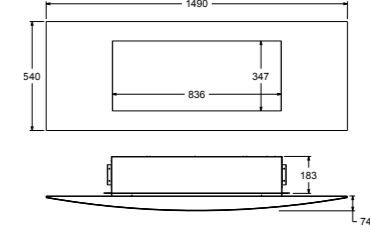

VICHY

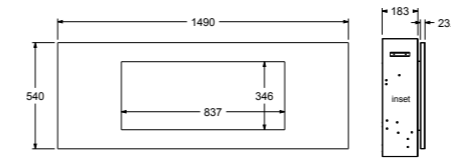

METZ

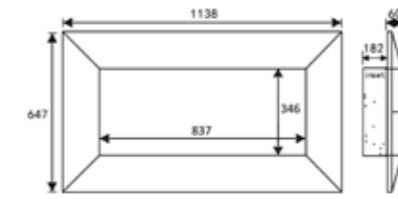

INSTINCT

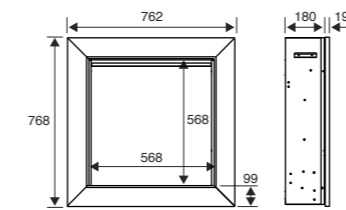

EVORA AENCIO

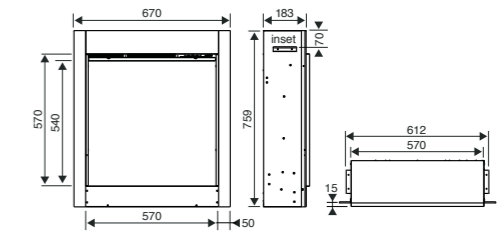

AENCIO

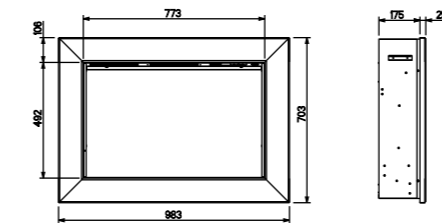

VADER ALEESIA

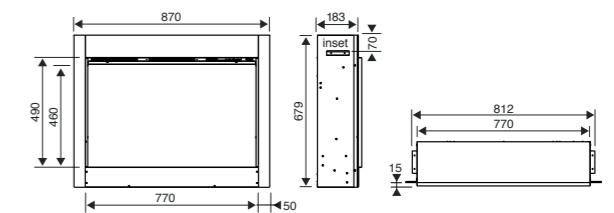

ALEESIA

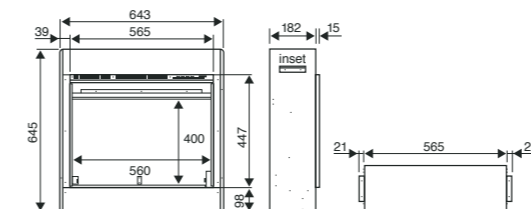

CELENA

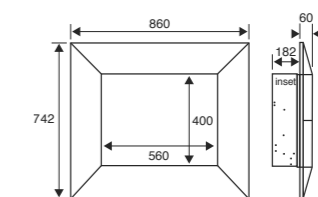

IMPULSE

ULTIFLAME® VR

Hearth Inset Fires 48-55

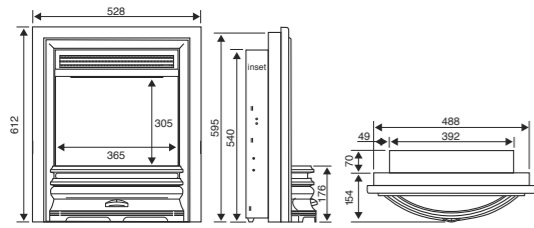

ARCADIA

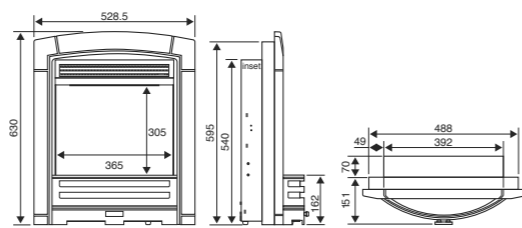

DECADENCE

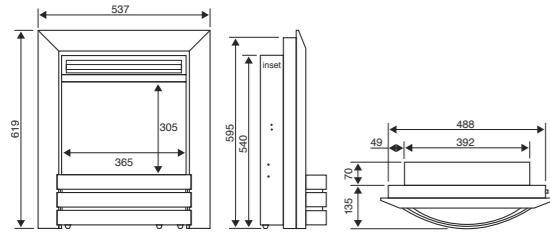

CAMBER

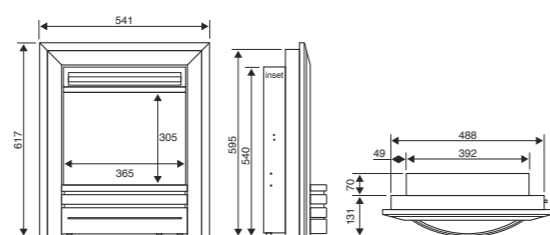

FRONTIER

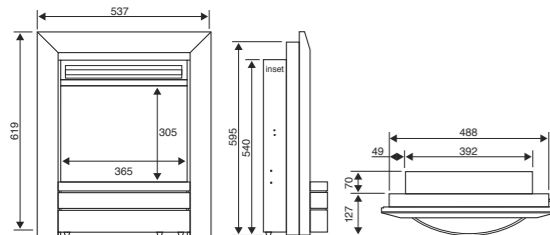

ESSENCE

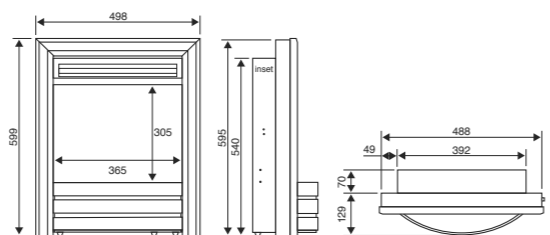

DESIGNER

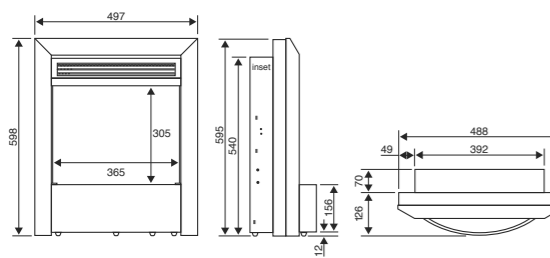

ENDURA

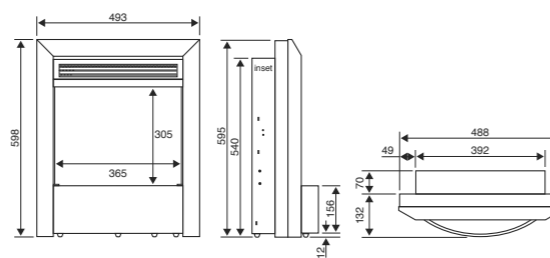

CONTEMPORARY

ELECTRIFLAME® VR

Freestanding Suites 56-63

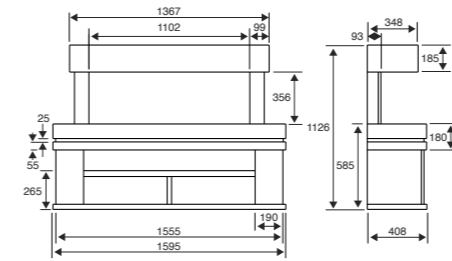

MEDIA 1100 ILLUMIA

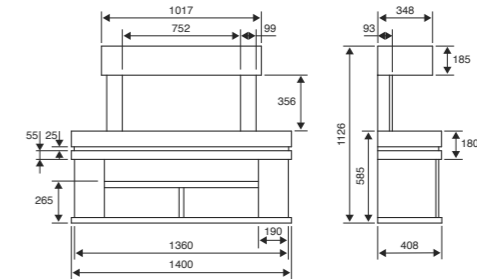

MEDIA 750 ILLUMIA

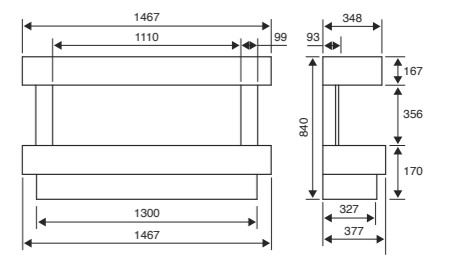

CARINO 1100 ILLUMIA

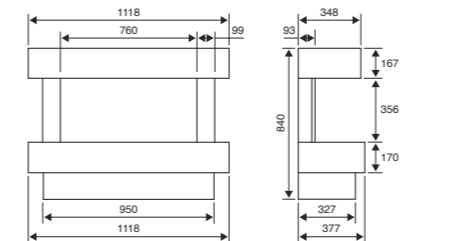

CARINO 750 ILLUMIA

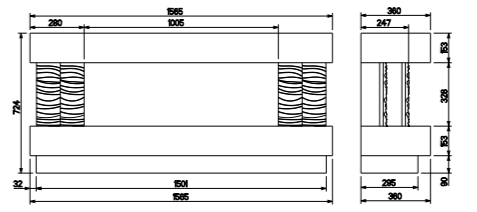

GEMMA 1000 ILLUMIA

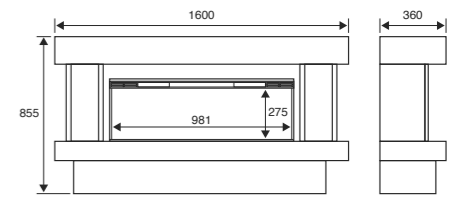

ORBITAL 1000 ILLUMIA

Wall Mounted Suites 64-66

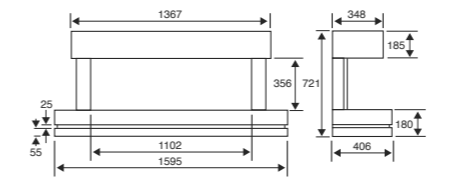

VOLARE 1100 ILLUMIA

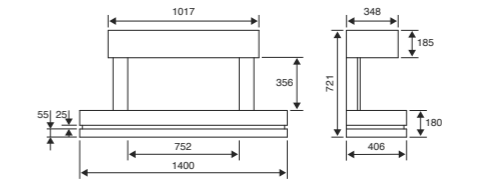

VOLARE 750 ILLUMIA

Built-In 3 Sided Glass Fires 67-77

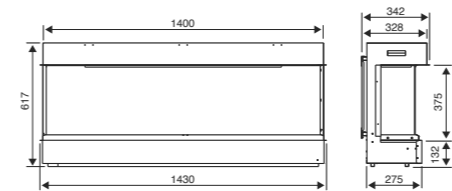

1400

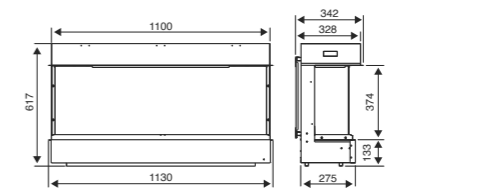

1100

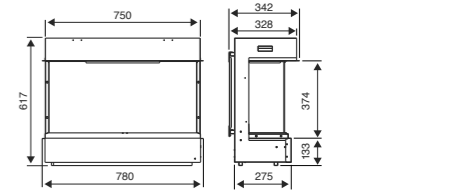

750

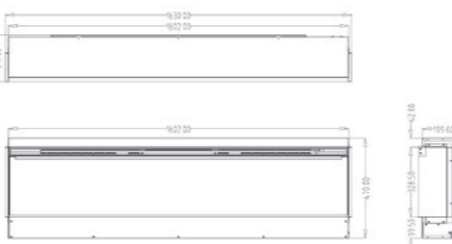

COMMODUS s1600

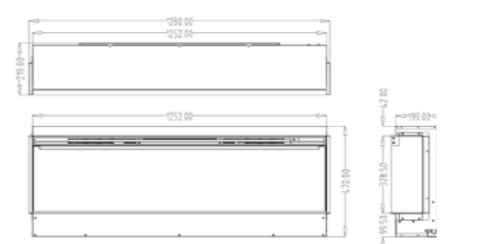

COMMODUS s1250



COMMODUS s1000

ELECTRIFLAME® VR

Wall Inset Fires 78-79

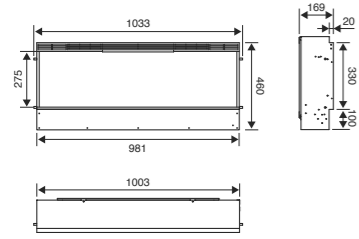

COMMODUS

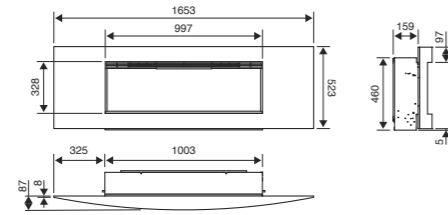

VICHY

Wall Mounted Fires 80-81

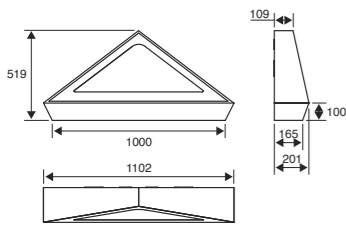

LOUVRE

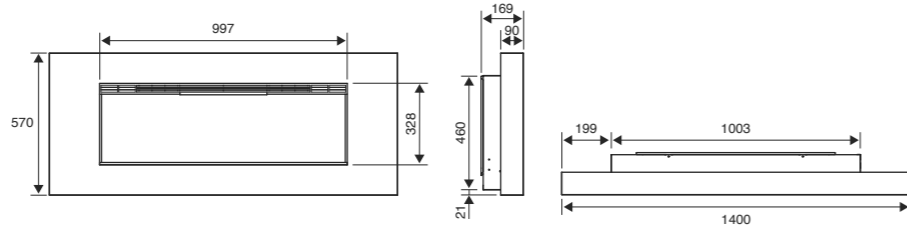

BASILICA

Hearth Inset Fires 82-85

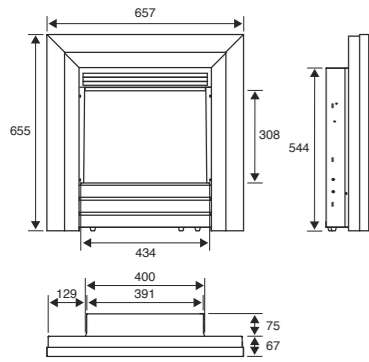

ACERO

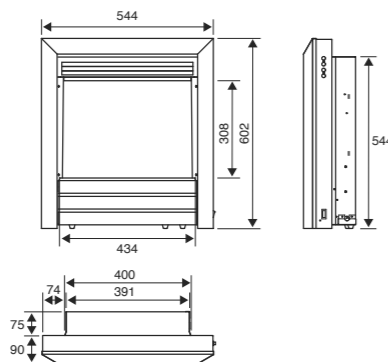

PARRILLA

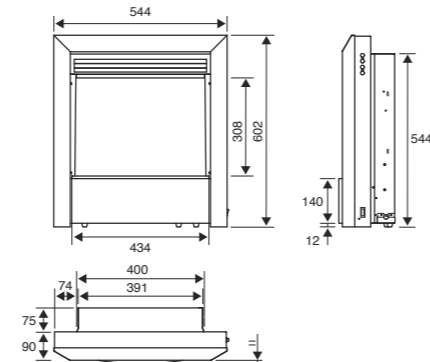

CONTEMPORARY

ELECTRISTOVE® VR

Stoves 86-89

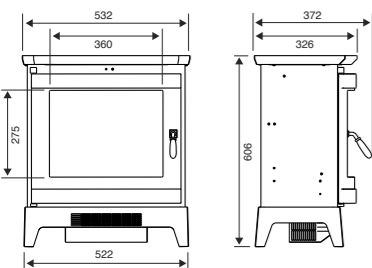

ROCHESTER

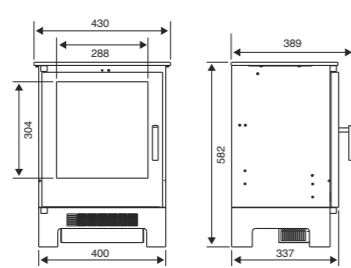

ARUNDEL

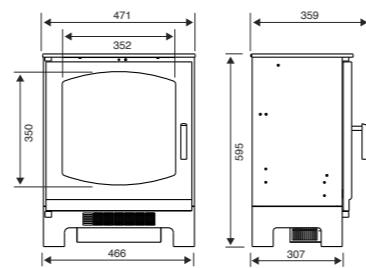

LUXIMA

ELECTRIFLAME® XD

Wall Mounted Fires 90-95

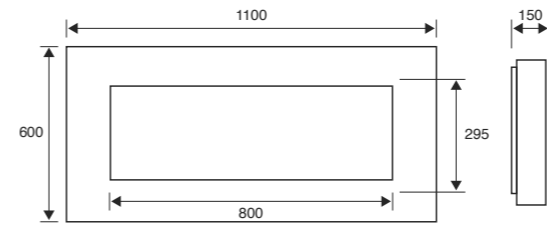

PRESTIGE

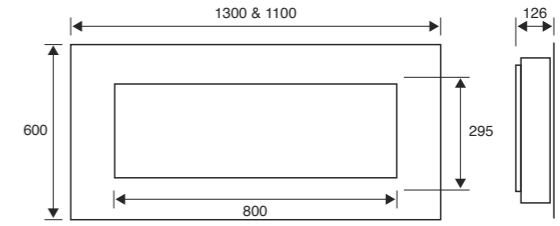

BLACK GLASS

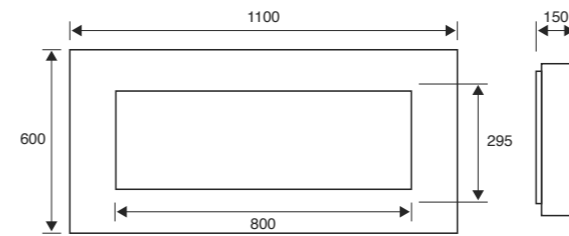

ROYAL BOTTICINO

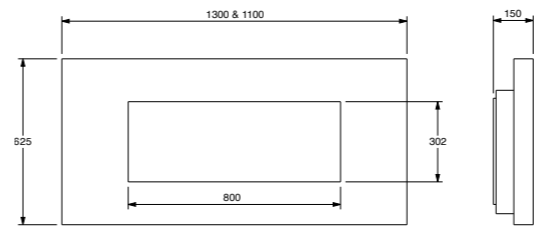

TRAVERTINE

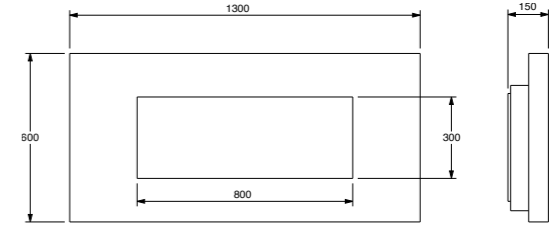

PIANO BLACK

ELECTRIFLAME® XD

Hearth Inset Fires 96-105

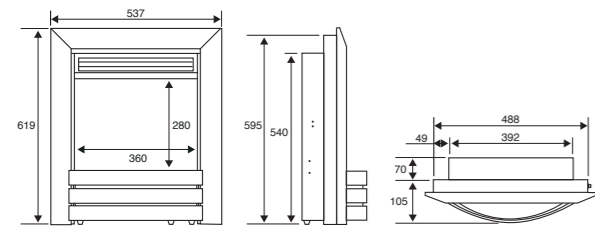

CAMBER

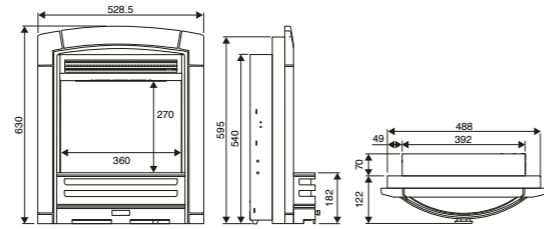

DECADENCE

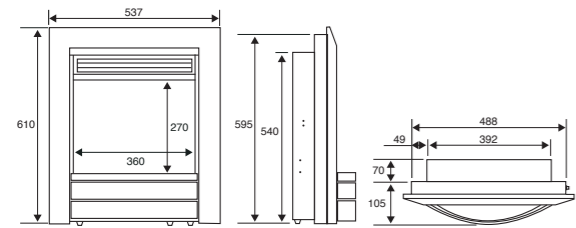

ESSENCE

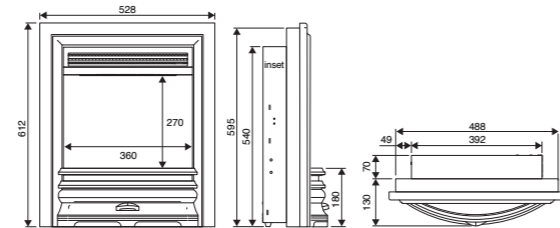

ARCADIA

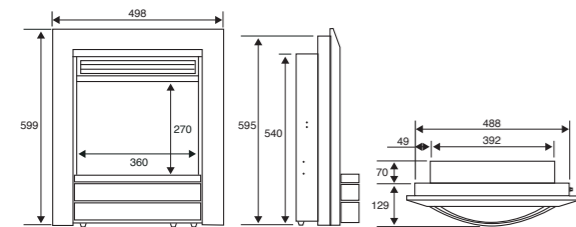

SIGNATURE

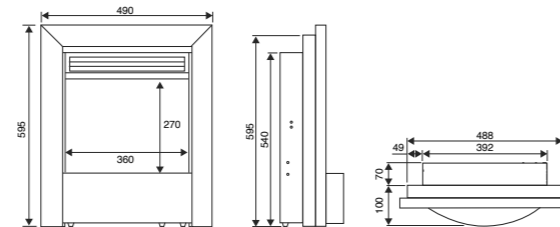

DAISY

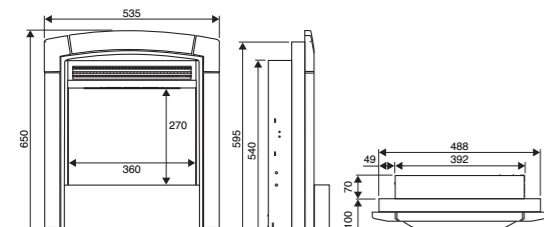

CARESS

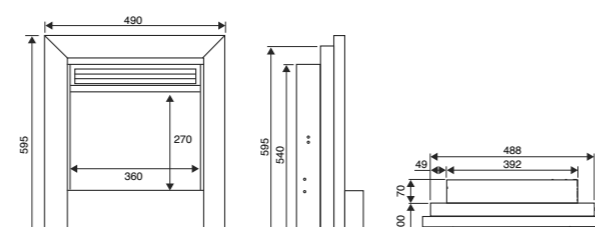

BAUHAUS

ELECTRISTOVE® XD

Stoves 106-109

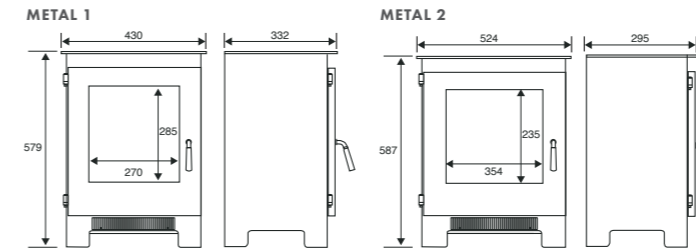

ELECTRISTOVE METAL

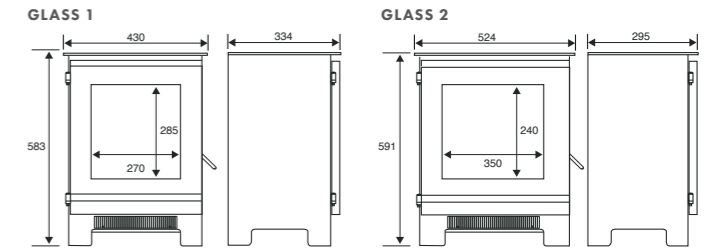

ELECTRISTOVE GLASS

FLAMONIK

Wall Outset - 110-111

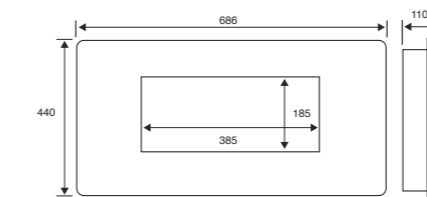

RAPTURE

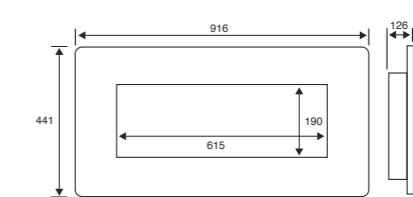

ENCHANT

ACCENT

Hearth Inset - 112-113

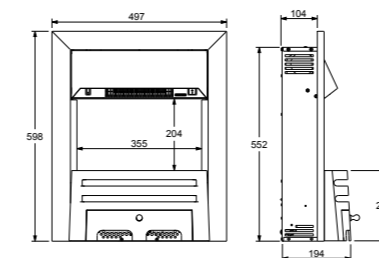

ACCENT TRADITIONAL

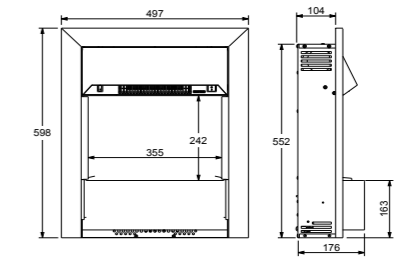

ACCENT INFUSION



DISCLAIMER

Our policy is one of constant development and improvement. We therefore reserve the right to revise designs and specifications of our products without formal notice, patents pending. We always recommend our products be viewed in an approved showroom before purchase. Whilst we have taken every care in the preparation of this brochure it is not intended to replace the installation manual which provides more detailed information.

Photography is for illustration purposes only and although every effort has been made to ensure accurate reproduction of typical installations and flame pictures they may vary according to fire model and flue types.

We accept no liability for any loss or damage arising directly or indirectly from the use of this brochure.

We recommend that all our fires are used in conjunction with central heating and not as a primary source of heat.

In the interests of personal safety a suitable fireguard is recommended when children, the elderly and the infirm are present.

This brochure is copyright 2022/23 and must not be reproduced in whole or in any part without prior written permission.



BFM Europe Ltd, Gordon Banks Drive,
Trentham Lakes, Stoke-on-Trent ST4 4TJ

Tel: 01782 339000

Email: sales@bfm-europe.com

www.celsielectricfires.co.uk

Go direct to the Celsi website on your smart phone or tablet device and use the app to scan the black and white QR codes shown on each page. Alternatively, go to www.celsielectricfires.co.uk to browse all Celsi electric fires.

