

Global fires

GAS FIRES 2022



MADE IN BRITAIN





Welcome to Global

At Global Fires we know how important it is to create a stylish and relaxing living environment. That's why we've developed this collection of versatile and affordable gas fires to complement all tastes and lifestyles.



I believe our success stems from a combination of innovative design, investment in technology and the highest quality manufacturing standards. As a result all Global fires carry a 10 year guarantee to reflect my belief in their quality and durability, and our experienced Global retailers are hand-picked to give you the very best advice and service.

This brochure has been designed to make the purchase of your new Global fire as simple as possible. I hope you will find it both informative and inspiring.



Today BFM Europe is the fastest growing domestic fire producer in the country with an unequalled reputation for quality and services. Every Global branded gas fire is designed and developed in our ultramodern purpose built, British manufacturing facility in Stoke-on-Trent.



10 Year Guarantee

All Global gas fires carry the peace of mind of a 10 year Guarantee and the reassurance of a flame supervision device on all models. This device prevents the uncontrolled release of gas to the burner.

Our 10 year Guarantee is subject to terms and conditions including annual services and annual replacement of the oxy-pilot assembly carried out by a Gas Safe Register engineer.



Product Testing & Certification

All our gas fires are independently tested, approved and verified by the British Standards Institution (BSI) to meet the latest standards for performance, safety and efficiency.

The BSI is an independent organisation. They are not owned by the government, industry or shareholders, which means that they can be totally objective with regards testing and certification. This gives their assessments more authority than those of an organization that has a vested interest in promoting its members.

They have some of the most experienced and knowledgeable staff in the world and are recognised internationally for their technical expertise, quality services and in-depth knowledge of gas and electrical product testing and certification.

The wide-ranging capability of their testing facilities and the broad expertise and knowledge of their testing and certification staff ensures our products are rigorously tested with the utmost integrity.



Ecodesign compliant

This logo signifies that the product is fully compliant with the Eco design directive Commission Regulation (EU) 2015/1188.

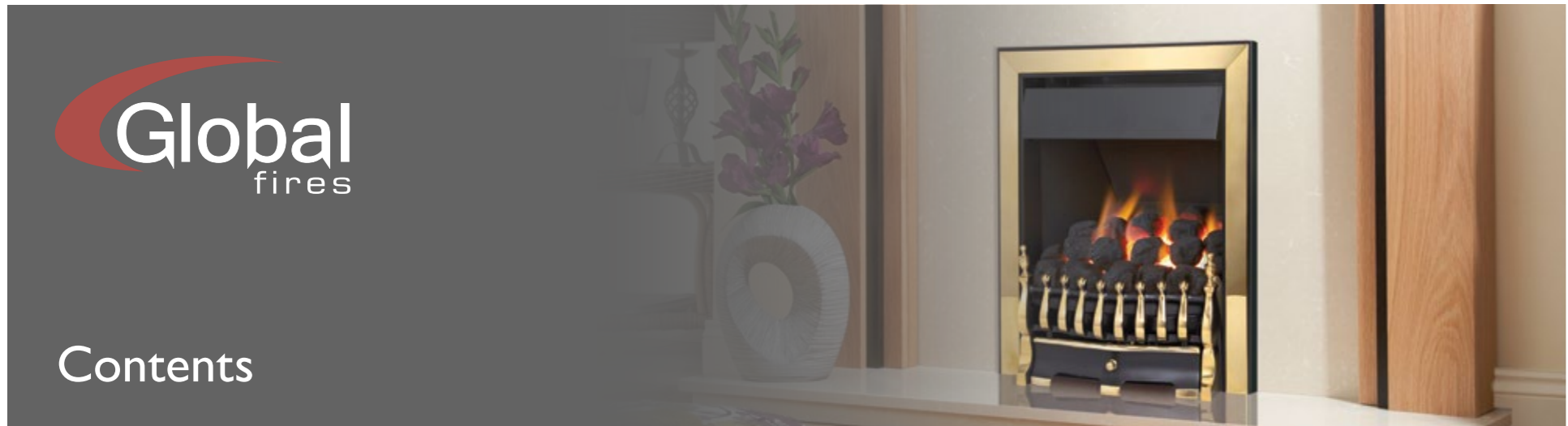

Using this brochure

Before you begin please take a moment to read page 6 and establish the type of chimney or flue you have in your home and the control type which would be most suitable for your needs. As you browse through our product range you can easily identify if a gas fire is suitable for you by checking the icons on each page.

Unless otherwise stated, our hearth inset fires come complete with a Profiled trim in your choice of brass, chrome, satin silver or black finish. Complete the look of your chosen fire with any of our traditional or contemporary fret designs. You may also be able to upgrade to a different trim, or for a more modern look, one of our fascia options. See pages 20-22 to find out which accessories are suitable for your chosen fire.

Welcome to Global.....	2-3
Contents.....	4
Efficiencies.....	5
Before you begin.....	6

high efficiency

Conventional Flue

Wall Inset – Glass Fronted

Delta HE.....	7
---------------	---

Hearth Inset – Glass Fronted

Saranda HE.....	8
Karara HE.....	9
Fantasy HE.....	10

Hearth Inset – Open Fronted

Fantasy Plus.....	11
Arana Plus.....	12
Corda Plus.....	13
Arana.....	14

Balanced Flue

Hearth Inset – Glass Fronted

Fantasy BF.....	15
Corda BF.....	16

standardfires

Conventional Flue

Hearth Inset – Open Fronted

Corda.....	17
Karara.....	18
Fantasy.....	19

Accessories

Trims.....	20
Frets.....	21
Fascias.....	22

high efficiency

Get up to 93.5% energy efficiency from your gas fire...

Global Fires have set new industry standards with the introduction of the high efficiency range: exceptional heat output combined with lower running costs compared to standard gas fires.

Our team has invested in developing the technology to meet the key objective of producing gas fires that save energy and as a result, help to keep costs down.

Conventional Flue Fires

Balanced Flue Fires

Glass Fronted Fires



Open Fronted Fires



Glass Fronted Fires



Our range of high efficiency conventional flue fires have an energy efficiency of up to 86%. These types of fires have a glass panel across the front which concentrates the radiant heat generated from the fuel bed, and forces it directly into the room with less heat lost through the chimney. Convected heat is also produced by cool air drawn into the base of the fire through the heat exchanger and then emitted as warm air through the gap above the canopy, making these the most efficient conventional flue fires available.

Our high efficiency conventional flue open fronted fires can reach an energy efficiency of up to 68.3%. These fires provide the look and feel of a real open fire providing both radiant and convected heat. Radiant heat is emitted from the fuel bed and the convected heat is generated by cool air drawn into the base of the fire which passes through a heat exchanger and is then emitted as warm air through the gap above the canopy.

Our range of high efficiency balanced flue fires have an energy efficiency of up to 93.5%. Designed for those who want all the benefits of a gas fire but don't have a built in chimney or flue in their home. A balanced flue fire comes with its own flue terminal which is vented directly through an outside wall. These types of fires are glass fronted, completely room sealed appliances, and work by drawing and venting external air via a pair of co-axial tubes into the fire for combustion purposes.

standardfires

Conventional Flue Fires

Open Fronted Fires



Standard fires can achieve a direct heat output of up to 3.1kW. It is recommended that these products are not suitable for use as a primary heat source, but are ideal if you are looking for a great fireplace feature for occasional use.

Before you begin...

Type of Chimney or Flue

The type of chimney or flue you have dictates the type of fire you can have. But if you're not sure, then take a look at your roof and compare it with the simple guide below. It's worth remembering that a full depth fire often requires a traditional chimney or rebate on the fire surround, whilst a slimline fire will fit virtually any chimney or flue.



Brick Chimney

Apart from products designed for 'no chimney' applications, all Global products will fit brick chimneys. They are easily recognisable by a chimney stack with accompanying terracotta pot or gas terminal.



Pre-Fabricated Flue

Pre-fabricated flues are easily identifiable by a metal flue and terminal on the roof and a metal flue box behind the fire.

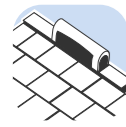

Pre-Cast Flue

Pre-cast flues can be identified by a ridge vent or metal flue tube and terminal on the roof. Constructed from concrete or clay blocks they form a rectangular section flue. All Global fires featuring this icon are only suitable for pre-cast flues conforming to BS EN 1858.

Can't see a Chimney or Flue?

If you can't see a chimney or flue like the ones described above, then you will require a Balanced Flue fire.



Balanced Flue

Balanced Flue fires use a horizontal pipe to vent directly outside. An electricity supply is not required for Balanced Flue products.

Controls



Manual Control

Simple and discreet. The control system is located behind the fire's fret or trim. Once the fire is lit rotate the control knob to adjust the flame height and heat output.



Slide Control

A convenient control system which is located on the top right-hand side of the fire. Push and hold the lever down to ignite and move it up and down to adjust the flame height and heat output.



Easy Flame Control (EFC)

Discreet, easy access buttons are used to ignite the fire and adjust heat and flame height.



Remote Control

The remote control handset is used to light the fire as well as to adjust the flame height and heat output.



Remote Control with Thermostat

The remote control handset can be used to light the fire as well as to adjust the flame height and heat output. In addition, the handset contains the extra benefit of a thermostatic control to regulate room temperature and a programmable timer that can be pre-programmed to ensure your room will be warm whenever you wish.

Fuel Bed Effects



Coal



Pebble



Log

Back Panels



Plain Black



Brick Effect

Gas Supply

All our products are designed to run on Natural Gas.



Natural Gas

If you have a gas meter then you will have natural gas.



Delta HE Wall Inset coal

Delta HE Wall Inset *pebble



Natural Gas

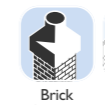

Brick Chimney

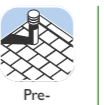

Pre-Fabricated

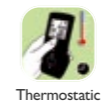

Thermostatic Remote

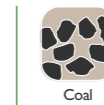

Coal



Pebble



Plain Black

*Optional extra

high efficiency Conventional Flue

Wall Inset – Glass Fronted

Delta HE



This portrait hole-in-the-wall fire features a striking chrome fascia and a 3.4kW heat output. The Delta HE wall inset is the ideal solution for smaller rooms where space is at a premium. The glass fronted Delta HE is operated by thermostatic remote control and comes with a coal fuel bed.

Specifications

Description: Mid depth inset gas fire
Type of Heat: Radiant & Convected

Useful energy efficiency	84.3%
Energy efficiency class	C
Fuel type	Natural gas
Direct heat output	3.4kW

Fuel effect	Control type	Model Number
Coal	Remote	GHKC56RN3

Safety: Flame Supervision Device & Oxygen Depletion Sensor
Air vent required: Not normally

Dimensions

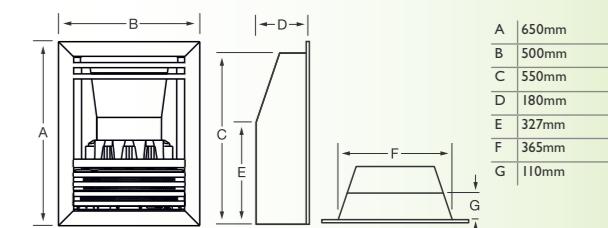

high efficiency Conventional Flue

Hearth Inset – Glass Fronted

Saranda HE



If you're looking for a gas fire with efficiency in mind this has to be the product for you. The Saranda HE glass fronted fire features our most realistic full depth coal effect fuel bed and boasts an energy efficiency of 86%. With an impressive 3.9kW output the Saranda HE keeps your heat high and your fuel costs low.

Full range of trims, frets and fascias available. See pages 20-22

Specifications

Description: Full depth inset gas fire
Type of Heat: Radiant & Convected

Useful energy efficiency	86%
Energy efficiency class	C
Fuel type	Natural gas
Direct heat output	3.9kW

Fuel effect	Control type	Model Number
Coal	Manual	GHEC00MN
	Slide	GHEC00SN
	Remote	GHEC00RN2

Safety: Flame Supervision Device & Oxygen Depletion Sensor
Air vent required: Not normally

Dimensions

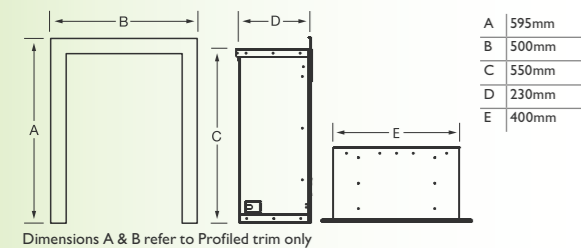

Saranda HE, Arcadia fascia in black & gold

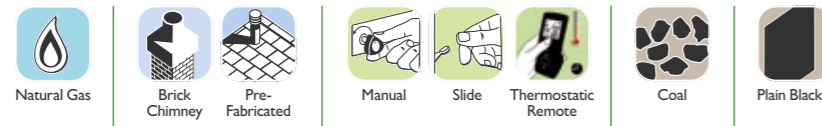

Karara HE coal, Contemporary fascia in satin silver

Karara HE *pebble
Manual control only
Contemporary fascia in chrome

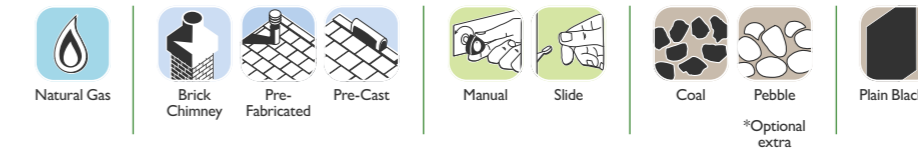

high efficiency Conventional Flue

Hearth Inset – Glass Fronted

Karara HE



The slimline Karara HE is the high energy efficiency solution for almost any flue type. Suitable for brick chimney, pre-fabricated and pre-cast flues, this glass fronted product delivers an amazing 2.9kW heat output and has an energy efficiency of 81.3%.

Full range of trims, frets and fascias available. See pages 20-22

Specifications

Description: Slimline inset gas fire
Type of Heat: Radiant & Convected

Useful energy efficiency	81.3%
Energy efficiency class	D
Fuel type	Natural gas
Direct heat output	2.9kW

Fuel effect	Control type	Model Number
Coal	Manual	GSHC00MN
	Slide	GSHC00SN2

Safety: Flame Supervision Device & Oxygen Depletion Sensor
Air vent required: Not normally

Dimensions

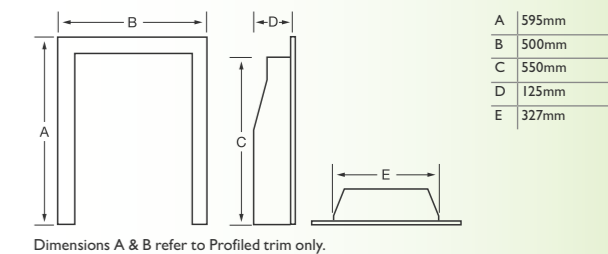

high efficiency Conventional Flue

Hearth Inset – Glass Fronted

Fantasy HE



The Fantasy HE features a highly realistic full depth fuel bed and will fit most chimney and flue applications, including pre-cast when fitted with a 3" rebated surround. This glass fronted fire provides an impressive 3.4kW heat output and 84.3% energy efficiency. With a coal fuel effect and manual, slide or thermostatic remote control, you will certainly find a model to suit your taste and needs.

Full range of trims, frets and fascias available. See pages 20-22

Specifications

Description: Mid depth inset gas fire
Type of Heat: Radiant & Convected

	Manual/Slide	Remote
Useful energy efficiency	84.3%	84.3%
Energy efficiency class	D	C
Fuel type	Natural gas	Natural gas
Direct heat output	3.4kW	3.4kW

Fuel effect	Control type	Model Number
Coal/Pebble	Manual	GHKC00MN2
	Slide	GHKC00SN2
	Remote	GHKC00RN3

Safety: Flame Supervision Device & Oxygen Depletion Sensor
Air vent required: Not normally

Dimensions

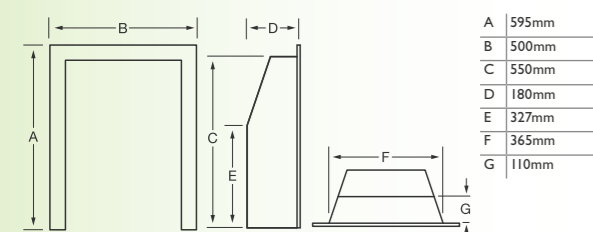

Dimensions A & B refer to Profiled trim only.



Fantasy HE *pebble
Dalliance fascia in chrome

Fantasy HE coal with Dalliance fascia in chrome

Natural Gas
 Brick Chimney
 Pre-Fabricated
 Pre-Cast
 Manual
 Slide
 Thermostatic Remote
 Coal
 Pebble
 Plain Black

*Optional extra

high efficiency Conventional Flue

Hearth Inset – Open Fronted

Fantasy Plus



The Fantasy Plus boasting an amazing 68.3% energy efficiency can be installed in to almost any chimney or flue, including pre-cast when fitted with a 3" rebated fire surround. This open-fronted gas fire features a highly realistic coal fuel effect and is available in manual, slide or remote control.

Full range of trims, frets and fascias available. See pages 20-22

Specifications

Description: Mid depth inset gas fire
Type of Heat: Radiant & Convected

Useful energy efficiency	68.3%
Energy efficiency class	F
Fuel type	Natural gas
Direct heat output	4.2kW

Fuel effect	Control type	Model Number
Coal/Pebble	Manual	GKPC00MN
	Slide	GKPC00SN
	Remote	GKPC00RN2

Safety: Flame Supervision Device & Oxygen Depletion Sensor
Air vent required: Not normally

Dimensions

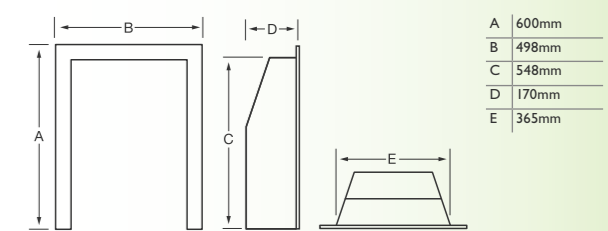

Dimensions A & B refer to Profiled trim only.



Fantasy Plus *pebble, Signature trim, Grace fret in satin silver & chrome

Fantasy Plus coal, Signature fascia in satin silver & chrome

Natural Gas
 Brick Chimney
 Pre-Fabricated
 Pre-Cast
 Manual
 Slide
 Remote
 Coal
 Pebble
 Plain Black

*Optional extra

high efficiency Conventional Flue

Hearth Inset – Open Fronted

Arana Plus



The Arana Plus is our first full depth open-fronted high efficiency gas fire. You can now achieve the look of a real open coal fire at an incredible 66.7% energy efficiency. Suitable for installation into standard chimneys the Arana Plus comes in a choice of manual, slide or remote control and can be styled with our wide choice of accessories.

Full range of trims, frets and fascias available. See pages 20-22

Specifications

Description: Full depth inset gas fire
Type of Heat: Radiant & Convected

Useful energy efficiency	66.7%
Energy efficiency class	F
Fuel type	Natural gas
Direct heat output	4.1kW

Fuel effect	Control type	Model Number
Coal	Manual	GOPC00MN
	Slide	GOPC00SN
	Remote	GOPC00RN2

Safety: Flame Supervision Device & Oxygen Depletion Sensor
Air vent required: Not normally

Dimensions

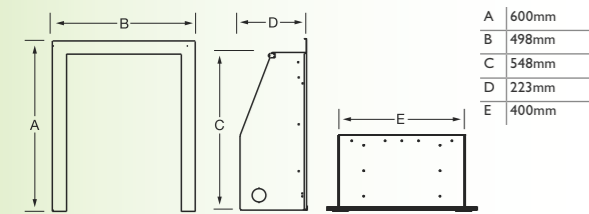

Dimensions A & B refer to Profiled trim only



Arana Plus, Signature trim in brass & black, Blenheim fret in antique brass

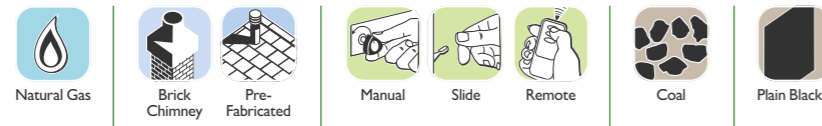

Corda Plus coal, Deluxe Contemporary fascia in satin silver

Corda Plus *pebble, Deluxe Contemporary fascia in satin silver

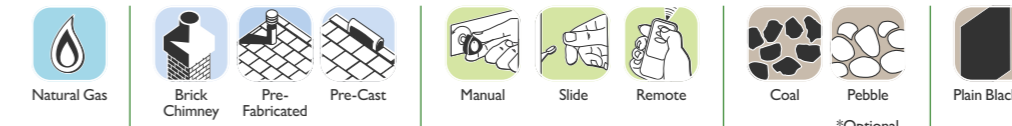

high efficiency Conventional Flue

Hearth Inset – Open Fronted

Corda Plus



The Corda Plus is one of the most efficient open-fronted slimline gas fires available today and with a heat output of up to 4kW it is also one of the warmest products suitable for a pre-cast flue.

The Corda Plus is available in a choice of manual, slide, or remote control. This extremely versatile fire can be styled with a wide range of Global accessories.

Full range of trims, frets and fascias available. See pages 20-22

Specifications

Description: Slimline inset gas fire
Type of Heat: Radiant & Convected

	Manual	Remote
Useful energy efficiency	66.8%	66.8%
Energy efficiency class	F	F
Fuel type	Natural gas	Natural gas
Direct heat output	4.0kW	3.8kW

Fuel effect	Control type	Model Number
Coal/Pebble	Manual	GSPC00MN
	Slide	GSPC00SN
	Remote	GSPC00RN2

Safety: Flame Supervision Device & Oxygen Depletion Sensor
Air vent required: Not normally

Dimensions

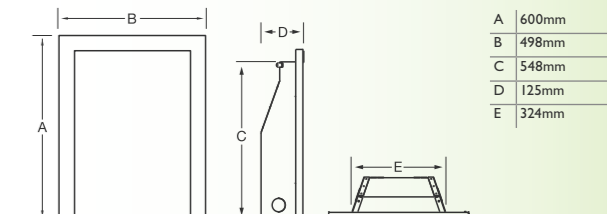

Dimensions A & B refer to Standard trim only

high efficiency Conventional Flue

Hearth Inset – Open Fronted

Arana



The Arana features one of the most realistic coal effects on the market and offers an amazing 3.7kW of heat. This open fronted fire is able to deliver a higher output through the use of a heat exchanger which draws in the cool room air and converts it to warm convected air.

Manual and slide control models are available.

Full range of trims, frets and fascias available. See pages 20-22

Specifications

Description: Full depth inset gas fire
Type of Heat: Radiant & Convected

Useful energy efficiency	60%
Energy efficiency class	F
Fuel type	Natural gas
Direct heat output	3.7kW

Fuel effect	Control type	Model Number
Coal	Manual	GICC00MN
	Slide	GICC00SN

Safety: Flame Supervision Device & Oxygen Depletion Sensor
Air vent required: Not normally

Dimensions

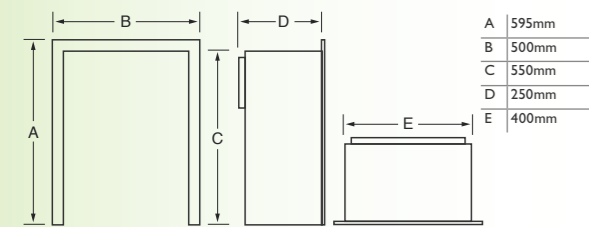

Dimensions A & B refer to Profiled trim only



Arana, Profiled trim in brass, Bauhaus fret in gold

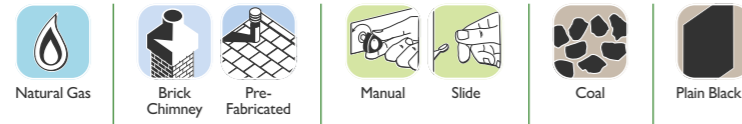

high efficiency Balanced Flue

Hearth Inset – Glass Fronted

Fantasy BF



The Fantasy Balanced Flue is the perfect solution for those who like the look of a full depth fire but don't have a standard chimney or flue in their home. With 93.5% energy efficiency, this glass fronted fire is the most efficient product in our range and offers an impressive 3.9kW heat output.

The Fantasy BF comes in a choice of manual, Easy Flame or thermostatic remote control and can be teamed with a large number of Global trims and frets. This fire can be installed easily into most standard cavity walls when fitted with a 3" rebated fire surround.

Full range of trims, frets and fascias available. See pages 20-22

Specifications

Description: Full depth inset gas fire
Type of Heat: Radiant & Convected

Useful energy efficiency	93.5%
Energy efficiency class	B
Fuel type	Natural gas
Direct heat output	3.9kW

Fuel effect	Control type	Model Number
Natural Gas	Manual	GBFC00MN2
	Easy Flame	GBFC00EN3
Coal	Remote	GBFC00RN3
	Manual	GBFL00MN2
Log	Remote	GBFL00RN2

Safety: Flame Supervision Device
Air vent required: No

Dimensions

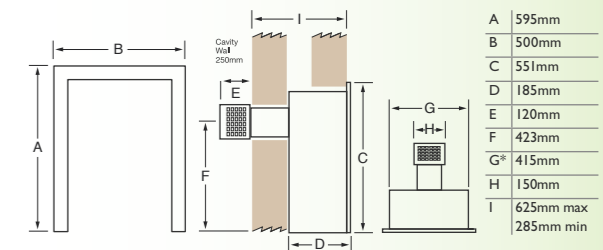

Dimensions A & B refer to Profiled trim only. *Dimensions differ on Easy Flame control models. Please refer to installation manual. An optional flue extension is available to increase the maximum flue length to 1010mm on manual models and 973mm on Easy Flame models.



Fantasy BF coal, Signature trim in black nickel & black, Daisy fret in black nickel

Fantasy BF logs, Signature trim
Daisy fret in satin silver & chrome



high efficiency Balanced Flue

Hearth Inset – Glass Fronted

Corda BF



The super slim Corda Balanced Flue has been specifically designed for homes without a chimney and its slim depth allows it to be easily installed into a standard cavity wall.

This glass fronted product has an incredible 80% energy efficiency and comes with a choice of satin brass or satin silver trim which can be complemented with any Global fret (see pages 21).

Specifications

Description: Slimline inset gas fire
Type of Heat: Radiant & Convected

Useful energy efficiency	80%
Energy efficiency class	E
Fuel type	Natural gas
Direct heat output	2.7kW

Fuel effect	Control type	Trim	Model Number
Coal	Manual	Satin Brass	GBFC10MN
		Satin Silver	GBFC30MN

Safety: Flame Supervision Device
Air vent required: Not normally

Dimensions

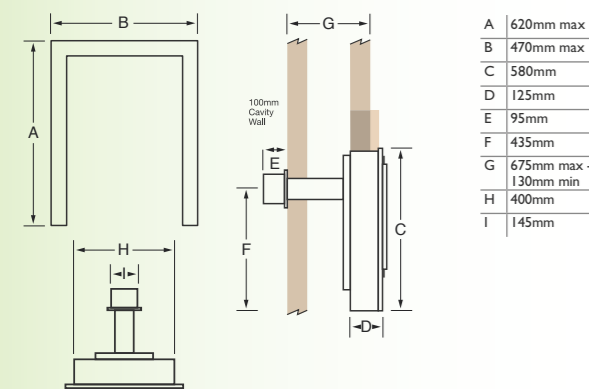

Corda BF trim and Aegis fret in satin silver

Corda BF, trim in brass, Aegis fret in brass

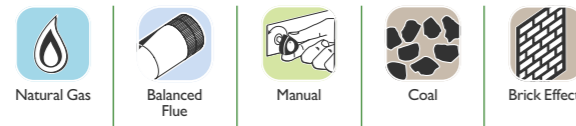

standard fires Conventional Flue

Hearth Inset – Open Fronted

Corda



The slimline Corda gas fire features an attractive coal fuel bed and dancing flame effect. It is suitable for installation in to almost any home, to fit a standard brick chimney, pre-fabricated flue or pre-cast (BS EN 1858). Available in a choice of manual or convenient slide control.

Full range of trims, frets and fascias available. See pages 20-22.

Specifications

Description: Slimline inset gas fire
Type of Heat: Radiant

Useful energy efficiency	53.1%
Energy efficiency class	F
Fuel type	Natural gas
Direct heat output	3.1kW

Fuel effect	Control type	Model Number
Coal	Manual	GCMC00MN
	Slide	GCMC00SN

Safety: Flame Supervision Device & Oxygen Depletion Sensor
Air vent required: Not normally

Dimensions

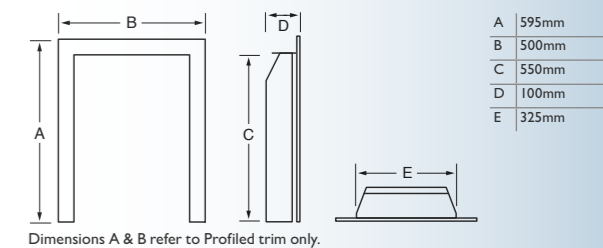

Corda, Signature trim in brass & black, Daisy fret in antique brass

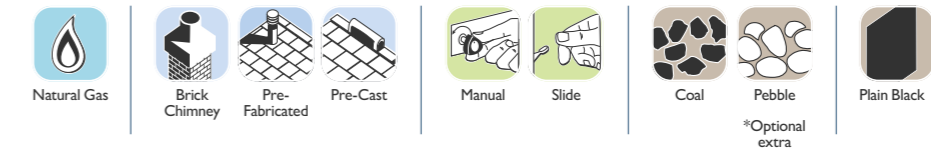

Karara

The Karara gives the appearance of a full depth fuel bed on a slimline gas fire. Designed for easy installation in to any chimney or flue, including pre-cast (BS EN 1858), this stylish fire is both versatile and affordable. This fire comes complete with a plain brass effect or satin silver trim.

Full range of trims, frets and fascias available. See pages 20-22

Specifications

Description: Slimline inset gas fire
Type of Heat: Radiant

Direct Heat Output	2.7kW
Fuel type	Natural gas

Fuel effect	Control type	Model Number	Trim
Coal	Manual	GSRC10MN	Brass
Coal	Manual	GSRC30MN	Satin Silver
Pebble	Manual	GSRP30MN	Satin Silver

Safety: Flame Supervision Device & Oxygen Depletion Sensor
Air vent required: Not normally
This product is not suitable for primary heating purposes

Dimensions

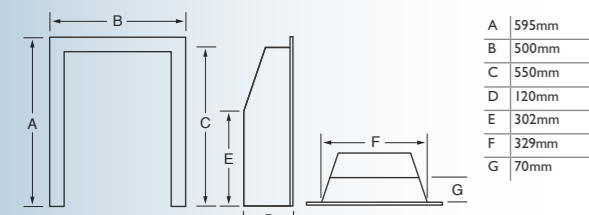

Dimensions A & B refer to Profiled trim only.



Karara coal, Standard trim in brass, Blenheim fret in brass

Karara *pebble, Standard trim in satin silver, Aegis fret in satin silver

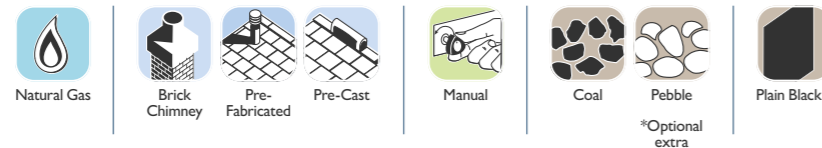

Fantasy



The Fantasy features an outstanding coal or pebble fuel effect and beautiful flame picture. This open-fronted fire provides a maximum heat output of 2.7kW and can be installed into most chimney or flues, including precast (BS EN 1858) when fitted with a 3"/75mm rebated surround.

Full range of trims, frets and fascias available. See pages 20-22

Specifications

Description: Mid depth inset gas fire
Type of Heat: Radiant

Direct Heat Output	2.7kW
Fuel type	Natural gas

Fuel effect	Control type	Model Number
Coal	Manual	GRDC00MN
Coal	Slide	GRDC00SN
Coal	Remote	GRDC00RN2

This product is not suitable for primary heating purposes
Safety: Flame Supervision Device & Oxygen Depletion Sensor
Air vent required: Not normally

Dimensions

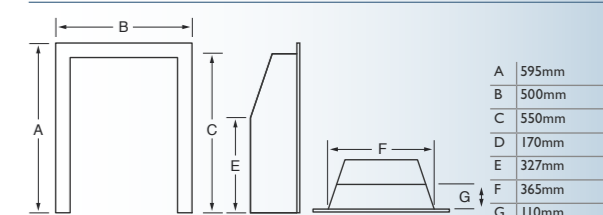

Dimensions A & B refer to Profiled trim only.



Fantasy Coal, Signature trim in satin silver & chrome, Daisy fret in satin silver & chrome

Fantasy *Pebble, Deluxe Contemporary fascia in satin silver

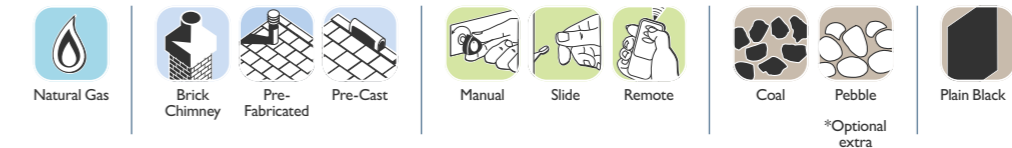

Fascia options

Arcadia

The Arcadia is a one-piece cast iron fascia in a combination of black painted with optional colour plated finish. Suitable for all Global hearth inset gas fires excluding Corda BF. Unsuited for Easy Flame Control systems.



BLACK & GOLD



BLACK & CHROME

Contemporary

The Contemporary is a one-piece fabricated steel fascia. Suitable for all Global hearth inset gas fires excluding Arana Plus, Corda BF and Fantasy BF. Unsuited for slide control or Easy Flame Control systems.



BRASS



CHROME



SATIN SILVER

Embrace

The Embrace fascia is a one-piece cast iron fascia in a combination of black painted and optional colour plated finish. Suitable for all Global hearth inset gas fires excluding Corda BF. Unsuited for Easy Flame Control systems.



GOLD & BLACK



CHROME & BLACK



BLACK NICKEL & BLACK

Deluxe Contemporary

The Deluxe Contemporary is a one-piece fabricated steel fascia with angled form. Suitable for all Global hearth inset gas fires excluding Corda BF and Fantasy BF. Unsuited for slide control systems.



ANTIQUÉ BRASS



SATIN SILVER



BLACK

Dalliance

The Dalliance is a one-piece fabricated steel fascia.

HEARTH INSET

Suitable for all Global hearth inset gas fires excluding Corda BF.



CHROME



SATIN SILVER



BLACK

Delta

The Delta is a one-piece fabricated steel fascia.

WALL INSET

Suitable for Delta HE. Unsuited for slide control systems.



CHROME

Signature

The Signature is a one-piece fabricated steel fascia. Suitable for all Global hearth inset gas fires excluding Corda BF. Brass & Black finish is unsuitable for Fantasy BF.



BRASS & BLACK



CHROME & BLACK



SATIN SILVER & CHROME



BLACK NICKEL & CHROME



BLACK NICKEL & BLACK

Fret options

Blenheim 16"



BRASS



ANTIQUÉ BRASS



CHROME



ANTIQUÉ CHROME



BLACK

Traditionally Styled Frets

Daisy 16"



ANTIQUÉ BRASS

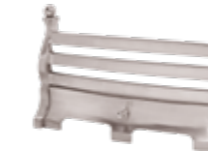

SATIN SILVER & CHROME



BLACK NICKEL

Aviva 16"



CHROME



BLACK NICKEL

Contemporary Styled Frets

Grace 16"



BRASS



CHROME



SATIN SILVER & CHROME

Bauhaus 18"



GOLD



CHROME



SATIN SILVER

Aegis 18"



BRASS



SATIN SILVER



BLACK



BLACK NICKEL



BLACK

Trim options

Signature

The Signature is a quality steel fabricated trim in a range of metallic and paint finishes. Suitable for all Global hearth inset gas fires excluding Corda BF model. Brass & Black finish is unsuitable for Fantasy BF model.



BRASS & BLACK



CHROME & BLACK



SATIN SILVER & CHROME



BLACK NICKEL & CHROME



BLACK NICKEL & BLACK

Profiled

The Profiled is a quality steel fabricated trim in a range of metallic and paint finishes. Suitable for all Global hearth inset gas fires excluding Corda BF.



BRASS



CHROME



SATIN SILVER



BLACK

Standard

The Standard is a quality steel fabricated trim in a range of metallic and paint finishes. Suitable for all Global hearth inset gas fires excluding Corda BF.



BRASS



CHROME



SATIN SILVER



BLACK

Ultimo

The Ultimo is a cast iron trim with a black painted and optional colour plated finish. Suitable for all Global hearth inset gas fires excluding Corda BF. Unsuitable for Easy Flame Control systems.



GOLD & BLACK



CHROME & BLACK



BLACK NICKEL & BLACK

Curved

The Curved trim is made from a high quality extruded aluminium and is available in a black paint finish. Suitable for all Global hearth inset gas fires excluding Corda BF. Unsuitable for Slide control models.



BLACK

Online inspiration & information

Tap into a wealth of knowledge and discover everything you need to know about purchasing, fitting & servicing your Global fire.

- ▣ Use our intelligent search tools to find your perfect gas fire
- ▣ Find your nearest approved Global stockist
- ▣ Download installation and user manuals
- ▣ Register your guarantee
- ▣ Interactive updated blogs to keep you informed and intrigued

www.globalgasfires.co.uk

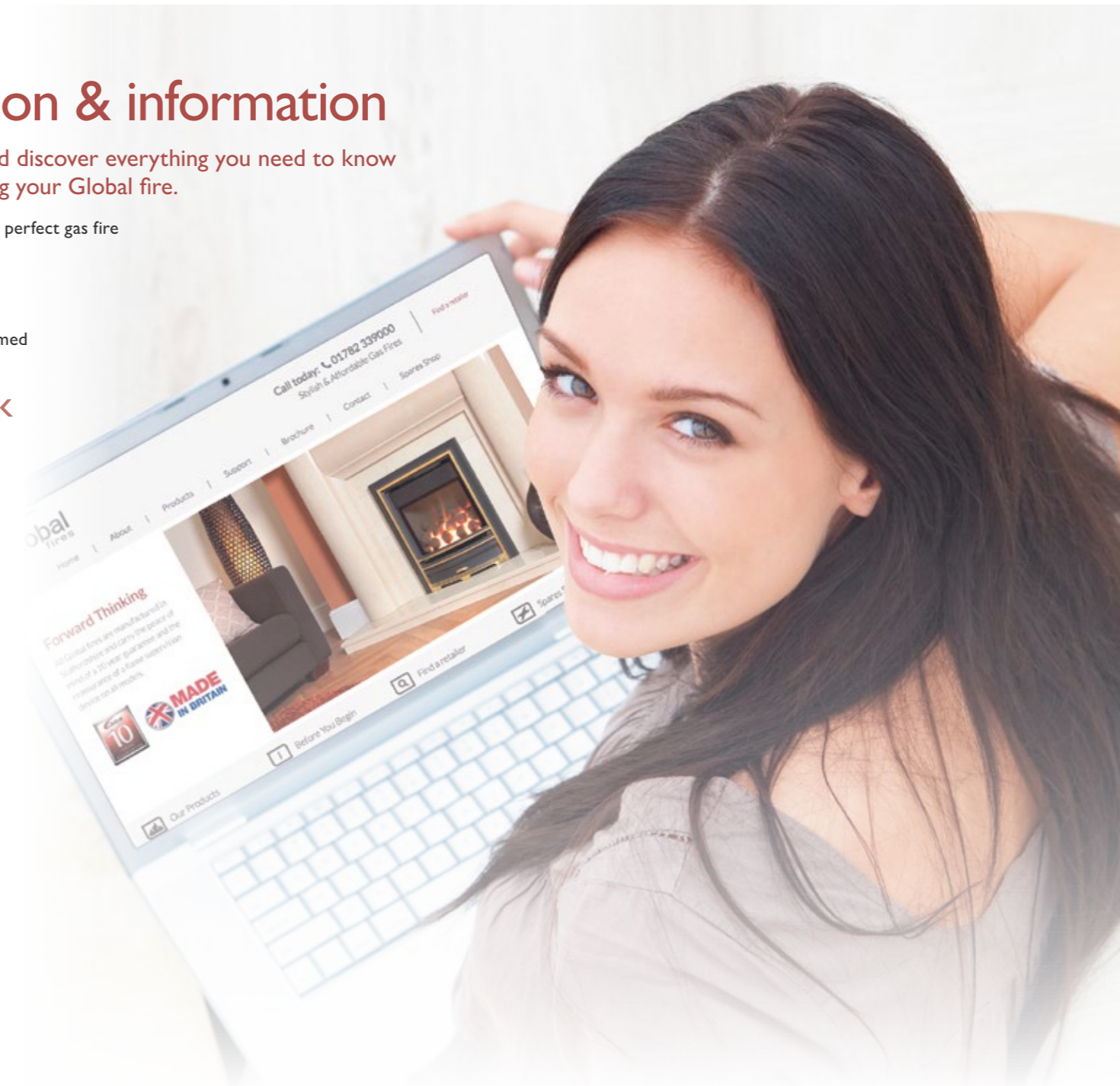



WARNING BFM Europe Limited is a Gas Safe Register company. We recommend that all of our fires are installed by Gas Safe Register engineers in accordance with our instructions.

DISCLAIMER Our policy is one of constant development and improvement. We therefore reserve the right to revise designs and specifications of our products without formal notice, patents pending. We always recommend our products be viewed in an approved showroom before purchase. Whilst we have taken every care in the preparation of this brochure it is not intended to replace the installation manual which provides more detailed information. Photography is for illustration purposes only and although every effort has been made to ensure accurate reproduction of typical installations and flame pictures they may vary according to fire model and flue types. We accept no liability for any loss or damage arising directly or indirectly from the use of this brochure. We recommend that all our fires are used in conjunction with central heating and not as a primary source of heat. In the interests of personal safety a suitable fireguard is recommended when children, the elderly and the infirm are present. (This brochure is copyright 2022 and must not be reproduced in whole or in any part without prior written permission).



BFM Europe Ltd, Gordon Banks Drive, Trentham Lakes, Stoke-on-Trent ST4 4TJ
Tel: 01782 339000 www.globalfires.co.uk Email: sales@bfm-europe.com