



At the heart of your home

**16" SSL OPULENCE BLACK NICKEL**  
**16" SSL OPULENCE CHROME**

**FLAVEL FIRES MODEL NO.: FPFOB NRE**  
**FLAVEL FIRES MODEL NO.: FPFOCHRE**

**Packing Checklist**

- Electric Fire
- Trim
- Remote Control Handset
- Vermiculite Bag
- Ceramic Log Set
- Coal Set
- White Stones
- Guarantee Card
- Instruction Manual

**\* THIS PRODUCT REQUIRES 2 X AAA BATTERIES FOR USE IN THE HANDSET (NOT SUPPLIED)**

**IMPORTANT**

PLEASE READ THESE INSTRUCTIONS CAREFULLY BEFORE  
INSTALLATION AND USE OF THIS ELECTRIC FIRE.  
RETAIN FOR FUTURE REFERENCE.

This appliance is not intended for use by persons (including children) with reduced physical, sensory or learning disabilities, or lack of experience and knowledge, unless given supervision or instruction concerning use of the appliance by a person responsible for their safety.

**If the supply cord is damaged, it must be replaced by the manufacturer, its service agent or similarly qualified persons in order to avoid a hazard.**

## **IMPORTANT SAFETY ADVICE**

**WHEN USING AN ELECTRICAL APPLIANCE, BASIC PRECAUTIONS SHOULD ALWAYS BE FOLLOWED TO REDUCE THE RISK OF FIRE, ELECTRIC SHOCK AND INJURY TO PERSONS, INCLUDING THE FOLLOWING IMPORTANT SAFETY ADVICE.**

This instruction can be also downloaded from our company website.

This appliance can be used by children aged from 8 years and above and persons with reduced physical, sensory or mental capabilities or lack of experience and knowledge if they have been given supervision or instruction concerning use of the appliance in a safe way and understand the hazards involved. Children shall not play with the appliance. Cleaning and user maintenance shall not be made by children without supervision.

Children of less than 3 years should be kept away unless continuously supervised.

Children aged from 3 years and less than 8 years shall only switch on/off the appliance provided that it has been placed or installed in its intended normal operating position and they have been given supervision or instruction concerning use of the appliance in a safe way and understand the hazards involved. Children aged from 3 years and less than 8 years shall not plug in, regulate and clean the appliance or perform user maintenance.

**CAUTION — Some parts of this product can become very hot and cause burns. Particular attention has to be given where children and vulnerable people are present.**



**WARNING:** In order to avoid overheating, do not cover the heater.

Do not use this heater in the immediate surroundings of a bath, a shower or a swimming pool.

The heater must not be located immediately below a socket outlet.

Do not use this heater with a programmer, timer, separate remote-control system or any other device that switches the heater on automatically, since a fire risk exists if the heater is covered or positioned incorrectly.

There is possible danger of installation close to curtains and other combustible materials.

Do not use this heater if it has been dropped.

Do not use if there are visible signs of damage to the heater.

Use this heater on a horizontal and stable surface, or fix it to the wall, as applicable.

**CAUTION:** In order to avoid a hazard due to inadvertent resetting of the thermal cut-out, this appliance must not be supplied through an external switching device, such as a timer, or connected to a circuit that is regularly switched on and off by the utility.

**DO NOT** cover or obstruct the airflow to the front of the heater. This is to avoid over-heating of the product.

**DO NOT** leave the heater unattended while it is in use. Always turn the appliance to the OFF position and switch off at the mains socket when not in use.

**DO NOT** leave children unsupervised whilst the appliance is switched on

**DO NOT** operate this appliance with a damaged cord or plug, or after the appliance malfunctions, has been dropped or damaged in any way.

**DO NOT** install a timer switch to operate the appliance.

**DO NOT** use this appliance as a freestanding appliance. It must always be fitted into a fireplace opening.

**DO NOT** insert or allow objects to enter any ventilation or exhaust openings on the appliance. To prevent possible damage do not block air intakes or exhaust openings in any manner.

**DO NOT** place this appliance near flammable materials, surfaces or substances, as there may be a risk of fire. Keep flammable materials, surfaces or substances at least 1 metre away from the front of the product.

**DO NOT** switch on the fire if volatile vapours are present in the room.

**DO NOT** use this appliance in any areas where petrol, paint or other flammable liquids are stored e.g. a garage or a workshop as the appliance contains components capable of producing a spark.

**DO NOT** let bare skin touch any hot surfaces to avoid burns and personal injury. The heater vent will get hot when in use.

**DO NOT** use outdoors.

**CAUTION-** Some parts of this product can become hot and cause burns. Particular attention has to be given where children and vulnerable people are present.

**This appliance is for household use only.**

# Product Technical Data Sheet

<b>Supplier Name / Trademark</b>	FLAVEL
<b>Supplier Model Identifier</b>	B-1046557 B-1046558
<b>Voltage</b>	230v AC 50HZ
<b>Fuse</b>	13Amp
<b>Nominal Heat Output (Measured)</b>	1.6 kW
<b>Minimum Heat Output (Indicative)</b>	0.8 kW
<b>Maximum Continuous Heat Output</b>	1.6 kW
<b>Auxiliary Electricity Consumption At Nominal Heat Output</b>	1.623kW
<b>Auxiliary Electricity Consumption at Minimum Heat Output</b>	0.808kW
<b>Auxiliary Electricity Consumption at Standby Mode</b>	0.00109kW
<b>Manufacturers Name and Address</b>	BFM Europe Ltd. Gordon Banks Drive, Trentham Lakes, Stoke-on-Trent, Staffs, ST4 4TJ Tel:(01782) 339000

## Fire Dimensions

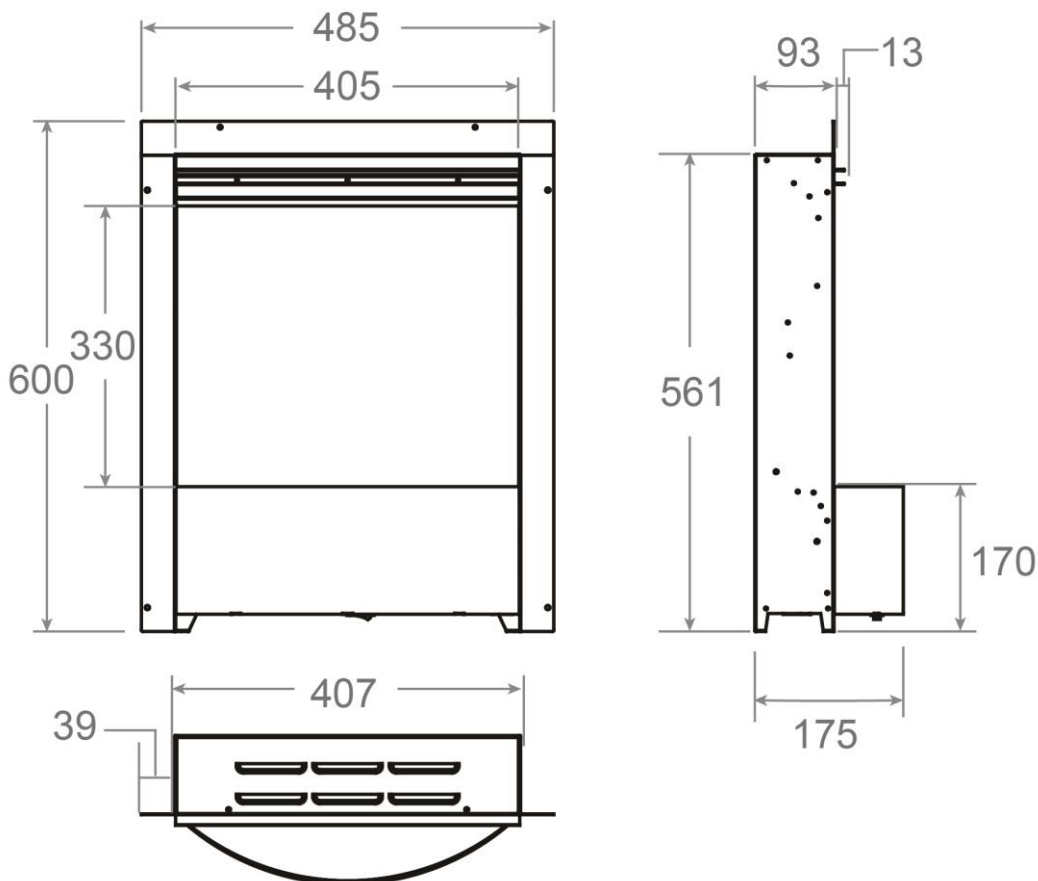

## Unpacking

Remove and discard the plastic bag.

Be responsible when handling the packing materials.

Keep the original packaging for future transportation and/or storage.

Check all accessories are removed from the packaging before storing it away for future use.

**KEEP PLASTIC BAGS AWAY FROM CHILDREN!**

## Choosing a suitable location

This electric fire is designed to be fitted within an existing brick / masonry chimney breast which must be dry with the chimney capped off using a suitable chimney cap.

The appliance must be kept away from any source of damp or moist conditions. Avoid any close contact with water.

Important Notice: To reduce heat losses and to prevent any chimney up draught affecting the operation of your fire we recommend that the chimney is blocked off.

The chimney breast, wall or fireplace must be of sound construction and all fixings used must be suitable for the type of wall. If there is any doubt regarding the suitability of the installation site please contact your supplier.

From the front of the fire ensure that there is a minimum clearance of 50mm between any non-combustible materials. For combustible material clearances please consult with the manufacturer.

The fire can be connected direct or plugged into a mains socket which can be sited on the right hand side of the fire.

Ensure that the plug socket-outlet connection for this appliance is accessible. It **MUST** be readily accessible for easy electrical isolation in the event of servicing and replacing components etc. This appliance **MUST NOT** be located immediately below an electrical socket-outlet.

## Installation

**Installation must be carried out by a qualified and competent person.**

The fireplace opening sizes required to install the fire are:

**16" SSL OPULENCE BLACK NICKEL**

**16" SSL OPULENCE CHROME**

Height = 565mm to 590mm

Width = 420mm to 455mm

Depth = 100mm minimum

Connect the appliance to single-phase AC supply of the voltage specified on the rating plate. Should the fire be connected directly into the mains supply, then a fused switched spur with a 13 amp fuse must be fitted. It is imperative that the power supply is capable of handling a load of 1600 watts (1.6kw).

This appliance must be earthed. Allow sufficient flex to enable the fire to be removed from the opening. **Do not use an extension lead.**

**Always ensure that all electrical work complies with the relevant Building Regulations and the Electrical Code of Practice. All electrical work should be carried out by a qualified electrician.**

# Operating the Fire

This fire can be operated using 2 methods:

**Remote Control** using the included remote-control handset

**App Control** using smartphone or tablet

**ON / OFF Power Switch**

**ON / OFF Wifi Switch**

There are 2 switch at the bottom of the fire.

The Power switch is used to turn the mains supply to the appliance ON or OFF. This needs to be in the ON position for both WIFI and remote operation.

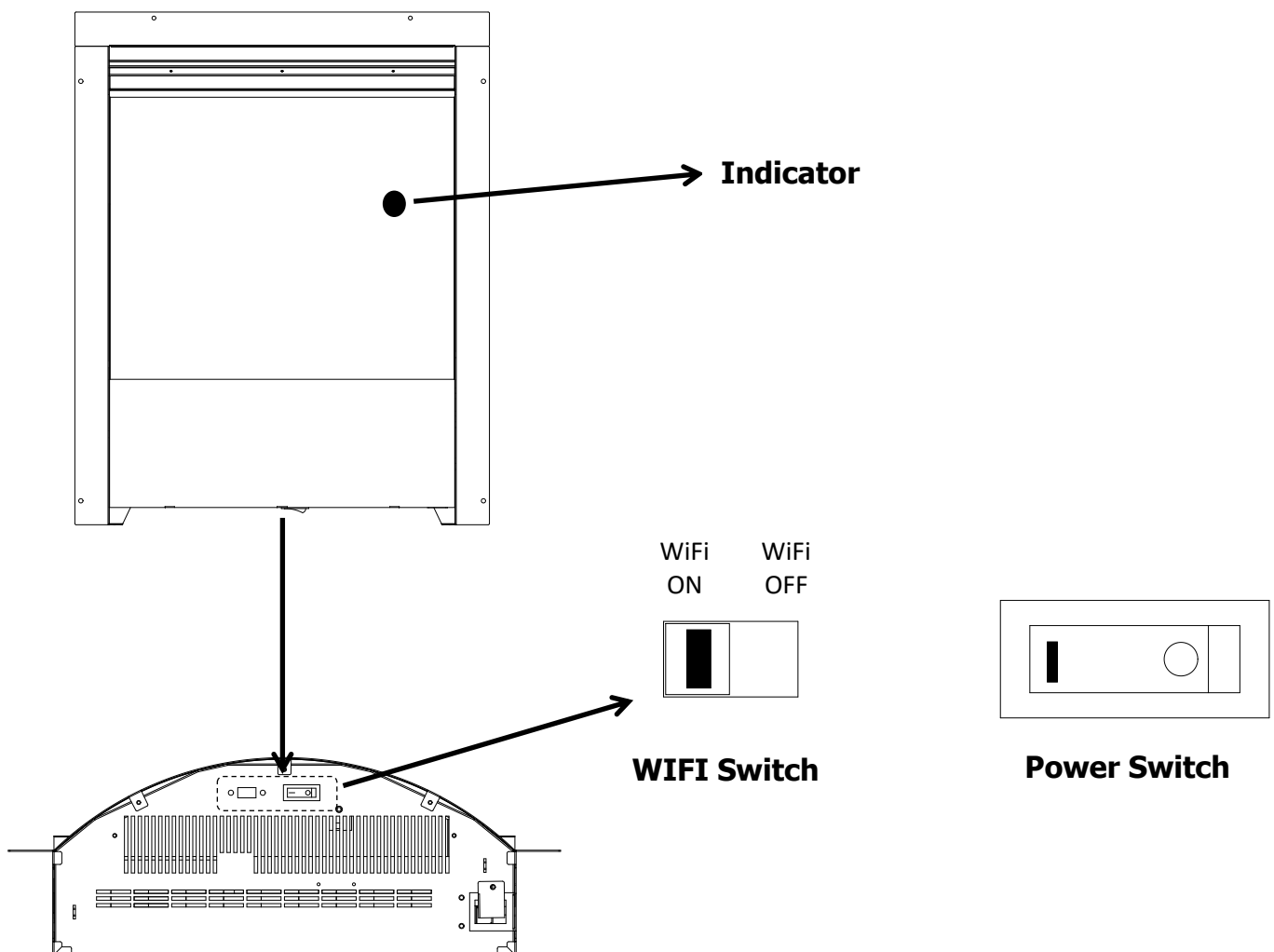

## Remote Control

Remove the battery cover on the rear and insert 2 x AAA batteries ensuring the batteries are fitted correctly. Refit the cover. Please ensure old batteries are disposed of responsibly by contacting your local authority about recycling schemes.

Ensure that the ON / OFF Power Switch on the fireplace is in the ON position.

### OPERATING INSTRUCTION WITH REMOTE CONTROL

To use the remote handset ensure it is pointed directly towards the fire and press the appropriate button to operate the fire.



#### **Power**

The Power Button turns the fireplace ON and OFF.



#### **Heat**

The Heat Button is used to turn the heater ON and OFF. Use the “+” or “-” to adjust the heat settings. One blue indicator (low - 800W/0.8kW), two orange indicator (high - 1.6kW/1600W), three blue/orange (auto-app controlled).



#### **Flame**

The Flame Button turns the flame ON and OFF. Press “+” or “-” button to set the flame colour. There are 3 flame colours (Orange, Orange & Red, Orange & Blue).



#### **Ember Bed**

The Ember Bed Button turns the ember bed light ON and OFF.



#### **Timer**

The Timer Button turns the timer ON with 1 hour and has an audible beep.



#### **Brightness**

The Brightness of flame and ember bed can be adjusted by pressing the flame or ember bed button followed by the brightness button, then using the “+” or “-” to set the desired brightness level. There are 10 brightness levels that can be set.



#### **Speed**

The Speed Button is used to adjust the flame speed. There are 10 speeds that can be set.

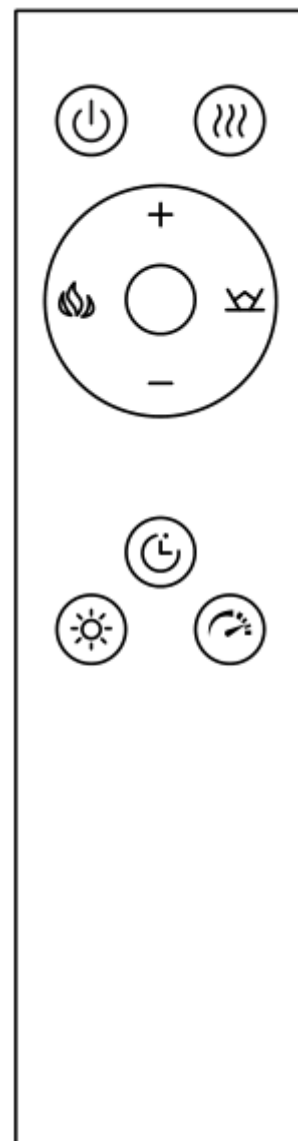

# TuyaSmart Life Control

The TuyaSmart Life app can be downloaded from the IOS App Store or the Google Play Store by either searching for TuyaSmart Life Control or by scanning the QR code using a smart phone or tablet.



## WIFI Setting and fireplace operation

Ensure that the on/off WIFI switch is in the "on" position (page 7).

If the power on/off switch (page 7) is turned off after pairing to the App, it will lose pairing if turned on using the remote. Using the App to switch on, will retain pairing.

1. Create an account and log in.
2. Ensure power switch and WiFi are to the positions shown on page 7, turn the fire on with the remote handset to activate pairing (pairing light will flash).
3. When you log in, the APP will scan, press the "+" (FIG. 1) and add the fireplace to APP (FIG. 2) automatically. Touch "add" to enter in FIG. 3. Touch "Next" to enter (FIG. 4). Enter your WiFi username and password, which will add successfully (FIG. 5). Touch "Done" to finish WiFi setting (FIG. 5).

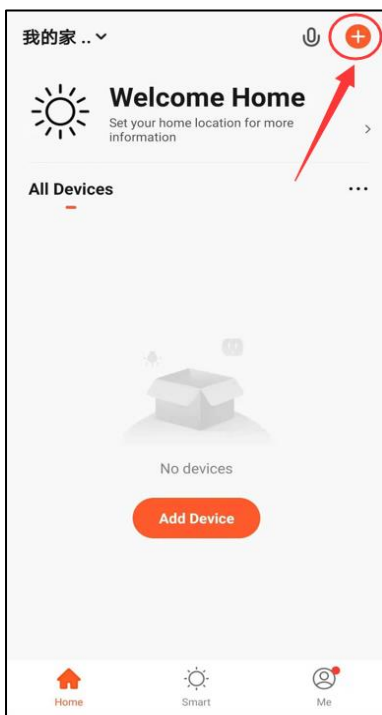

FIG.1

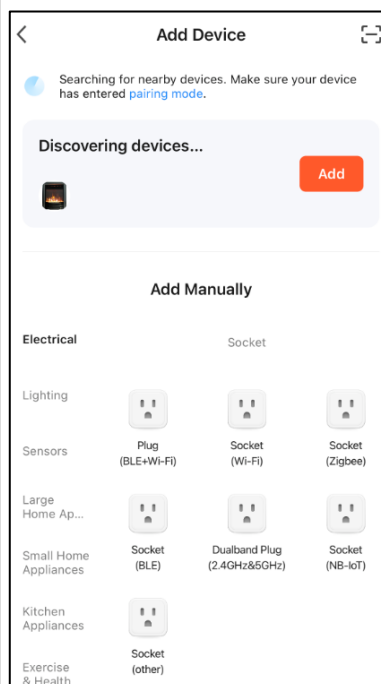

FIG.2

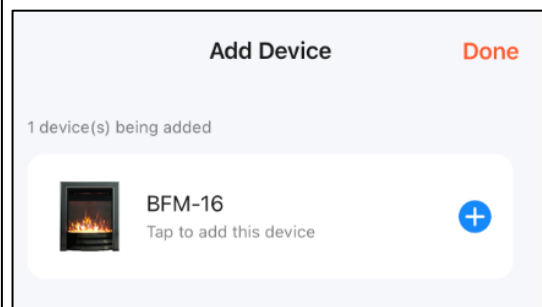

FIG.3

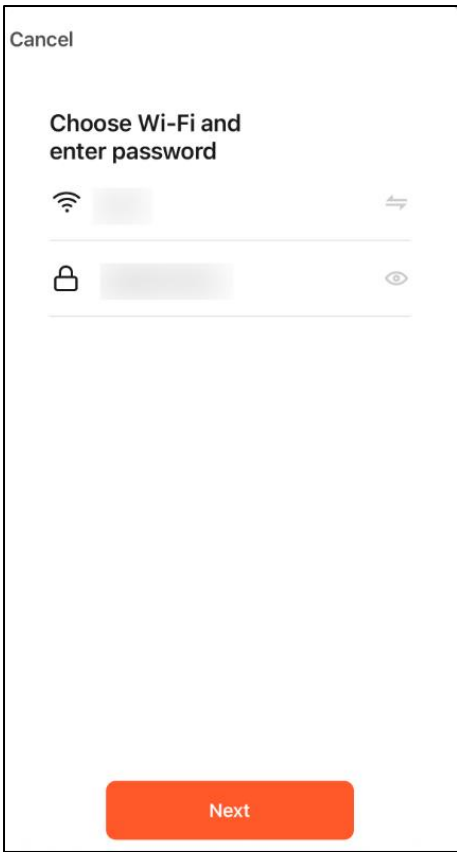

FIG.4

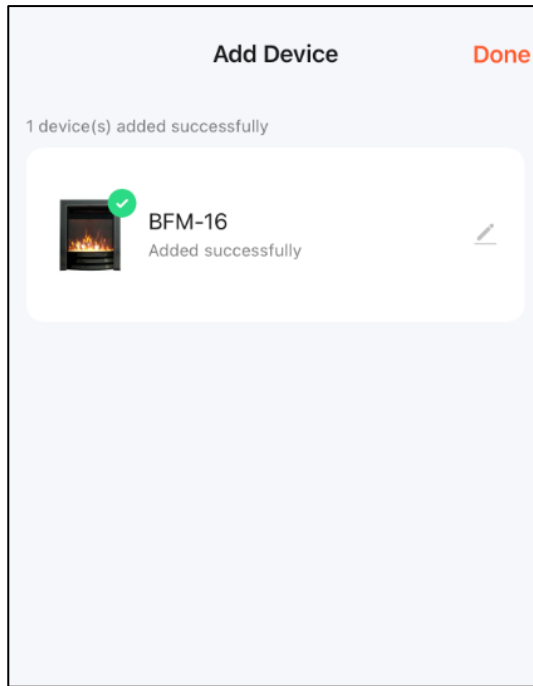

FIG.5

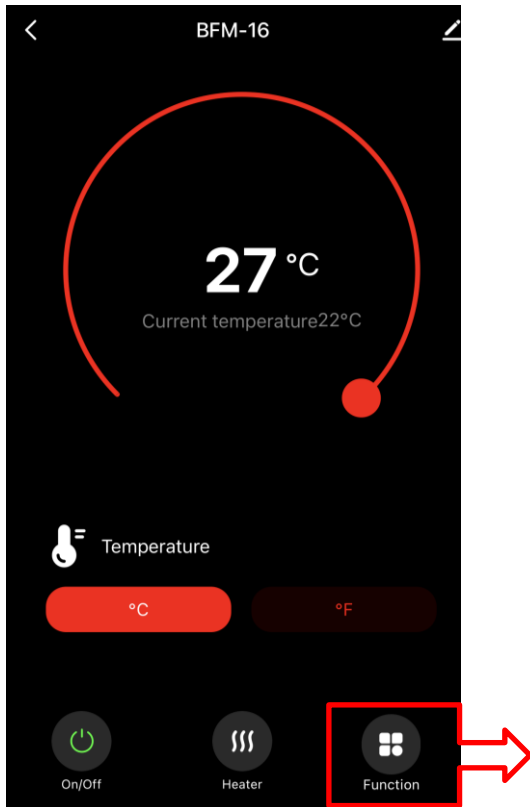

FIG.6

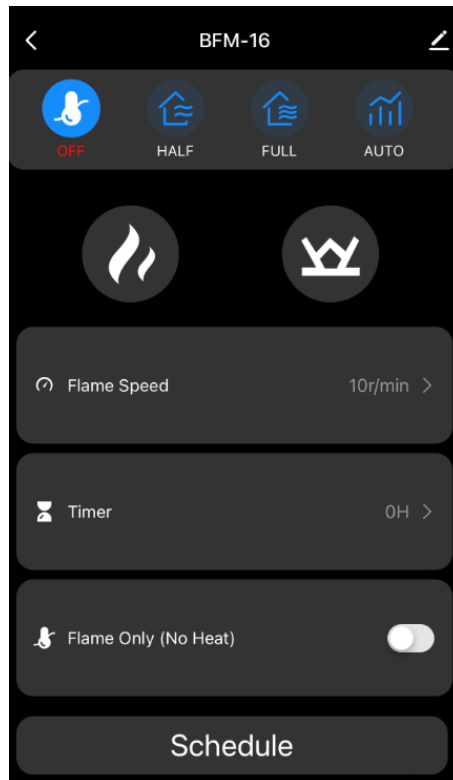
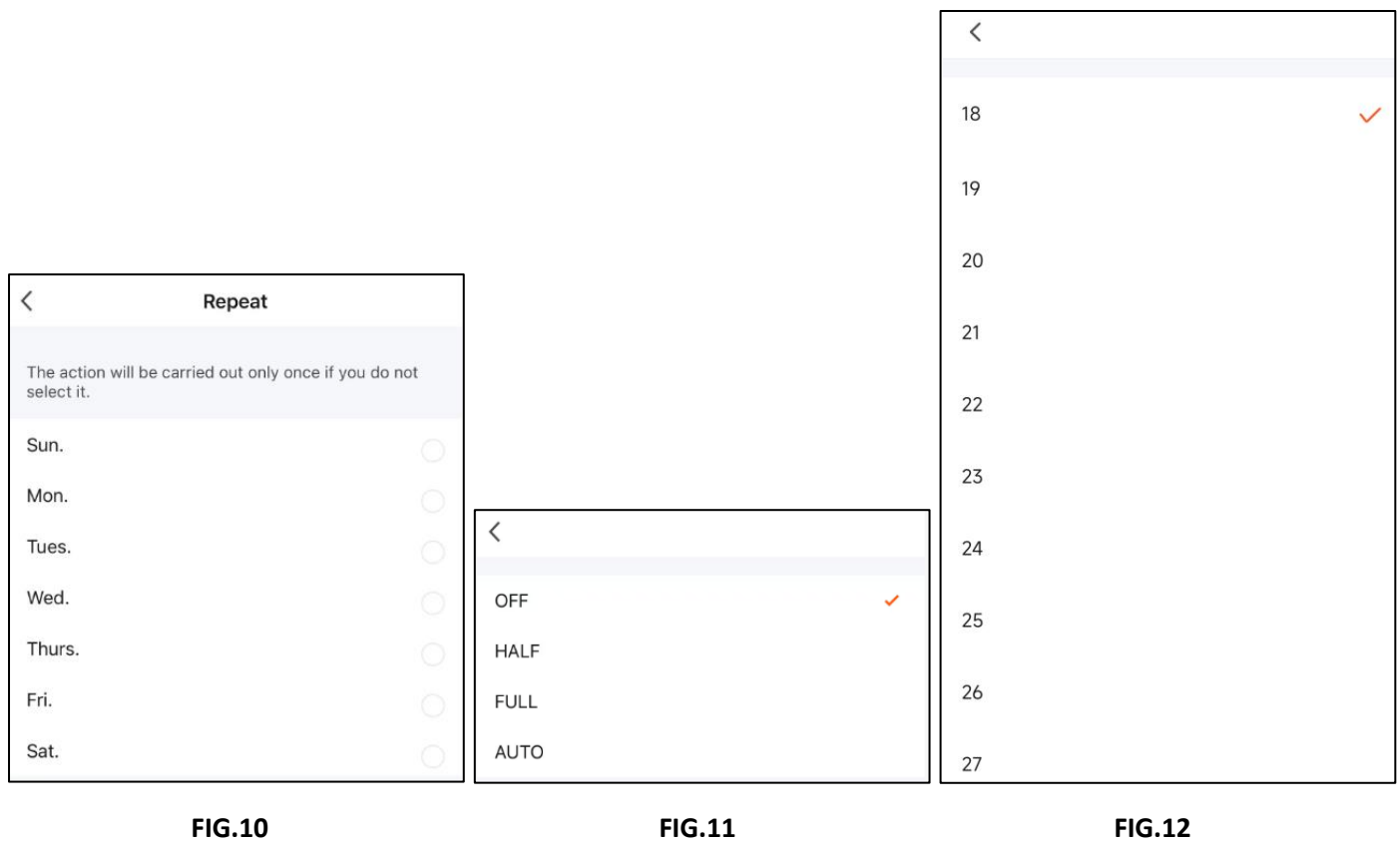
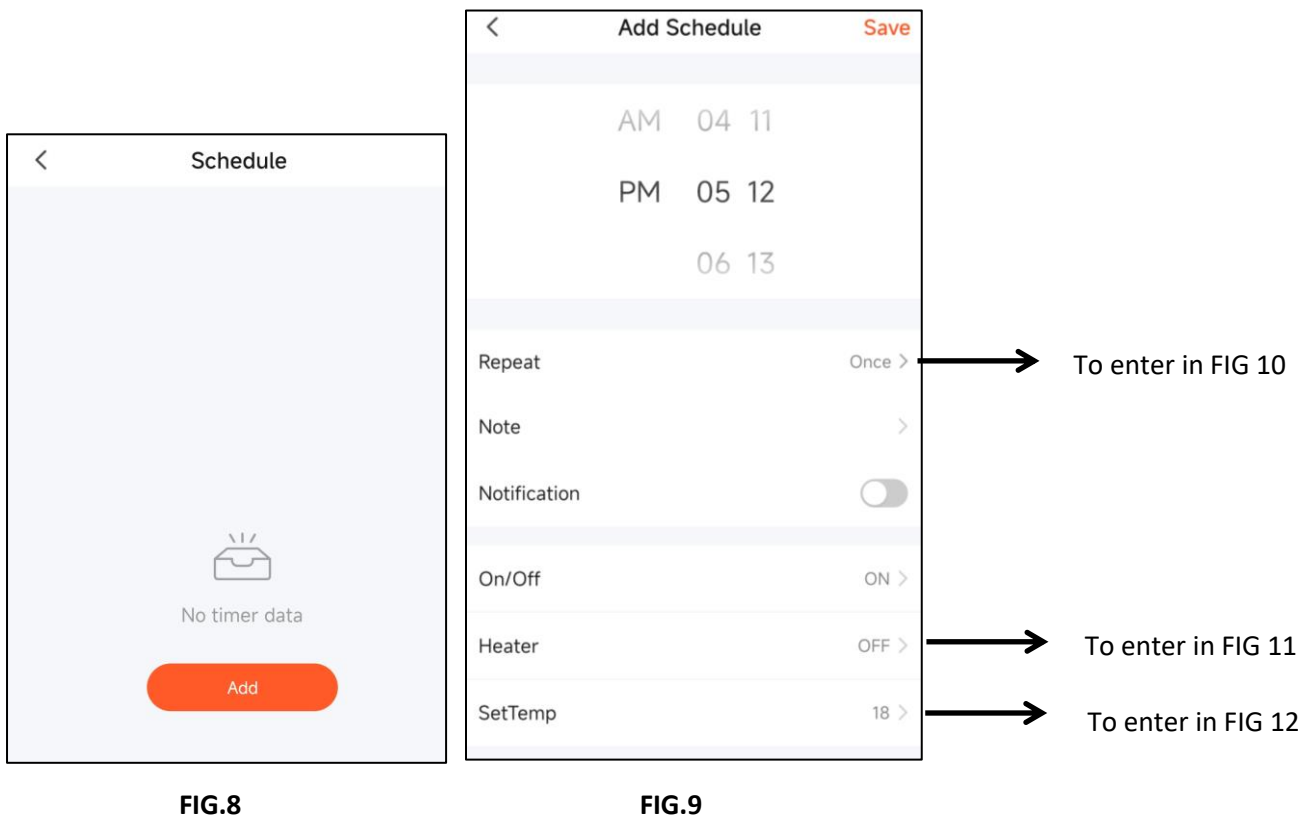

FIG.7

You are now in the interface and can operate the fireplace via WIFI as shown in figure 6 & 7.

# Schedule Setting — just like setting clocks

press the “Schedule” (FIG. 7) to enter in FIG. 8 & FIG. 9.



**NOTE: If the The TuyaSmart Life app temperature is set below the current room temperature then the heater will not operate until the room temperature has dropped. At this moment, the indicator light in the middle of the screen will turn on red/blue/orange colours and flash.**

## IMPORTANT

This fire is fitted with an automatic thermal cut-out safety feature to reduce the risk of damage to fire due to overheating. If the fire overheats the heater element will cut out whilst the fan will still continue to run to allow the fire to cool down sufficiently.

Once the fire has cooled down the thermal cut-out will reset itself and switch the heater back on. If the problem persists switch the fire off and disconnect the power at the switch and plug socket. Check that the heater warm air outlets and the inlets are not obstructed (the outlets and inlets are situated on the underside of the fire body).

If the heater is still not operating correctly disconnect the fire and seek expert advice.

## Maintenance Instructions

Always remove the plug from the socket-outlet and allow the heater to cool down before cleaning. User maintenance should only be carried out by a competent person.

Light accumulated dust may be removed from the fire with a soft dry cloth.

The exterior surface of the fire can be cleaned with a soft damp cloth (not dripping wet). Dry the exterior surface before operating the heater.

Household glass cleaner can be used on the fire glass.

## WARNING!

Do not immerse the heater in water.

Do not use any cleaning chemicals such as detergents and abrasives.

Do not allow the interior to get wet as this could create a hazard.

In the event of malfunction do not try to repair the appliance yourself as this may result in a fire hazard or electric shock.

## Environment



Do not dispose of electrical appliances as unsorted municipal waste. Use separate collection facilities. Contact your local government for information regarding the collection services available in your local area. If electrical appliances are disposed of in landfills or dumps hazardous substances can leak into the groundwater and get into the food chain, thus damaging your health and wellbeing.

When replacing old appliances with new ones the retailer is legally obligated to take away your old fire for disposal free of charge.

Table 3 for information requirements for electric local space heaters					P
Contact details:	BFM Europe Ltd, Gordon Banks Drive, Trentham Lakes, Stoke-on-Trent, ST4 4TJ.				
Model identifier(s):	B-1046557 FPFOBNRE		equivalent models:	B-1046558 FPFOCHRE	
Item	Symbol	Value	Unit	Item	Unit
Heat output			Type of heat output/room temperature control (select one)		
Nominal heat output	P <sub>nom</sub>	1,566	kW	Single stage heat output and no room temperature control	[no]
Minimum heat output (indicative)	P <sub>min</sub>	0,799	kW	Two or more manual stages, no room temperature control	[no]
Maximum continuous heat output	P <sub>max</sub>	1,566	kW	With mechanic thermostat room temperature control	[no]
Power consumption			With electronic room temperature control		[no]
In off mode	P <sub>o</sub>	0	W	Electronic room temperature control plus day timer	[no]
In standby mode	P <sub>sm</sub>	0,31	W	Electronic room temperature control plus week timer	[yes]
In Idle mode	P <sub>idle</sub>	0,31	W	Other control options (multiple selections possible)	
In network standby	P <sub>nsm</sub>	1,09	W	Room temperature control, with presence detection	[no]
Standby mode with display information or status			no	Room temperature control, with open window detection	[no]
Seasonal space heating energy efficiency in active mode	$\eta_{S,on}$	92,0	%	distance control option	[yes]
				adaptive start control	[no]
				working time limitation	[no]
				black bulb sensor	[no]
				self-learning functionality	[no]
				control accuracy	[no]
Remark:					
For electric local space heaters, the declared seasonal space heating energy efficiency $\eta_{S,on}$ cannot be higher than the measured value at the nominal heat output of the unit.					

# Warranty

Congratulations on the purchase of your electric fire. This fire by BFM Europe Ltd is guaranteed for 3 years from the date of purchase against faulty materials or workmanship.

If purchased in the UK please note the 3-year guarantee comprises of 12 months of parts and labour with an extended 24 months of parts only. If your fire is found to be defective within 12 months from the date of purchase, we or our authorized agent will repair the faulty component on site.

If purchased in the EU please consult the guarantee card that is supplied with your product by the approved Flavel Fires Proflame SSL retailer for warranty terms and conditions.

This warranty does not cover consumable items which have a limited lifespan. If a problem should occur, the nature of the problem together with the date of purchase and installer information should be immediately reported to the retailer that the fire was purchased from. Proof of purchase will be required so the original invoice should be retained.

B-1046586

Issue 1



At the heart of your home

BFM Europe Ltd  
Gordon Banks Drive  
Trentham Lakes  
Stoke-on-Trent  
ST4 4TJ

Technical Queries: 01782 339039

Service Fault Enquiries: 01782 339008

**Spare Parts - [www.bfm-partfinder.co.uk](http://www.bfm-partfinder.co.uk)**