

FLAVEL

At the heart of your home

Gas Fires
2022/23



BRITISH MANUFACTURING





At the heart of your home

Welcome to Flavel



BFM Europe

BRITISH FIRE MANUFACTURERS

Today BFM Europe is the fastest growing domestic fire producer in the country with an unequalled reputation for quality and service. Every Flavel branded gas fire is developed and manufactured in Britain at our purpose built, state-of-the-art facility in Stoke-on-Trent.



Every model* carries the peace of mind of a 7 year guarantee and the reassurance of the Flavel Airwatch System on all living flame effect fires. This device immediately cuts off the gas supply in the unlikely event of the flame being extinguished through blockage.

Our 7 year guarantee is subject to terms & conditions including annual services carried out by a Gas Safe Register engineer and annual replacement of the oxy-pilot assembly (or thermocouple on balanced flue models).



At Flavel we know how important it is to create a stylish and relaxing living environment. That's why we've developed this collection of affordable gas fires to complement all tastes and lifestyles. I believe our success stems from a combination of innovative design, investment in technology and the highest quality manufacturing standards. As a result all Flavel gas fires carry a 7 year guarantee to reflect my belief in their quality and durability.

This brochure has been designed to make the purchase of your new Flavel gas fire as simple as possible. I hope you will find it both informative and inspiring.



Flavel products are fully compliant with the Eco design directive Commission Regulation (EU) 2015/1188.

bsi. Product Testing & Certification

All our gas fires are independently tested, approved and verified by the British Standards Institution (BSI) to meet the latest standards for performance, safety and efficiency.

The BSI is an independent organisation. They are not owned by the government, industry or shareholders, which means that they can be totally objective with regards testing and certification. This gives their assessments more authority than those of an organization that has a vested interest in promoting its members.

They have some of the most experienced and knowledgeable staff in the world and are recognised internationally for their technical expertise, quality services and in-depth knowledge of gas and electrical testing and certification.

The wide-ranging capability of their testing facilities and the broad expertise and knowledge of their testing and certification staff ensures our products are rigorously tested with the utmost integrity.



Tested & Approved
Conforms to GB legislation

Contents

Guide to efficiencies and fire types.....4 - 5
Before you Begin - guide to icons 6

high efficiency

Conventional Flue

Wall Outlet – Glass Fronted

Curve..... 7

Wall Inset – Glass Fronted

Rocco HE..... 8
Jazz HE..... 9
Expression HE..... 10
Diamond HE..... 11
Windsor Contemporary HE..... 12

Wall Inset – Open Fronted

Windsor Contemporary Plus..... 13

Fireplace Suites – Glass Fronted

Sophia Suite..... 14-15

Hearth Inset – Glass Fronted

Romance.....16-17
Caress HE..... 18
Decadence HE & Decadence Slimline HE..19
Kenilworth HE..... 20
Linear HE.....21
Windsor Contemporary HE..... 22
Windsor Traditional HE..... 23

Hearth Inset – Open Fronted

Richmond Plus & Richmond.....24
Caress Plus & Caress..... 25
Calypso Plus & Calypso..... 26
Rhapsody Plus & Rhapsody..... 27
Decadence Plus..... 28
Linear Plus..... 29
Kenilworth Plus..... 30
Expression Plus.....31
Windsor Contemporary Plus..... 32
Windsor Traditional Plus..... 33
Stirling Plus.....34-35

Hearth Outlet – Glass Fronted

Emberglow..... 36
Renoir..... 37

Hearth Outlet – Open Fronted

Regent..... 38
Welcome..... 39
Strata..... 40
Misermatic.....41
Renaissance..... 42
Firenza..... 43

Balanced Flue

Wall Inset – Glass Fronted

Rocco BF 8
Jazz BF 9

Hearth Inset – Glass Fronted

Calibre BF.....44
Raglan BF.....45
Orchestra BF.....46

Fireplace Suites – Glass Fronted

Sophia Slimline BF..... 14-15

Hearth Outlet – Glass Fronted

Emberglow BF..... 36



Rocco HE - page 08



Orchestra BF - page 46

standard fires

Conventional Flue

Wall Inset – Open Fronted

Finesse 47
Windsor Contemporary.....48

Hearth Inset – Open Fronted

Waverley.....49
Linear..... 50
Caress Slimline..... 51
Windsor Contemporary,
Classic & Traditional 52-53
Melody..... 54

Hearth Outlet – Open Fronted

Regent LFE.....55



Waverley - page 49

Builders' Opening Sizes..... 58

high efficiency

Get up to 93.5% energy efficiency from your gas fire...

Flavel is a British manufacturer with a reputation for excellent quality gas fires. Our R&D team continue to invest in developing new technology to produce gas fires that save energy and as a result, help to keep costs down.

The Flavel high efficiency range combines exceptional heat output with lower running costs compared to standard gas fires.

Conventional Flue

Glass Fronted



Caress HE 86% – page 18

Our glass fronted high efficiency conventional flue fires have an energy efficiency of up to 86.3%. The glass panel across the front which concentrates radiant heat generated from the fuel bed and forces it directly into the room with less heat lost through the chimney. Convected heat is also produced by cool air drawn into the base of the fire through the heat exchanger and then emitted as warm air through the gap above the canopy, making these the most efficient conventional flue fires available.

Open Fronted



Linear Plus 68.3% – page 29

Our open fronted high efficiency conventional flue fires can reach an energy efficiency of up to 68.3%. These fires provide the look and feel of a real open fire providing both radiant and convected heat. Radiant heat is emitted from the coal effect fuel bed and the convected heat is generated by cool air drawn into the base of the fire which passes through a heat exchanger and is then emitted as warm air through the gap above the canopy.

Balanced Flue

Glass Fronted



Calibre BF 93.5% – page 44

Our glass fronted high efficiency balanced flue fires have an energy efficiency of up to 93.5%. Designed for those who want all the benefits of a gas fire but don't have a built in chimney or flue in their home, a balanced flue fire comes with its own flue terminal which is vented directly through an outside wall. They are glass fronted, completely room sealed appliances and work by drawing and venting external air via a pair of co-axial tubes into the fire for combustion purposes.

Fires for every home

What type of Flavel fire will suit your home best?

From traditional to contemporary, slimline to full depth, we have models to suit all types of situation and installation. There is a Flavel fire to make anywhere feel like home.

Browse through the fire options below, then use the guide on page 6 to help you identify which type of chimney or flue you have. Every product page displays icons to identify flue suitability, fuel type, control options, and more.

Wall Inset



Rocco HE – page 8

To complement a contemporary home choose a wall inset product, otherwise known as a hole-in-the-wall fire. We have models available for all chimney and flue types.

Hearth Inset



Caress Slimline – page 51

A hearth inset fire saves space as it is recessed into the chimney breast or flue. Available in a choice of slimline or full depth fuel beds, with balanced flue options for homes without a chimney or flue.

Fireplace Suite



Sophia Fireplace Suite – page 14-15

A Suite really makes a statement in a room and comes complete with the surround and gas fire suitable for conventional as well as balanced flues.

Wall Outset



Curve – page 7

This type of fire has a direct connection to the flue and is fitted onto the wall with minimal building work required. A virtually hassle-free installation, and a perfect complement to homes requiring performance and aesthetics.

Hearth Outset



Emberglow – page 36

Set onto a hearth this type of fire takes a more prominent position in a room with some models offering the option of side windows so that the flame pattern can be seen from wider angles.

standardfires



Finesse – page 47



Windsor range – page 52-53

Standard fires can achieve a direct heat output of up to 3.1kW. It is recommended that these products are not suitable for use as a primary heat source, but are ideal if you are looking for a great fireplace feature for occasional use.

Before you begin

Type of Chimney or Flue

The type of chimney or flue you have dictates the type of fire you can have. If you're not sure, then take a look at your roof and compare it with the simple guide below. It's worth remembering that a full depth fire often requires a traditional chimney or rebate on the fire surround, whilst a slimline fire will fit virtually any chimney or flue.



Brick Chimney - Class 1 Flues

Apart from products designed for "no chimney" applications, all Flavel products will fit brick chimneys. They are easily recognisable by a chimney stack with accompanying terracotta pot or gas terminal.



Pre-Fabricated Flue - Class 2 Flues

Pre-fabricated flues are easily identifiable by a metal flue and terminal on the roof and a metal flue box behind the fire.



Pre-Cast Flue

Pre-cast flues can be identified by a ridge vent or metal flue tube and terminal on the roof. Constructed from concrete or clay blocks they form a rectangular section flue. All Flavel fires featuring this icon are only suitable for Pre-Cast flues conforming to BS EN 1858.

Controls



Manual Control

A simple and discreet control system located behind the fire's trim or fret on inset fires and the bottom right side on outsets.



Semi Remote Control

Light the fire using the manual control system then use the remote control handset to adjust the flame height and heat output.



Slide Control

Convenient control that eliminates the necessity of bending down.



Electronic Flame Control

Discreet easy access buttons are used to ignite the fire and adjust heat and flame height.



Top Control

A push down and twist ignition and control located on the top of outset fires means you don't have to bend down to light the fire.



Remote Control with Thermostat

The remote control handset can be used to light the fire as well as to adjust the flame height and heat output. Thermostatic control function can also regulate room temperature with programmable timer to ensure your room will be warm whenever you wish.



Remote Control

The remote control handset is used to light the fire as well as adjust the flame height and heat output.



Electronic Top or Side Control System

Both ignition and heat are controlled by a single rotary motion to light the fire. These easy to use controls are now available on our best selling radiant outsets. Requires an AA battery.

Can't see a Chimney or Flue?

If you can't see a chimney or flue like the ones described on the left, then you will require a Balanced Flue.



Balanced Flue

Balanced Flue fires use a horizontal pipe to vent directly outside. An electricity supply is not required for Balanced Flue products.

Gas Supply

Your gas supply will either be natural gas or LPG, depending on the area in which you live.



Natural Gas

If you have a gas meter then you will have natural gas.



LPG

LPG is the most popular alternative to natural gas.

Fuel Effect



Coal



Pebble

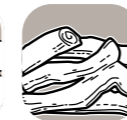

Logs



Driftwood



Decorative Flame

Interior Panels



Plain Black



Glossy Black Enamel



Ribbed Black



Brick Effect



high efficiency Conventional Flue – Wall Outset – Glass Fronted



Curve

The Curve "hang-on-the-wall" fire with its sleek lines, textured fascia and glass front, complements the unique flame pattern created by an undulating back panel. This stunning fire is easy to install as it literally hangs on the wall, rather than slotting into the structure. The Curve is perfectly suited to contemporary homes requiring state-of-the-art appearance and the performance to match.



Dimensions

A 635mm
B 870mm
C 445mm
D 166mm

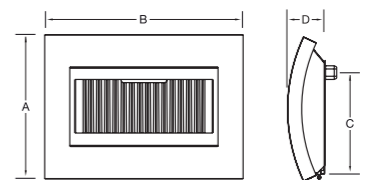

Specifications

Description: Slimline outset gas fire **Type of Heat:** Radiant & Convected

Useful energy efficiency	68.3%
Energy efficiency class	F
Fuel type	Natural gas
Direct heat output	4.0kW

Control type	Colour	Model Number
Remote	Black	FCRROORN

Safety: Flame Supervision Device & Airwatch System

Air vent required: Not normally



Rocco HE in chrome

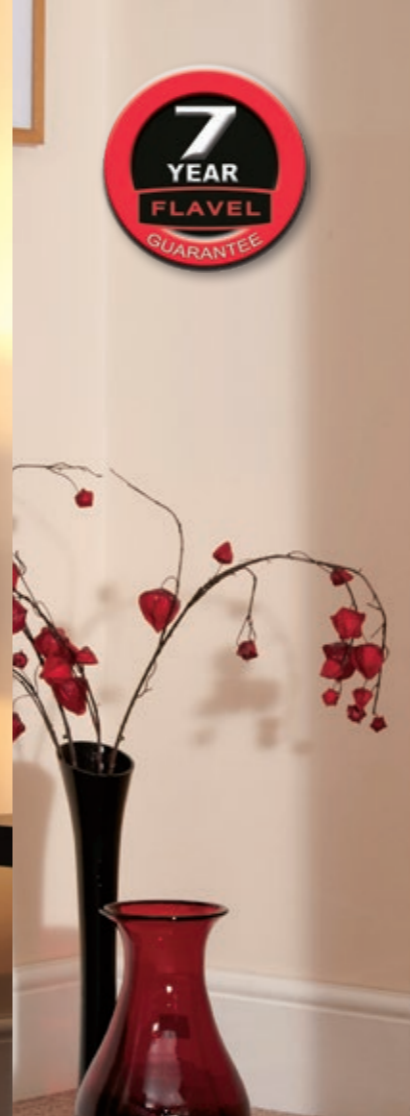

Jazz HE in black

high efficiency Conventional & Balanced Flue – Wall Inset – Glass Fronted



Rocco HE

This stunning glass fronted hole-in-the-wall fire features a realistic log fuel effect and comes in a choice of chrome or black trim options.

Specifications

Description: Full depth inset gas fire **Type of Heat:** Radiant & Convected

	Conventional	Balanced
Useful energy efficiency	73.9%	80.8%
Energy efficiency class	E	E
Fuel type	Natural gas	Natural gas
Direct heat output	3.6kW	5.5kW

Control type	Colour	Model Number	
Remote	Chrome	FPHL21RN2	FBFL21RN3
	Black	FPHL22RN2	FBFL22RN3

Safety: Flame Supervision Device & Airwatch System (not applicable to balanced flue models)

Air vent required: Not normally



Dimensions * Semi remote control, balanced flue model only.

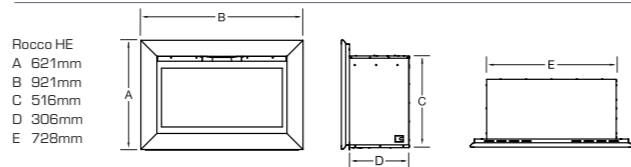

Rocco BF
A 613mm
B 910mm
C 515mm
D 350mm
E 725mm



Rocco HE with black trim

high efficiency Conventional & Balanced Flue – Wall Inset – Glass Fronted



Jazz HE

This stunning glass fronted hole-in-the-wall fire has petite dimensions and a highly realistic log fuel effect. Both the Jazz HE and balanced flue models feature a black back and high quality trims in two finishes –chrome and black.

Specifications

Description: Full depth inset gas fire **Type of Heat:** Radiant & Convected

	Conventional	Balanced
Useful energy efficiency	81.4%	83.9%
Energy efficiency class	D	D
Fuel type	Natural gas	Natural gas
Direct heat output	3.2kW	4.2kW

Control type	Colour	Model Number	
Remote	Chrome	FHCL21RN	FJBL21RN
	Black	FHCL22RN	FJBL22RN

Safety: Flame Supervision Device & Airwatch System (not applicable to balanced flue models)

Air vent required: Not normally



Dimensions * Semi remote control, balanced flue model only.

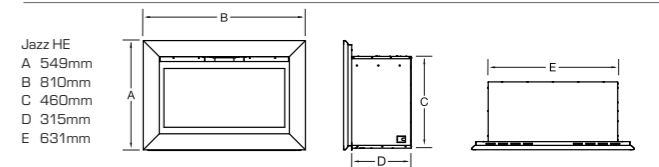

Jazz BF
A 549mm
B 810mm
C 460mm
D 295mm
E 631mm



Jazz HE with chrome trim



Diamond HE with coal fuel effect

high efficiency Conventional Flue – Wall Inset – Glass Fronted



Expression HE

The Flavel Expression HE hole in the wall high efficiency gas fire is a contemporary and economical heating solution with an energy efficiency of 84.3%. This fully glass fronted model features a stunning chrome fascia design and is operated by a fully automatic remote control system.

Specifications

Description: Full depth inset gas fire **Type of Heat:** Radiant & Convected

Useful energy efficiency	84.3%
Energy efficiency class	C
Fuel type	Natural gas
Direct heat output	3.4kW

Control type	Model Number
Remote	FHKCEHRN

Safety: Flame Supervision Device & Airwatch System

Air vent required: Not normally



Dimensions

- A 650mm
- B 500mm
- C 550mm
- D 180mm
- E 327mm
- F 365mm
- G 110mm

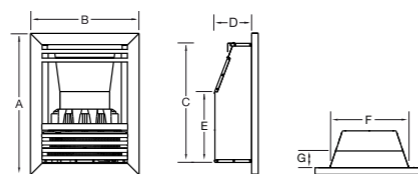

high efficiency Conventional Flue – Wall Inset – Glass Fronted



Diamond HE

As Flavel's debut high efficiency hole-in-the-wall fire, the Diamond HE is a contemporary and economical heating solution with an energy efficiency of 84.3%. This glass fronted fire features the stunning chrome and black 'Diamond' fascia design and is available with a choice of coal or pebble fuel effect.

Specifications

Description: Full depth inset gas fire **Type of Heat:** Radiant & Convected

Useful energy efficiency	84.3%
Energy efficiency class	C
Fuel type	Natural gas
Direct heat output	3.4kW

Fuel effect	Control type	Model Number
Coal	Remote	FHDCOORN3
Pebble		FHDPOORN3

Safety: Flame Supervision Device & Airwatch System

Air vent required: Not normally

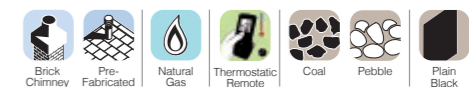

Dimensions

- A 650mm
- B 600mm
- C 550mm
- D 180mm
- E 365mm
- F 65mm

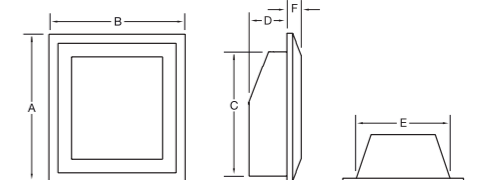

Diamond HE with pebble fuel effect



Windsor Contemporary HE with pebble fuel effect



Windsor Contemporary Plus with coal fuel effect

high efficiency Conventional Flue – Wall Inset – Glass Fronted



Windsor Contemporary HE

The Windsor Contemporary glass fronted high efficiency wall inset gas fire comes with the option of a coal or pebble fuel bed and features a large viewing window and chrome fascia. This extremely versatile fire will fit into almost any chimney or flue.

Specifications

Description: Slimline inset gas fire **Type of Heat:** Radiant & Convected

Useful energy efficiency	81.3%
Energy efficiency class	D
Fuel type	Natural gas
Direct heat output	2.9kW

Fuel effect	Control type	Model Number
Coal	Manual	FSHCHWMN
Pebble		FSHPHWMN

Safety: Flame Supervision Device & Airwatch System

Air vent required: Not normally



Dimensions

- A 671mm
- B 512mm
- C 550mm
- D 125mm
- E 327mm

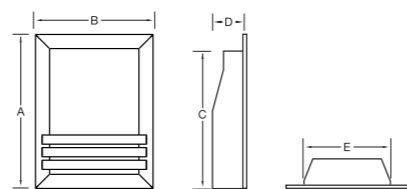

Windsor Contemporary HE with coal fuel effect

high efficiency Conventional Flue – Wall Inset – Open Fronted



Windsor Contemporary Plus

The Windsor Contemporary wall inset gas fire is also available as an open fronted model featuring a large viewing window and chrome fascia. There is a choice of a coal or pebble fuel bed and this very versatile fire will fit into almost any chimney or flue.

Specifications

Description: Slimline inset gas fire **Type of Heat:** Radiant & Convected

Useful energy efficiency	66.8%
Energy efficiency class	F
Fuel type	Natural gas
Direct heat output	4.0kW

Fuel effect	Control type	Model Number
Coal	Manual	FSPCHWMN
Pebble		FSPPHWMN

Safety: Flame Supervision Device & Airwatch System

Air vent required: Not normally



Dimensions

- A 671mm
- B 512mm
- C 550mm
- D 125mm
- E 327mm

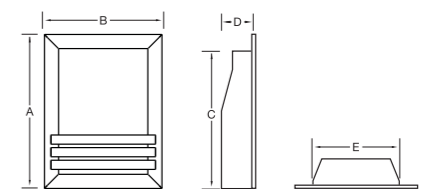

Windsor Contemporary Plus with pebble fuel effect

Sophia Suite

The Sophia suite features a large high efficiency gas fire, and is framed with a beautifully designed Royal Botticino marble surround. This suite benefits from a non reflective glass front, that delivers an uninterrupted view of the log fuel effect.

This suite is available in a conventional flue or slimline balanced flue version, and is operated by a multifunctional remote control handset. The remote control system includes a thermostatic operation which automatically adjusts the heat output up or down to maintain your desired pre-set temperature. There is also a wake/sleep timer function which lets you specify when the fire will automatically turn on and turn off.

For optimum efficiency the Sophia comes with a built in electronic fan that is used to circulate convected heat around the room.



Sophia Slimline balanced flue

Specifications

Description: Full depth fireplace suite Type of Heat: Radiant & Convected

	Conventional	Balanced
Useful energy efficiency	82%	87.2%
Energy efficiency class	D	C
Fuel type	Natural gas	Natural gas
Direct heat output	5.6kW	4.3kW

Control type	Model Number
Remote	FDCLBRN2+B-163230 FSBLBTRN+B-179830

Safety: Flame Supervision Device & Airwatch System (not applicable to balanced flue models)

Air vent required: Not normally

Dimensions

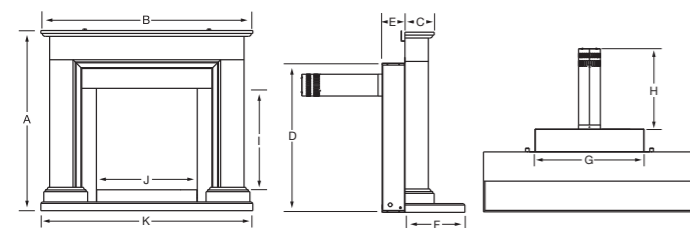

Balanced Flue			
A	1232mm	I	694mm
B	1450mm	J	960mm
C	200mm	G	746mm
D	1020mm	H	550mm

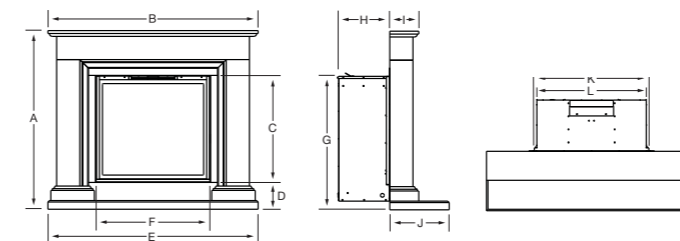

Conventional Flue			
A	1233mm	E	1450mm
B	1480mm	F	793mm
C	739mm	G	921mm
D	185mm	H	352mm
		I	200mm
		J	410mm
		K	727mm
		L	727mm

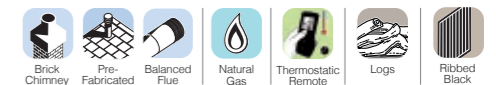

Sophia Suite conventional flue

Romance

Romance is an exceptionally stylish and impressive natural log fuel effect gas fire.

This glass fronted fire is available in two control options, remote, or manual, both delivering an exceptional heat output of 4.0kW, with a high efficiency rating upto 82.6%. The Romance is designed with a large clear glass window to provide wide-angle views of the lively full depth log burning fuel effect.

This stunning gas fire is further complemented with a choice of uniquely designed fascias, and are available in Black Nickel & Black, Black Nickel & Chrome, and Satin Silver & Chrome.



Romance
Black Nickel & Chrome



Romance
Satin Silver & Chrome

Specifications

Description: Full depth inset gas fire **Type of Heat:** Radiant & Convected

Useful energy efficiency	Remote 82.6%	Manual 82.3%
Energy efficiency class	C	D
Fuel type	Natural gas	
Direct heat output	4.0kW	

Colour	Model Number	Model Number
Black Nickel & Chrome	FLBLBCRN	FLBLBCM
Black Nickel & Black	FLBLNBRN	FLBLNBM
Satin Silver & Chrome	FLBLSCRN	FLBLSCM

Safety: Flame Supervision Device & Airwatch System

Air vent required: Not normally

Dimensions

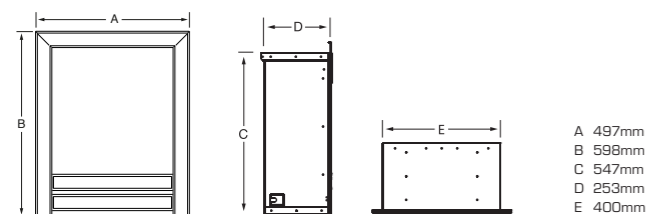

Black Nickel & Black

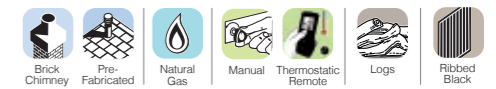



Caress HE Traditional in brass



Decadence HE in chrome

high efficiency Conventional Flue – Hearth Inset – Glass Fronted



Caress HE

The Caress HE glass fronted gas fire features an authentic looking coal fuel effect, and stylish trim and fret in a choice of Traditional or Contemporary styling in solid cast brass or chrome cast iron. It features a heat output of up to 4kW and an energy efficiency of up to 86.3%.

Each model is available in a range of control options and there is an LPG model for homes without a natural gas supply.

Specifications

Description: Full depth inset gas fire **Type of Heat:** Radiant & Convected

Useful energy efficiency	86%	86.3%
Energy efficiency class	C	C
Fuel type	Natural gas	LPG
Direct heat output	3.9kW	4.0kW

Control type	Colour	Contemporary	Traditional	Contemporary	Traditional
		Model Number			
Manual	Brass		FHEC11MN		
	Brass	FHEC45SN	FHEC41SN		FHEC11SP
Slide	Chrome	FHEC6RSN	FHEC6JSN	FHEC3RSP	
	Brass		FHEC11RN2		
Remote	Brass				
	Chrome	FHEC3RRN2			

Safety: Flame Supervision Device & Airwatch System
Air vent required: Not normally

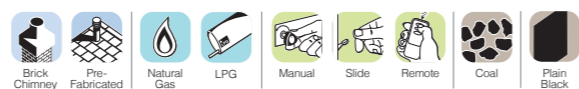

Dimensions

- A 615mm
- B 510mm
- C 550mm
- D 230mm
- E 400mm

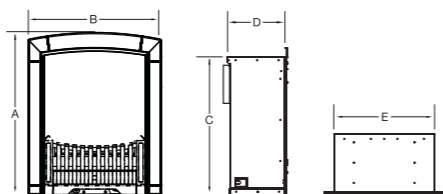

Caress HE Contemporary in chrome

high efficiency Conventional Flue – Hearth Inset – Glass Fronted



Decadence HE & Decadence Slimline HE

The Decadence HE high efficiency glass fronted gas fire with an energy efficiency of 84.3%. It is available in a choice three beautiful high quality cast iron fascias - gold, chrome or black nickel plated finishes. The Decadence HE Slimline model is also highly efficient and both models will fit almost any chimney or flue, including pre-cast (BS EN 1858). Both models are available in a choice of control model and feature a coal effect fuel bed.

Specifications

Description: Full depth inset gas fire/slimline inset gas fire
Type of Heat: Radiant & Convected

	HE Manual	HE Remote	Slimline HE Manual
Useful energy efficiency	84.3%	84.3%	81.3%
Energy efficiency class	D	C	D
Fuel type	Natural gas	Natural gas	Natural gas
Direct heat output	3.4kW	3.4kW	2.9kW

Colour	Model Number		
Gold	FHKCDBMN2	FHKCDBRN3	FSHCDBMN
Chrome	FHKCDCMN2	FHKCDCRN3	FSHCDCMN
Black Nickel	FHKCDNMN2	FHKCDNRN3	FSHCDNMN

Safety: Flame Supervision Device & Airwatch System
Air vent required: Not normally



Dimensions

- HE
- A 631mm
- B 529mm
- C 550mm
- D 180mm
- E 365mm

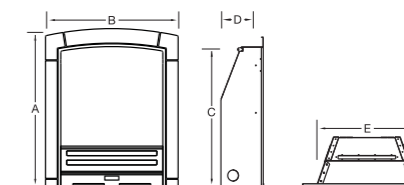

- Slimline HE
- A 631mm
- B 529mm
- C 550mm
- D 125mm
- E 327mm

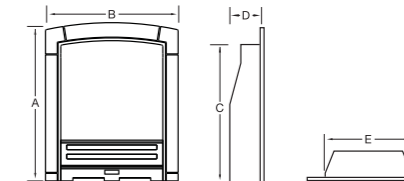

Decadence Slimline HE in gold



Decadence Slimline HE in black nickel



Kenilworth HE in black



Linear HE with coal fuel effect

high efficiency Conventional Flue – Hearth Inset – Glass Fronted



Kenilworth HE

The Kenilworth gas fire features a welcoming full depth coal fuel effect and will fit most chimney and flue types including a pre-cast flue with a 3" rebate on the fire surround.

Specifications

Description: Full depth inset gas fire **Type of Heat:** Radiant & Convected

	Manual	Remote
Useful energy efficiency	84.3%	84.3%
Energy efficiency class	D	C
Fuel type	Natural gas	Natural gas
Direct heat output	3.4kW	3.4kW

Colour	Model Number	
Brass	FHKC14MN2	FHKC14RN3
Black	FHKC26MN2	FHKC26RN3
Chrome	FHKC37MN2	FHKC37RN3

Safety: Flame Supervision Device & Airwatch System

Air vent required: Not normally



Dimensions

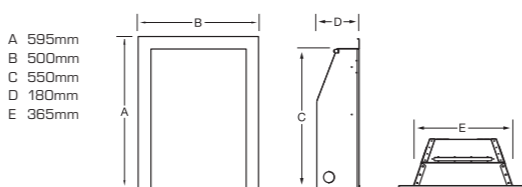

Kenilworth HE in brass



Kenilworth HE in chrome

high efficiency Conventional Flue – Hearth Inset – Glass Fronted



Linear HE

The Linear is a stunning modern design with the combination of black ribbed back panels and chrome fascia. This full depth gas fire delivers a wonderful flickering glow and can be installed into almost any chimney or flue including a pre-cast flue with a 3" rebated surround.

Specifications

Description: Full depth inset gas fire **Type of Heat:** Radiant & Convected

Useful energy efficiency	84.3%
Energy efficiency class	D
Fuel type	Natural gas
Direct heat output	3.4kW

Fuel effect	Control type	Colour	Model Number
Coal	Manual	Chrome	FHLCXOMN2
Pebble			FHLPXOMN2

Safety: Flame Supervision Device & Airwatch System

Air vent required: Not normally



Dimensions

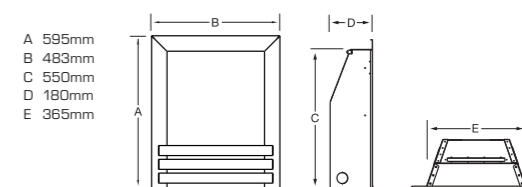

Linear HE with pebble fuel effect



Windsor Contemporary HE in chrome with pebble fuel effect



Windsor Traditional HE in brass

high efficiency Conventional Flue – Hearth Inset – Glass Fronted



Windsor Contemporary HE

Stunning styling makes the Windsor Contemporary glass fronted high efficiency gas fire the centrepiece of your room. This slimline model will fit almost any chimney or flue, including pre-cast (BS EN 1858), and comes in a chrome fascia.

Specifications

Description: Slimline inset gas fire **Type of Heat:** Radiant & Convected

Useful energy efficiency	81.3%
Energy efficiency class	D
Fuel type	Natural gas
Direct heat output	2.9kW

Fuel effect	Control type	Colour	Model Number
Coal	Manual	Chrome	FSHCUOMN
		Brass	FSHCU1MN
Pebble		Chrome	FSHPUOMN

Safety: Flame Supervision Device & Airwatch System

Air vent required: Not normally



Dimensions

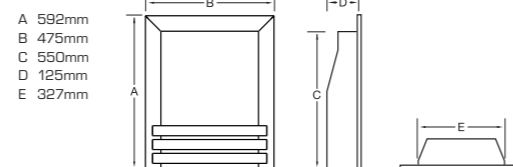

Windsor Contemporary HE in brass with coal fuel effect

high efficiency Conventional Flue – Hearth Inset – Glass Fronted



Windsor Traditional HE

The Windsor Traditional HE glass fronted gas fire offers exceptional heat output of 2.9kW with an energy efficiency of 81.3% and is available in manual or slide control.

Specifications

Description: Slimline inset gas fire **Type of Heat:** Radiant & Convected

Useful energy efficiency	81.3%
Energy efficiency class	D
Fuel type	Natural gas
Direct heat output	2.9kW

Control type	Colour	Model Number
Manual	Brass	FSHC11MN
	Chrome	FSHC3JMN
Slide	Brass	FSHC11SN2
	Chrome	FSHC3JSN2

Safety: Flame Supervision Device & Airwatch System

Air vent required: Not normally



Dimensions

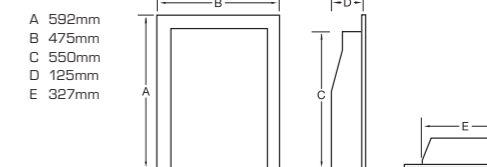

Windsor Traditional HE in Chrome



Richmond Plus in brass



Caress Contemporary in chrome

high efficiency Conventional Flue – Hearth Inset – Open Fronted



Richmond Plus & Richmond

You can now achieve the look of a real open coal fire, combined with the convenience of gas fuel. The Richmond full depth convector fire combines a brilliant flame effect with high efficiency and outstanding warmth. The Richmond features a Standard trim and Dallas fret and is available in black, chrome or brass finishes.

Specifications

Description: Full depth inset gas fire **Type of Heat:** Radiant & Convected

Richmond Plus

Useful energy efficiency	66.7%
Energy efficiency class	F
Fuel type	Natural gas
Direct heat output	4.1kW

Richmond

Useful energy efficiency	60%
Energy efficiency class	F
Fuel type	Natural gas
Direct heat output	3.7kW

Colour	Model Number		
	Manual	Slide	Remote
Brass	FOPC12MN	FOPC12SN	FOPC12RN2
Black	FOPC23MN	FOPC23SN	FOPC23RN2
Chrome	FOPC37MN	FOPC37SN	FOPC37RN2

Colour	Model Number	
	Manual	Slide
Brass	FICC12MN	FICC42SN
Black	FICC23MN	FICC53SN
Chrome	FICC37MN	FICC37SN

Safety: Flame Supervision Device & Airwatch System
Air vent required: Not normally

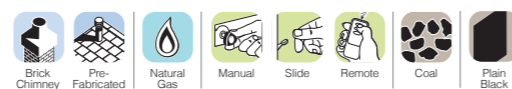

Dimensions

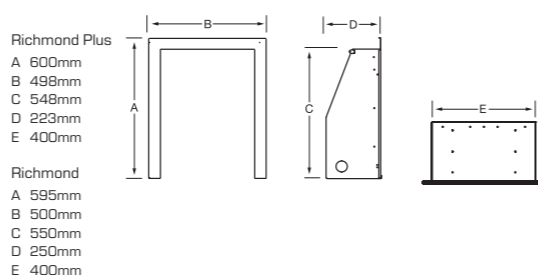

Richmond Plus in chrome



Richmond in black

high efficiency Conventional Flue – Hearth Inset – Open Fronted



Caress Plus & Caress

The Caress Plus and Caress feature an authentic looking coal fuel effect, and stylish trim and fret in a choice of Traditional or Contemporary styling in solid cast brass or chrome. The Caress Plus open-fronted model has been designed to provide an energy efficiency of 68.3% and a heat output at 4.2kW. Each model is available in a range of control options.

Specifications

Description: Mid and full depth inset gas fire **Type of Heat:** Radiant & Convected

Caress Plus

Useful energy efficiency	68.3%
Energy efficiency class	F
Fuel type	Natural gas
Direct heat output	4.2kW

Caress

Useful energy efficiency	60%
Energy efficiency class	F
Fuel type	Natural gas
Direct heat output	3.7kW

Control	Colour	Model Number	
		Contemporary	Traditional
Manual	Brass	FKPC11MN	FKPC11RN2
	Chrome	FKPC3RMN	FKPC41SN
Slide	Brass	FKPC45SN	FKPC6JSN
	Chrome	FKPC6RSN	FKPC6JSN
Remote	Brass	FKPC11RN2	
	Chrome	FKPC3RRN2	

Safety: Flame Supervision Device & Airwatch System
Air vent required: Not normally

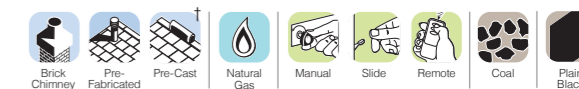

Dimensions

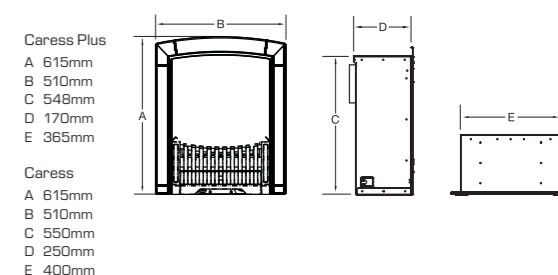

Caress Plus Traditional in brass



Calypso Plus in brass



Rhapsody Plus in chrome

high efficiency Conventional Flue – Hearth Inset – Open Fronted



Calypso Plus & Calypso

The Calypso successfully combines exceptional fire design with today's necessity for convenience in the form of a user friendly dual directional slide control. This fire will be equally at home in a contemporary or traditional fire surround and room setting.

Specifications

Description: Full depth inset gas fire **Type of Heat:** Radiant & Convected

Calypso Plus

Useful energy efficiency	68.3%	67%
Energy efficiency class	F	F
Fuel type	Natural gas	LPG
Direct heat output	4.2kW	4.2kW

Calypso

Useful energy efficiency	60%
Energy efficiency class	F
Fuel type	Natural gas
Direct heat output	3.7kW

Control	Colour	Model Number
Slide	Brass	FKPC42SN FKPC42SP

Control	Colour	Model Number
Slide	Brass	FNCN42SN

Safety: Flame Supervision Device & Airwatch System
Air vent required: Not normally



Dimensions †Pre-cast flue on Calypso Plus models.

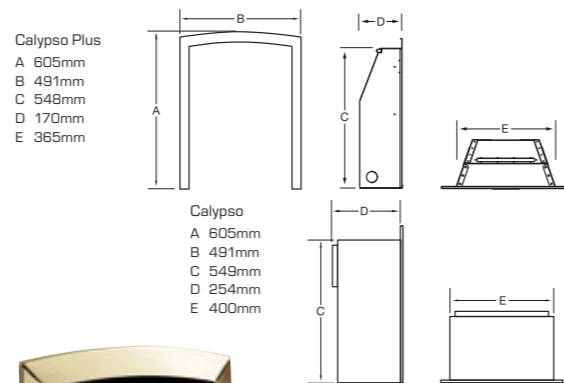

Calypso in brass

high efficiency Conventional Flue – Hearth Inset – Open Fronted



Rhapsody Plus & Rhapsody

The classic Rhapsody Plus and Rhapsody open fronted fires have a very realistic deep fuel effect and beautiful flame picture making them indistinguishable from a real coal fire. With an elegant arched trim and striking fret they are a timeless classic.

Specifications

Description: Slimline inset gas fire/full depth inset gas fire **Type of Heat:** Radiant & Convected

Rhapsody Plus

Useful energy efficiency	68.3%	67%
Energy efficiency class	F	F
Fuel type	Natural gas	LPG
Direct heat output	4.2kW	4.2kW

Rhapsody

Useful energy efficiency	60%
Energy efficiency class	F
Fuel type	Natural gas
Direct heat output	3.7kW

Control	Colour	Model Number
Slide	Brass	FKPCBRSN FKPCBRSP
	Antique Brass	FKPCBBSN FKPCBBSP
	Black	FKPCBLSN FKPCBLSP
	Chrome	FKPCLSN FKPCLSLP

Control	Colour	Model Number
Slide	Brass	FDCN45SN
	Antique Brass	FDCN46SN
	Black	FDCN57SN
	Chrome	FDCN68SN

Safety: Flame Supervision Device & Airwatch System
Air vent required: Not normally



Dimensions †Pre-cast flue on Rhapsody Plus models.

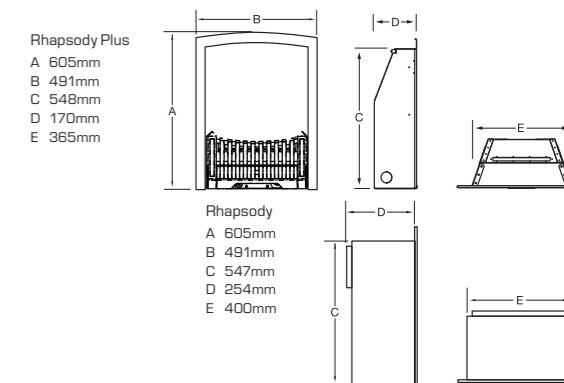

Rhapsody Plus in antique brass

Rhapsody Plus in brass

Rhapsody in black



Decadence Plus in black nickel



Linear Plus with pebble fuel effect

high efficiency Conventional Flue – Hearth Inset – Open Fronted



Decadence Plus

The Decadence Plus is a striking open fronted coal effect gas fire which features a choice of three beautiful high quality cast iron fascias available in a choice of gold, chrome or black nickel plated finishes.

Specifications

Description: Mid depth inset gas fire **Type of Heat:** Radiant & Convected

Useful energy efficiency	68.3%
Energy efficiency class	F
Fuel type	Natural gas
Direct heat output	4.2kW

Control type	Colour	Model Number
Manual	Gold	FKPCDBMN
	Chrome	FKPCDCMN
	Black Nickel	FKPCDNMN
Slide	Gold	FKPCDBSN
	Chrome	FKPCDCSN
	Black Nickel	FKPCDNSN
Remote	Gold	FKPCDBRN2
	Chrome	FKPCDCRN2
	Black Nickel	FKPCDNRN2

Safety: Flame Supervision Device & Airwatch System
Air vent required: Not normally

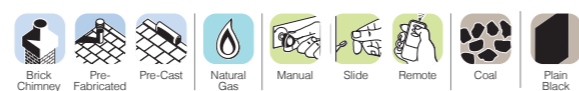

Dimensions

- A 631mm
- B 529mm
- C 550mm
- D 170mm
- E 365mm

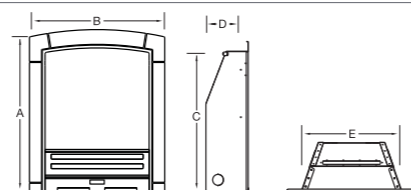

Decadence Plus in gold



Decadence Plus in chrome

high efficiency Conventional Flue – Hearth Inset – Open Fronted



Linear Plus

The Linear is a stunning modern design with the combination of black ribbed back panels and chrome fascia. This deep fuelbed gas fire delivers a wonderful flame effect and can be installed into almost any chimney or flue including a pre-cast flue with a 3" rebated surround.

Specifications

Description: Mid depth inset gas fire **Type of Heat:** Radiant & Convected

Useful energy efficiency	68.3%
Energy efficiency class	F
Fuel type	Natural gas
Direct heat output	4.2kW

Fuel Effect	Control type	Colour	Model Number
Coal	Manual	Chrome	FKPCUOMN
Pebble			FKPPUOMN

Safety: Flame Supervision Device & Airwatch System
Air vent required: Not normally



Dimensions

- A 595mm
- B 483mm
- C 548mm
- D 170mm
- E 365mm

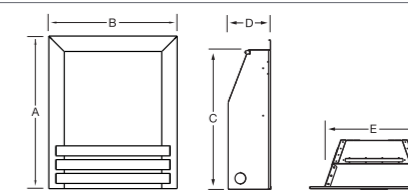

Linear Plus with coal fuel effect



Kenilworth Plus in brass with Blenheim fret



high efficiency Conventional Flue – Hearth Inset – Open Fronted



Kenilworth Plus

The Kenilworth gas fire features a welcoming deep coal fuel effect that will fit most chimney and flue types including a pre-cast flue with a 3" rebate on the fire surround.

Specifications

Description: Mid depth inset gas fire **Type of Heat:** Radiant & Convected

Useful energy efficiency	68.3%
Energy efficiency class	F
Fuel type	Natural gas
Direct heat output	4.2kW

Control type	Colour	Model Number
Manual	Brass	FKPC14MN
	Chrome (Grace)	FKPC37MN
	Black	FKPC26MN
Slide	Brass	FKPC14SN
	Chrome (Grace)	FKPC37SN
	Black	FKPC26SN
Remote	Brass	FKPC14RN2
	Chrome (Grace)	FKPC37RN2
	Black	FKPC26RN2

Safety: Flame Supervision Device & Airwatch System
Air vent required: Not normally

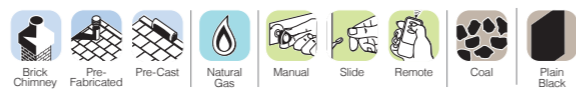

Dimensions

- A 595mm
- B 500mm
- C 548mm
- D 170mm
- E 365mm

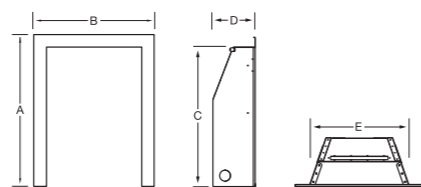

Kenilworth Plus in black with Blenheim fret



Kenilworth Plus in chrome with Grace fret

high efficiency Conventional Flue – Hearth Inset – Open Fronted



Expression Plus

The Flavel Expression Plus high efficiency gas fire boasts an impressive 68.3% Energy efficiency and can be installed in to almost any chimney or flue, including pre-cast when fitted with a 3" rebated fire surround. This open-fronted gas fire features a coal fuel effect and comes with a contemporary chrome one-piece fascia. This fire is available with manual control, slide control, or fully automatic remote control.

Specifications

Description: Mid depth inset gas fire **Type of Heat:** Radiant & Convected

Useful energy efficiency	68.3%
Energy efficiency class	F
Fuel type	Natural gas
Direct heat output	4.2kW

Control type	Colour	Model Number
Manual	Chrome	FKPCEPMN
Slide	Chrome	FKPCEPSN
Remote	Chrome	FKPCEPRN2

Safety: Flame Supervision Device & Airwatch System
Air vent required: Not normally

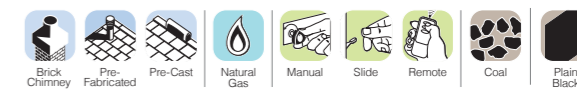

Dimensions

- A 599mm
- B 500mm
- C 550mm
- D 170mm
- E 365mm

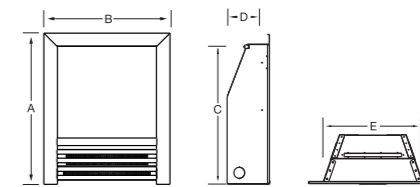



Windsor Contemporary Plus in satin silver with pebble fuel effect



high efficiency Conventional Flue – Hearth Inset – Open Fronted



Windsor Contemporary Plus

Stunning styling makes the Windsor Contemporary Plus the centrepiece of your room. This slimline gas fire will fit almost any chimney or flue, including pre-cast (BS EN 1858) and achieves an impressive 66.8% energy efficiency with a 4.0kW heat output.

Specifications

Description: Slimline inset gas fire **Type of Heat:** Radiant & Convected

Useful energy efficiency	66.8%
Energy efficiency class	F
Fuel type	Natural gas
Direct heat output	4.0kW

Fuel Effect	Control type	Colour	Model Number
Coal	Manual	Chrome	FSPCUOMN
Pebble		Chrome	FSPPUOMN
		Satin Silver	FSPPBOMN

Safety: Flame Supervision Device & Airwatch System

Air vent required: Not normally



Dimensions

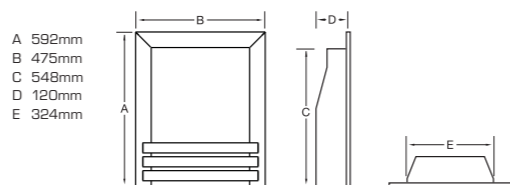

Windsor Contemporary Plus in chrome with coal fuel effect

high efficiency Conventional Flue – Hearth Inset – Open Fronted



Windsor Traditional Plus

The Windsor Traditional Plus is an open fronted high efficiency gas fire combining an exceptional heat output of 4.0kW and an energy efficiency of 66.8%. This fire is perfect for homes where a more traditional styling is needed to complement the décor.

Specifications

Description: Slimline inset gas fire **Type of Heat:** Radiant & Convected

Useful energy efficiency	66.8%
Energy efficiency class	F
Fuel type	Natural gas
Direct heat output	4.0kW

Control type	Colour	Model Number
Manual	Brass	FSPC11MN

Safety: Flame Supervision Device & Airwatch System

Air vent required: Not normally



Dimensions

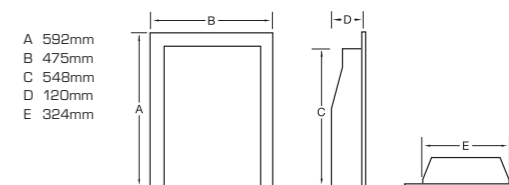



Stirling Plus

The Stirling Plus open fronted high efficiency slimline gas fire will fit into all flue types and, with a very impressive heat output of 4.0kW, is sure to be a popular choice. The Stirling Plus is operated by a choice of manual or slide control and is available in either a black or brass finish.



Stirling Plus with brass trim and Dallas antique brass fret



Specifications

Description: Slimline inset gas fire **Type of Heat:** Radiant & Convected

Useful energy efficiency	66.8%
Energy efficiency class	F
Fuel type	Natural gas
Direct heat output	4.0kW

Control type	Colour	Model Number
Manual	Brass	FSPC12MN
	Black	FSPC23MN
Slide	Brass	FSPC12SN
	Black	FSPC23SN

Safety: Flame Supervision Device & Airwatch System

Air vent required: Not normally

Dimensions

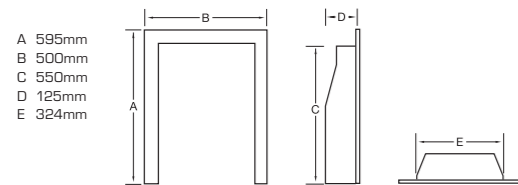



high efficiency Conventional & Balanced Flue – Hearth Outset – Glass Fronted



Emberglow

The Emberglow high efficiency outset gas fire features an elegant design with high quality cast iron canopy and fire front. With front and side windows the mesmerising dancing flames can be seen from all angles and it is operated by an easy to use electronic side control system. The main image represents the natural gas model. The flame picture may differ on LPG model.

Specifications

Description: Full depth outset gas fire **Type of Heat:** Radiant & Convected

	ES	Remote	ES	Manual
Useful energy efficiency	78.7%	81.6%	82.2%	86.9%
Energy efficiency class	E	D	D	C
Fuel type	Natural gas		LPG	Natural gas
Direct heat output	4.2kW	4.4kW	4.2kW	4.3kW
Model Number				
	FEMCO0EN	FEMCOORN2	FEMCO0EP	FEBCO0MN

Safety: Flame Supervision Device & Airwatch System (not applicable to balanced flue model)
Air vent required: Not normally

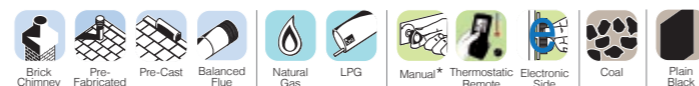

Dimensions

* Manual control Balanced Flue model.

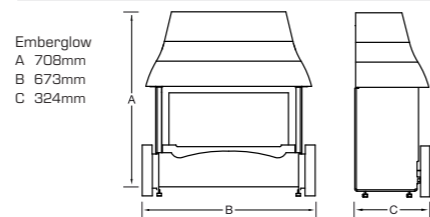

Emberglow
 A 708mm
 B 673mm
 C 324mm

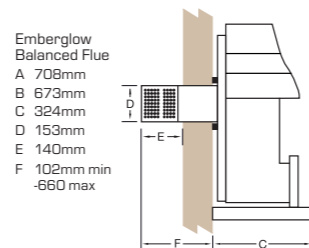

Emberglow
 Balanced Flue
 A 708mm
 B 673mm
 C 324mm
 D 153mm
 E 140mm
 F 102mm min
 -660 max



Emberglow Balanced Flue

high efficiency Conventional Flue – Hearth Outset – Glass Fronted



Renoir

The Renoir outset living flame effect gas fire features a beautiful flickering flame effect and is operated by an electronic side control system to make it much easier to ignite the fire. This classically designed fire has an impressive heat output of up to 4.4kW and energy efficiency of up to 81.6%.

Specifications

Description: Full depth outset gas fire **Type of Heat:** Radiant & Convected

	ES	Remote
Useful energy efficiency	78.7%	81.6%
Energy efficiency class	E	D
Fuel type	Natural gas	Natural gas
Direct heat output	4.2kW	4.4kW

Colour	Model Number	
Black	FRECNOEN	FRECORN2
Bronze	FRECROEN	FRECORN2

Safety: Flame Supervision Device & Airwatch System
Air vent required: Not normally

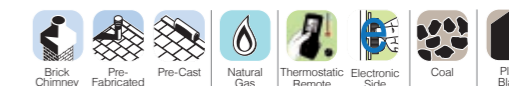

Dimensions

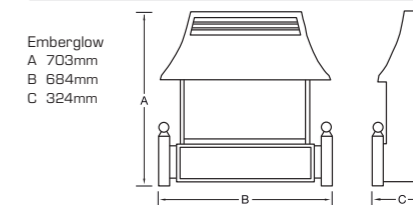

Emberglow
 A 703mm
 B 684mm
 C 324mm



Renoir in bronze



Regent in black



Welcome in bronze

high efficiency Conventional Flue – Hearth Outset – Open Fronted



Regent

One of the most popular radiant fires in the UK, the Regent features a slim design and has an energy efficiency of 74%. The Regent is available in a choice of black or bronze finishes and is operated by electronic side control.

Specifications

Description: Full depth outset gas fire **Type of Heat:** Radiant & Convected

Useful energy efficiency	74%
Energy efficiency class	E
Fuel type	Natural gas
Direct heat output	4.5kW

Control type	Colour	Model Number
Electronic Side	Black	FRGCNOEN
	Bronze	FRGCPOEN

Safety: Flame Supervision Device & Airwatch System

Air vent required: Not normally



Dimensions

A 680mm
B 710mm
C 255mm

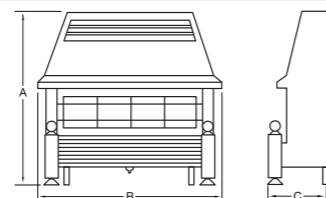

Regent in bronze

high efficiency Conventional Flue – Hearth Outset – Open Fronted



Welcome

The Welcome's beautiful electrically illuminated coal effect brings life to the room even when the heat is off, providing a charming focal point to any room. It also has a 74% energy efficiency, resulting in lower running costs.

Specifications

Description: Full depth outset gas fire **Type of Heat:** Radiant & Convected

Useful energy efficiency	74%
Energy efficiency class	E
Fuel type	Natural gas
Direct heat output	4.5kW

Control type	Colour	Model Number
Electronic Side	Black	FWERNOEN
	Bronze	FWERROEN

Safety: Flame Supervision Device & Airwatch System

Air vent required: Not normally



Dimensions

A 680mm
B 718mm
C 310mm

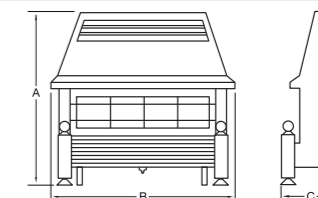

Welcome in black



Strata in brown



Misermatic in light oak

high efficiency Conventional Flue – Hearth Outset – Open Fronted



Strata

The Strata offers an incredible energy efficiency of 82% and 5.2kW heat output. It has a stylish contemporary look with soft, curved lines and is available in a choice of three colour options. Can be wall mounted.

Specifications

Description: Slimline outset gas fire **Type of Heat:** Radiant & Convected

Useful energy efficiency	82%
Energy efficiency class	D
Fuel type	Natural gas
Direct heat output	5.2kW

Control type	Colour	Model Number
Electronic Top	Black	FORSBLEN
	Brown	FORSBOEN
	Cream	FORSOEN

Safety: Flame Supervision Device & Airwatch System

Air vent required: Not normally



Dimensions

- A 530mm
- B 715mm
- C 210mm
- D 100mm
- E 60mm

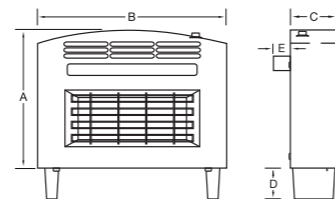

Strata in black

Strata in cream

high efficiency Conventional Flue – Hearth Outset – Open Fronted



Misermatic

Incredible 82% energy efficiency and adaptability; the Misermatic has them both. Available in a range of wood finishes, this fire can be wall or hearth mounted with an easily accessible top mounted control. Can be wall mounted.

Specifications

Description: Slimline outset gas fire **Type of Heat:** Radiant & Convected

Useful energy efficiency	82%
Energy efficiency class	D
Fuel type	Natural gas
Direct heat output	5.2kW

Control type	Colour	Model Number
Electronic Top	Mahogany	FORMMOEN
	Teak	FORMTOEN
	Light Oak	FORMLOEN
Electronic Top	Medium Oak	FORMNOEN
	Black	FORMBOEN

Safety: Flame Supervision Device & Airwatch System

Air vent required: Not normally

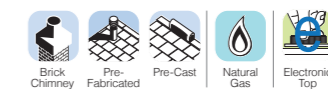

Dimensions

- A 515mm
- B 800mm
- C 200mm
- D 100mm
- E 60mm

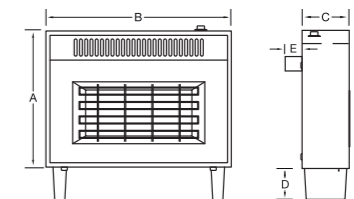

Misermatic in teak

Misermatic in medium oak

Misermatic in mahogany

Misermatic in black



Renaissance in silver



Firenza in bronze

high efficiency Conventional Flue – Hearth Outset – Open Fronted



Renaissance

The Renaissance provides a natural talking point the moment you enter the room. Its stylish retro design is matched by its forward thinking simplicity of installation, impressive 5.2kW heat output and astounding 82% energy efficiency. Can be wall mounted.

Specifications

Description: Slimline outset gas fire **Type of Heat:** Radiant & Convected

Useful energy efficiency	82%
Energy efficiency class	D
Fuel type	Natural gas
Direct heat output	5.2kW

Control type	Colour	Model Number
Electronic Top	Silver	FORRSOEN
	Black	FORRBOEN

Safety: Flame Supervision Device & Airwatch System

Air vent required: Not normally



Dimensions

- A 652mm
- B 730mm
- C 200mm
- D 37mm
- E 60mm

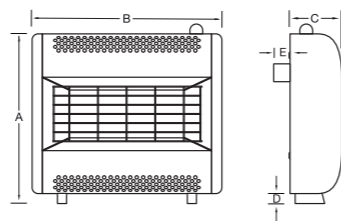

Renaissance in black

high efficiency Conventional Flue – Hearth Outset – Open Fronted



Firenza

The compact and economical Firenza can be wall or hearth mounted and has an energy efficiency of 80.1%. The control handle is located on the top panel for ease of use.

Specifications

Description: Slimline outset gas fire **Type of Heat:** Radiant & Convected

Useful energy efficiency	80.1%
Energy efficiency class	D
Fuel type	Natural gas
Direct heat output	3.8kW

Control type	Colour	Model Number
Top	Black	FFRZ1MN
	Bronze	FFRROMN

Safety: Flame Supervision Device & Airwatch System

Air vent required: Not normally



Dimensions

- A 658mm
- B 506mm
- C 222mm

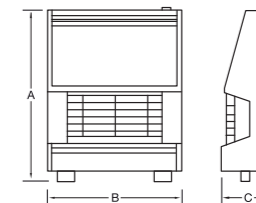

Firenza in black



Calibre BF in brass



Raglan BF in satin silver trim & antique silver fret

high efficiency Balanced Flue – Hearth Inset – Glass Fronted



Calibre BF

The Calibre Balanced Flue gas fire boasts an energy efficiency of 93.5% and features a full depth coal fuel effect. This glass fronted fire has an exceptionally large viewing area and is available in a choice of brass or chrome. The main image represents the Calibre natural gas model. The flame picture may differ on LPG model.

Specifications

Description: Full depth inset gas fire **Type of Heat:** Radiant & Convected

Useful energy efficiency	93.5%	93.5%
Energy efficiency class	B	B
Fuel type	Natural gas	LPG
Direct heat output	3.9kW	4.0kW

Fuel effect	Control type	Colour	Model Number
Coal	Manual	Brass	FBFC1SMN2
		Chrome	FBFC37MN2
	EFC	Brass	FBFC1SEN3
		Chrome	FBFC37EN3
	Remote	Brass	FBFC1SRN3
		Chrome	FBFC37RN3

Safety: Flame Supervision Device
Air vent required: Not normally

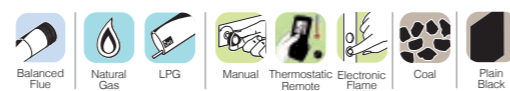

Dimensions

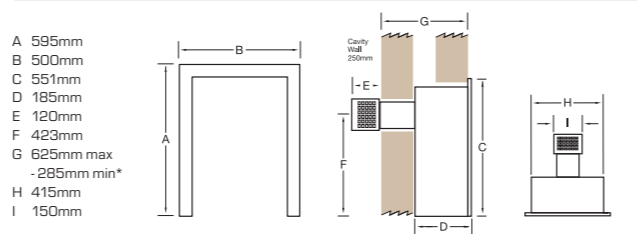

*Differs on EFC models. An optional flue extension is available to increase maximum length to 1015mm or manual and 973mm on EFC models.



Calibre BF in chrome

high efficiency Balanced Flue – Hearth Inset – Glass Fronted



Raglan BF

With an energy efficiency of 80% the stylish Raglan Balanced Flue is designed to fit into houses without a chimney or flue and its glass front does more than simply look great, it increases efficiency too.

Specifications

Description: Slimline inset gas fire **Type of Heat:** Radiant & Convected

Useful energy efficiency	80%
Energy efficiency class	E
Fuel type	Natural gas
Direct heat output	2.7kW

Control type	Colour	Model Number
Manual	Satin Silver	FBFC3JMN
	Brass	FBFC12MN

Safety: Flame Supervision Device
Air vent required: Not normally



Dimensions

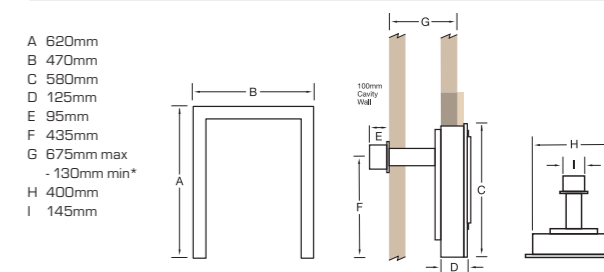

Raglan BF in brass



Orchestra BF in satin silver

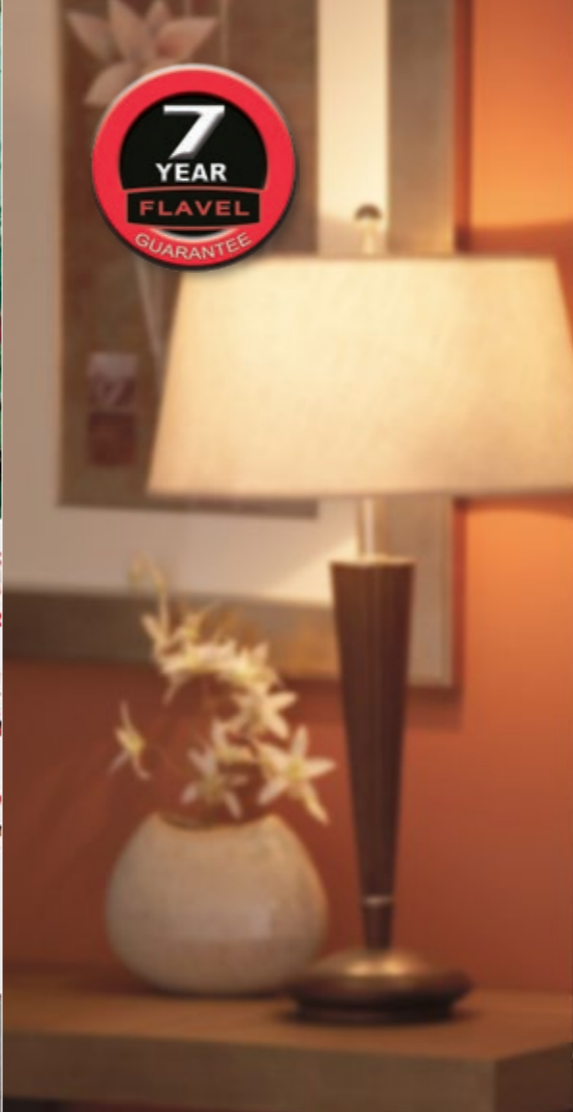

Orchestra BF in brass



Finesse with coal effect



Finesse with pebble effect

high efficiency Balanced Flue – Hearth Inset – Glass Fronted



Orchestra BF

If you want the warmth and mood created by a living flame fire yet don't have a chimney or flue, then the Orchestra is the perfect solution. This neat, glass fronted inset fire with an energy efficiency of 80% is framed by a chamfered trim and sleek fret.

Specifications

Description: Slimline inset gas fire **Type of Heat:** Radiant & Convected

Useful energy efficiency	80%
Energy efficiency class	E
Fuel type	Natural gas
Direct heat output	2.7kW

Control type	Colour	Model Number
Manual	Satin Silver	FBFN98G
	Brass	FBFN76G

Safety: Flame Supervision Device
Air vent required: Not normally

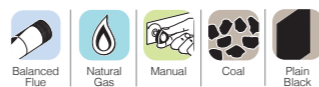

Dimensions

- A 620mm
- B 470mm
- C 580mm
- D 125mm
- E 95mm
- F 435mm
- G 675mm max - 130mm min*
- H 400mm
- I 145mm

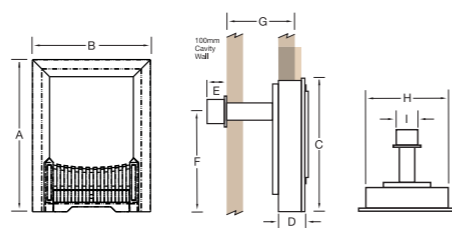

standard fires Conventional Flue – Wall Inset – Open Fronted

Finesse

The most versatile hole-in-the-wall gas fire from Flavel. The Finesse will fit virtually any flue and is available in three different variations – a brass trim option with coal fuel effect to suit a classical setting and a chrome trim option with a choice of coal or pebble fuel effect.

Specifications

Description: Slimline inset gas fire **Type of Heat:** Radiant

Fuel type	Natural gas
Direct heat output	2.7kW

Fuel effect	Control type	Colour	Model Number
Coal	Manual	Chrome	FSRCYYMN
Pebble		Chrome	FSRPYYMN

Safety: Flame Supervision Device & Airwatch System
Air vent required: Not normally
This product is not suitable for primary heating purposes.



Dimensions

- A 690mm
- B 558mm
- C 550mm
- D 120mm
- E 329mm
- F 50mm

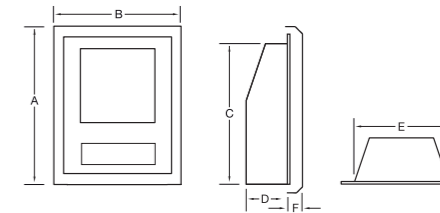



Windsor Contemporary with pebble fuel effect



standardfires Conventional Flue – Wall Inset – Open Fronted

Windsor Contemporary

The Windsor Wall inset open fronted gas fire is available in a choice of coal or pebble fuel bed and features a large viewing window. This extremely versatile fire will fit into almost any chimney or flue and comes in a chrome finish.

Specifications

Description: Slimline inset gas fire Type of Heat: Radiant

Fuel type	Natural gas
Direct heat output	2.7kW

Fuel effect	Control type	Colour	Model Number
Coal	Manual	Chrome	FSRCHWMN
Pebble			FSRPHWMN

Safety: Flame Supervision Device & Airwatch System
 Air vent required: Not normally
 This product is not suitable for primary heating purposes.



Dimensions

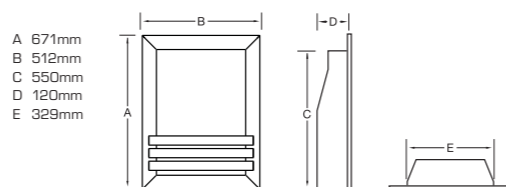

Windsor Contemporary with coal fuel effect

standardfires Conventional – Hearth Inset – Open Fronted

Waverley

The Waverley, with its beautiful decorative flame effect, is a perfect replacement for a solid fuel grate. The 16" tapered inset tray is designed to fit a standard 16" fire back, providing a realistic coal effect for almost any style of fireplace.

Specifications

Description: Full depth inset tray Type of Heat: Radiant

Fuel type	Natural gas
Direct heat output	2.7kW

Control type	Model Number
Manual	FITCOOMN

Safety: Flame Supervision Device & Airwatch System
 Air vent required: Not normally
 This product is not suitable for primary heating purposes



Dimensions

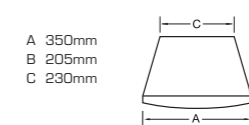



Linear with pebble fuel effect



Caress Slimline manual control in brass

standardfires Conventional – Hearth Inset – Open Fronted

Linear

The Linear is a stunning modern design with the combination of black ribbed back panels and chrome fascia. This mid depth gas fire delivers a wonderful flickering glow and can be installed into almost any chimney or flue including a pre-cast flue with a 3" rebated surround.

Specifications

Description: Mid depth inset gas fire Type of Heat: Radiant

Fuel type	Natural gas
Direct heat output	2.7kW

Fuel Effect	Control type	Colour	Model Number
Coal	Manual	Chrome	FRDCUOMN
Pebble			FRDPUOMN

Safety: Flame Supervision Device & Airwatch System
Air vent required: Not normally

This product is not suitable for primary heating purposes.



Dimensions

- A 595mm
- B 483mm
- C 550mm
- D 170mm
- E 365mm

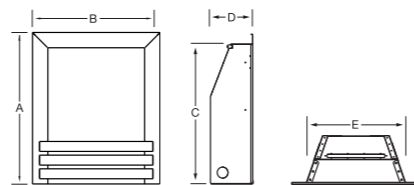

Linear with coal fuel effect

standardfires Conventional Flue – Hearth Inset – Open Fronted



Caress Slimline

The Caress Slimline gas fire features a fabulous, top quality cast trim and Blenheim fret in a choice of solid cast brass or chrome cast iron. Coal effect and flame picture differs on slide control models.

Specifications

Description: Slimline inset gas fire Type of Heat: Radiant

Manual Control

Fuel type	Natural gas
Direct heat output	2.7kW

Control type	Colour	Model Number
Manual	Brass	FSRCBCMN
	Chrome	FSRCCCMN

This product is not suitable for primary heating purposes

Slide Control

Useful energy efficiency	53.1%
Energy efficiency class	F
Fuel type	Natural gas
Direct heat output	3.1kW

Control type	Colour	Model Number
Slide	Brass	FNVCBCSN
	Chrome	FNVCCSN

Safety: Flame Supervision Device & Airwatch System
Air vent required: Not normally



Dimensions

- | | |
|--------------------------------|-------------------------------|
| Caress Slimline Manual Control | Caress Slimline Slide Control |
| A 615mm | A 615mm |
| B 510mm | B 510mm |
| C 550mm | C 550mm |
| D 120mm | D 105mm |
| E 329mm | E 325mm |

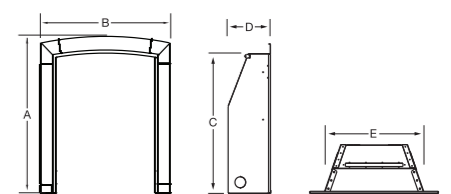

*Caress Slimline Slide Control in chrome cast iron

Windsor Contemporary, Classic & Traditional

The versatile styling of the Windsor gas fires ensures that there is a style to suit any room. This slimline gas fire will fit almost any chimney or flue, including pre-cast (BS EN 1858).



Windsor Contemporary with satin silver fascia and pebble fuel effect

Windsor Contemporary with chrome fascia and driftwood fuel effect

Windsor Classic with chrome trim and fret and coal fuel effect

Windsor Traditional with chrome trim and fret and coal fuel effect

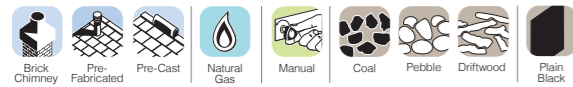

Specifications

Description: Slimline inset gas fire Type of Heat: Radiant

Fuel Type	Natural gas
Direct heat output	2.7kW

Windsor Contemporary

Fuel effect	Control type	Colour	Model Number
Coal	Manual	Chrome	FSRCUOMN
		Satin Silver	FSRCBOMN
		Brass	FSRCU1MN
Pebble	Manual	Chrome	FSRPUOMN
		Satin Silver	FSRPBOMN
Driftwood	Manual	Chrome	FSRDUOMN

Windsor Classic

Fuel effect	Control type	Colour	Model Number
Coal	Manual	Brass	FSRC1SMN
		Chrome	FSRC3WMN

Windsor Traditional

Fuel effect	Control type	Colour	Model Number
Coal	Manual	Brass	FSRC1PMN
		Chrome	FSRC3JMN

Safety: Flame Supervision Device & Airwatch System

Air vent required: Not normally

This product is not suitable for primary heating purposes

Dimensions

Windsor Contemporary	Windsor Traditional & Classic
A 592mm	A 592mm
B 475mm	B 475mm
C 550mm	C 550mm
D 120mm	D 120mm
E 329mm	E 329mm



Windsor Traditional in brass with coal fuel effect



Melody in chrome



Regent LFE in black

standardfires Conventional Flue – Hearth Inset – Open Fronted



Melody

The Melody is an elegant slimline fire enabling installation in almost any flue including pre-cast. The discreet slide control ensures convenient operation with a heat output of 3.1kW.

Specifications

Description: Slimline inset gas fire **Type of Heat:** Radiant

Useful energy efficiency	53.1%
Energy efficiency class	F
Fuel type	Natural gas
Direct heat output	3.1kW

Control type	Colour	Model Number
Slide	Chrome	FDRN68G
	Brass	FDRN45G
	Antique Brass	FDRN46G
	Black	FDRN57G

Safety: Flame Supervision Device & Airwatch System
Air vent required: Not normally



Dimensions

- A 605mm
- B 491mm
- C 550mm
- D 105mm
- E 325mm

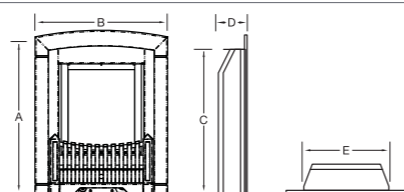

Melody in antique brass

Melody in black

Melody in brass

standardfires Conventional – Hearth Outset – Open Fronted



Regent LFE

One of the most popular radiant fires in the UK, The Regent LFE is slim for a neat fit into an existing fireplace and is highly efficient. It provides radiant and convected heat and is an elegant interpretation of the Regency period.

Specifications

Description: Full depth outset gas fire **Type of Heat:** Radiant

Useful energy efficiency	59.3%
Energy efficiency class	F
Fuel type	Natural gas
Direct heat output	3.3kW

Control type	Colour	Model Number
Electronic Side	Black	FRLCNOEN
	Bronze	FRLCPOEN
Remote	Black	FRLCNORN2
	Bronze	FRLCPORN2

Safety: Flame Supervision Device & Airwatch System
Air vent required: Not normally



Dimensions

- A 680mm
- B 710mm
- C 255mm

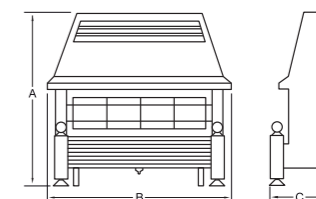

Regent LFE in bronze

Calculating your Flavel gas fires running costs



Windsor Traditional HE brass Page 23

Despite rising fuel prices, natural gas remains the most common and one of the cheapest ways to heat your home.

Since the cost of gas can differ depending on service provider, location and tariff we do not include estimated running costs for our products. However, you can estimate your own running costs easily using the following calculation:-

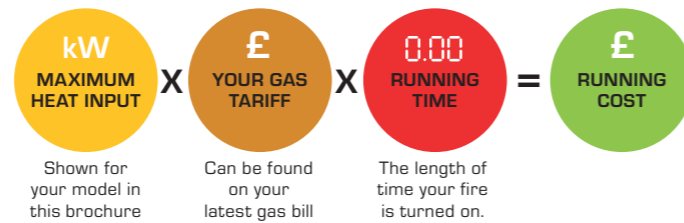

Example

What is the running cost of the Windsor Traditional HE when used for 3 hours at a cost of 4.2p per kilowatt hour?



Online inspiration & information

Tap into a wealth of knowledge and discover everything you need to know about purchasing, fitting and servicing your Flavel fire.

- Use our intelligent search tools to find your perfect gas fire
- Watch videos of our stunning fires
- Download Installation and User manuals
- Find your nearest Flavel Approved Stockist
- Register your guarantee



www.flavelfires.co.uk

Builders' Opening sizes

Product	Minimum Opening Width	Maximum Opening Width	Minimum Opening Height	Maximum Opening Height
Calibre BF	415mm	420mm	563mm	570mm
Calypso	400mm	450mm	550mm	570mm
Calypso Plus	370mm	440mm	550mm	570mm
Caress	400mm	450mm	550mm	570mm
Caress HE	400mm	450mm	550mm	570mm
Caress Plus	370mm	440mm	550mm	570mm
Caress Slimline SC	330mm	430mm	550mm	565mm
Caress Slimline MC	330mm	440mm	550mm	575mm
Curve	300mm	440mm	300mm	440mm
Decadence HE	370mm	450mm	550mm	570mm
Decadence Plus	370mm	440mm	550mm	570mm
Decadence Slimline	330mm	440mm	550mm	575mm
Diamond HE	370mm	450mm	550mm	570mm
Emberglow	305mm	440mm	500mm	650mm
Expression HE	370mm	450mm	550mm	570mm
Expression Plus	370mm	440mm	550mm	570mm
Finesse	330mm	430mm	550mm	575mm
Firenza	305mm	440mm	510mm	650mm
Jazz HE	650mm	660mm	460mm	470mm
Jazz BF	635mm	645mm	465mm	475mm
Kenilworth HE	370mm	450mm	550mm	570mm
Kenilworth Plus	370mm	440mm	550mm	570mm
Linear HE	370mm	450mm	550mm	570mm
Linear	375mm	440mm	550mm	570mm
Linear Plus	370mm	440mm	550mm	570mm
Melody	330mm	430mm	550mm	565mm
Misermatic	305mm	440mm	580mm	650mm
Orchestra BF	410mm	420mm	555mm	565mm
Raglan BF	410mm	420mm	555mm	565mm
Regent	305mm	440mm	470mm	650mm
Regent LFE	305mm	440mm	525mm	650mm
Renaissance	305mm	440mm	580mm	650mm
Renoir	305mm	440mm	500mm	650mm
Rhapsody	400mm	450mm	550mm	570mm
Richmond	400mm	450mm	550mm	570mm
Richmond Plus	400mm	450mm	550mm	570mm
Rocco HE	750mm	760mm	520mm	530mm
Rocco BF	730mm	780mm	540mm	550mm
Romance	400mm	450mm	550mm	570mm
Sophia	760mm	790mm	870mm	880mm
Sophia Slimline BF	750mm	840mm	1025mm	1050mm
Stirling Plus	330mm	440mm	550mm	575mm
Strata	305mm	440mm	580mm	650mm
Waverley*	400mm	440mm	550mm	575mm
Waverley**	560mm	600mm	690mm	720mm
Welcome	305mm	440mm	470mm	650mm
Windsor	330mm	440mm	550mm	575mm
Windsor HE	330mm	440mm	550mm	575mm
Windsor Plus	330mm	440mm	550mm	575mm

*when fitted into standard builders opening with existing chair-brick

**when fitted with "Victorian" style casting

WARNING BFM Europe Limited is a Gas Safe Registered company. We recommend that all of our fires are installed by Gas Safe Register engineers in accordance with our instructions.

DISCLAIMER Our policy is one of constant development and improvement. We therefore reserve the right to revise designs and specifications of our products without formal notice, patents pending. We always recommend our products be viewed in an approved showroom before purchase.

Whilst we have taken every care in the preparation of this brochure it is not intended to replace the installation manual which provides more detailed information. Photography is for illustration purposes only and although every effort has been made to ensure accurate reproduction of typical installations and flame pictures they may vary according to fire model and flue types.

We accept no liability for any loss or damage arising directly or indirectly from the use of this brochure.

We recommend that all our fires are used in conjunction with central heating and not as a primary source of heat. In the interests of personal safety a suitable fireguard is recommended when children, the elderly and the infirm are present. (This brochure is copyright and must not be reproduced in whole or in any part without prior written permission).



www.flavelfires.co.uk

Visit our Flavel website on your smart phone or tablet device, just scan in this QR code.

We would like to thank Kedleston Heating (01332 200303), Olde England Reproductions (01782 319350), Stanningley Firesides (0113 257 1512) and GB Mantles (01924 473243) for contributing fire surrounds to this brochure.



Find us on Facebook, Twitter, Pinterest & YouTube



At the heart of your home

BFM Europe Limited, Trentham Lakes, Stoke-on-Trent, Staffordshire ST4 4TJ.
Tel: 01782 339000. www.flavelfires.co.uk e-mail: info@bfm-europe.com

Issue No. 41a