



**CELSI**   
*...the future of fire*



PREMIUM ELECTRIC FIRES COLLECTION 2021





## WELCOME TO CELSI

At Celsi we know how important it is to create a stylish and relaxing living environment. That's why we've developed this collection of premium electric fires.

I believe our success stems from a combination of innovative design, investment in technology and the highest quality manufacturing standards. As a result all Celsi fires carry a 2 or 5 year guarantee\* to reflect my belief in their quality and durability.

This brochure has been designed to make the purchase of your new Celsi heater as simple as possible. I hope you find it both informative and inspiring.



## ADVANCED FEATURES



### THERMOSTATIC HEATING

Pre-set your heat comfort level for automatic temperature control via the handset.



### TIMER FUNCTION

Programmable 7-day heating timer function with hourly on/off control. Up to 8 hrs sleep timer facility available on some models.



### LED EFFICIENCY

From controllable flame picture and fuel bed brightness, to colour changing mood lighting, our onboard LED's ensure effective energy saving low power consumption.



### ISOFLAME

Independent flame effect capable of displaying in isolation when no heat is required from the appliance.



### FLAME FUSION

Captivating Indigo blue flame feature creates a colourful impression by fusing soft and natural yellow flames with an attractive flare of blue flame intensity.



### COLOUR CYCLE

Fix your favourite or go dynamic as you cycle through an array of impressive colour changing fuel bed options.



### MOOD LIGHTS

Designed to enhance your experience with an ambient stream of colour rich soft LED lighting. Select from a choice of colours to compliment both warm and cool home interiors, or simply to suit your mood.



### ECODESIGN COMPLIANT

Integrated design features for optimal energy saving performance and assurance.



We are confident you are getting a product that is built to last. That's why we offer a 2 Year Guarantee across our electric fires range, with an extended guarantee to 5\* years on selected Celsi models.

## There is no more versatile fuel for home heating than electricity

With a range that includes beautifully crafted electric suites, feature fireplace wall models, classically styled hearth inset fires, and contemporary stove designs, there is a Celsi fire to suit any home.

Best of all you are free to enjoy any of these fantastic heating appliances in any room in your home simply by plugging into the nearest mains socket.

To learn more about the features and benefits of owning a Celsi electric fire please sit back and take a few moments to look through our Advanced Features section, along with our technology introduction to assist you in choosing your perfect Celsi fire experience.



SUITES - E-VR Volare 1100 - Pages 6 - 7



STOVES - E-VR Rochester - Pages 30 - 31



WALL FIRES - U-VR Vichy Satin Champagne - Page 54



HEARTH FIRES - U-VR Camber Satin Silver - Page 64

## ELECTRIFLAME®VR & ELECTRISTOVE®VR

Virtual Reality – Advanced Flame Projection



View our latest range of Electriflame VR '3-Sided Glass Fires and Suites' for superior flame aesthetics. This latest patented design raises the appearance and functionality of electric fires to a new level.

Conventional electric fires feature flames on a flat screen at the rear of the product, with E-VR Flame Projection Technology we create the flame illusion to the front, the centre, and the rear of the fuel bed. This creates a totally natural log fire effect, within a range of free-standing Suites, wall mounted fires, hearth inset fires, and outset Stoves.

### Outset Suites

E-VR Volare 1100 Illumia	6-7
E-VR Media 1100 Illumia	8
E-VR Carino 1100 Illumia	9
E-VR Volare 750 Illumia	10-11
E-VR Media 750 Illumia	12
E-VR Carino 750 Illumia	13
E-VR Orbital 1000 Illumia	14-15

### Wall Outset

E-VR 1400	16-17
E-VR 1100	18-19
E-VR 750	20
E-VR Louvre	21
E-VR Basilica	22

### Wall Inset

E-VR Commodus	23
E-VR Metz	24
E-VR Vichy	25

### Hearth Inset

E-VR Acero	26-27
E-VR Parrilla	28
E-VR Contemporary	29

### Outset Stoves

E-VR Rochester	30-31
E-VR Arundel	32
E-VR Luxima	33

## ULTIFLAME® VR

Virtual Reality – True Flame Experience



An exceptional range of fires and suites using 'Open' or 'Glass Fronted' Ultriflame VR technology. At the touch of a button these natural log effect fires display an illusion of hot crystal embers and intense flame captivation.

Discover our classic and contemporary styles including luxury Limestone Suites with integrated feature lighting, beautiful wall and hearth inset models, all designed to look sensational and create comfortable controllable warmth.

### Outset Suites

U-VR Adour Elite Illumia	34-35
U-VR Orbital 800 Illumia	36
U-VR Vega	37
U-VR Gemma 800 Illumia	38-39
U-VR Adour Aleesia Illumia	40
U-VR Adour Asencio Illumia	41
U-VR Gemma 600 Illumia	42
U-VR Adour Illumia	43
U-VR Canelo Illumia	44
U-VR Elara	45

### Inset Limestone Suites

U-VR Parada Elite Illumia	46
U-VR Avignon Elite	47
U-VR Aleesia Illumia	48
U-VR Asencio	49
U-VR Angelo	50
U-VR Boticelli	51
U-VR Pablo	52

### Wall Inset

U-VR Elite	53
U-VR Vichy	54
U-VR Metz	55
U-VR Instinct	56
U-VR Evora Asencio & Asencio	57
U-VR Vader Aleesia & Aleesia	58-59
U-VR Celena	60
U-VR Impulse	61

### Hearth Inset

U-VR Arcadia	62
U-VR Decadence	63
U-VR Camber	64
U-VR Frontier	65
U-VR Essence	66
U-VR Designer	67
U-VR Endura	68
U-VR Contemporary	69

## PURAFLAME®

Ultra High Technology Experience



Combining style with innovation, Puraflame technology provides a simple to use convincing fire experience, with exceptional feature rich functionality.

Using LCD technology Puraflame is the only electric fire to give you a choice of three flame pictures plus the astonishing look and sound of a real fire.

### Wall Outset

Puraflame Panoramic	70-71
---------------------	-------

## FLAMONIK & ACCENT

Inspired Flame Effect Technologies



Through illusion and LED light technology beautiful flames emerge to provide a range of distinctive electric fire effects that will bewilder and excite.

### Wall Outset

Flamonik Rapture	72
Flamonik Enchant	73

### Hearth Inset

Accent Traditional	74
Accent Infusion	75

## ELECTRIFLAME®XD & ELECTRISTOVE®XD

Xtra Dimensional – High Definition Fire



Electriflame XD is a 'Glass Fronted' extra deep fuel effect with high definition 3D flames. The E-XD range features impressive landscape 'hang-on-the-wall' fires framed with natural stone, premier board, and full glass fascia's.

Our hearth inset fires and stoves provide a wide selection of designs that complement both modern and traditional home interiors.

### Wall Outset

E-XD Prestige	76-77
E-XD Black Glass	78
E-XD Royal Botticino	79
E-XD Travertine	80
E-XD Piano Black	81

### Hearth Inset

E-XD Camber	82
E-XD Decadence	83
E-XD Essence	84
E-XD Arcadia	85
E-XD Signature	86-87
E-XD Daisy	88
E-XD Caress	89
E-XD Bauhaus	90-91

### Outset Stoves

Electristove XD Metal 1 & 2	92-93
Electristove XD Glass 1 & 2	94-95

## DIMENSIONS

96-103

# ELECTRIFLAME VOLARE 1100

E-VR Outset Illumia Suite

## Features

- Flame Projection Technology
- 3 sided glass fire
- LED surround lighting
- Customisable fuel effect
- Silver birch logs
- Crystal ash embers
- Single or dual colour flame
- LED brightness control
- Thermostatic remote & manual control operation
- Includes wall fixing bracket



Flame Projection Technology



## Specification

Suite Dimensions: mm	H-721 x W-1595 x D-406
Heat Output	1.0kW – 2.0kW
Suite Finish Painted	<input type="checkbox"/> Smooth White



Video

# ELECTRIFLAME MEDIA 1100

E-VR Outset Illumia Suite



Video



## Features

- Flame Projection Technology
- 3 sided glass fire
- LED surround lighting
- Media storage
- Customisable fuel effect
- Silver birch logs
- Crystal ash embers
- Single or dual colour flame
- LED brightness control
- Thermostatic remote & manual control operation

Flame Projection Technology



## Specification

Suite Dimensions: mm	H-1126 x W-1595 x D-408
Heat Output	1.0kW - 2.0kW
Suite Finish	<input type="checkbox"/> Smooth White
Painted	

# ELECTRIFLAME CARINO 1100

E-VR Outset Illumia Suite



Video



## Features

- Flame Projection Technology
- 3 sided glass fire
- LED surround lighting
- Customisable fuel effect
- Silver birch logs
- Crystal ash embers
- Single or dual colour flame
- LED brightness control
- Thermostatic remote & manual control operation

Flame Projection Technology



## Specification

Suite Dimensions: mm	H-840 x W-1467 x D-370
Heat Output	1.0kW - 2.0kW
Suite Finish	<input type="checkbox"/> Smooth White
Painted	



## ELECTRIFLAME VOLARE 750

E-VR Outset Illumia Suite

### Features

- Flame Projection Technology
- 3 sided glass fire
- LED surround lighting
- Customisable fuel effect
- Silver birch logs
- Crystal ash embers
- Single or dual colour flame
- LED brightness control
- Thermostatic remote & manual control operation



THERMO-  
STATIC



7 DAY  
TIMER



ENERGY  
SAVING



ISO  
FLAME



FLAME  
FUSION

### Optional Extras

Woodland logs fuel effect



Video

### Specification

Suite Dimensions: mm	H-721 x W-1400 x D-406
Heat Output	1.0kW – 2.0kW
Suite Finish Painted	<input type="checkbox"/> Smooth White

# ELECTRIFLAME MEDIA 750

E-VR Outset Illumia Suite



Video



## Features

- Flame Projection Technology
- 3 sided glass fire
- LED surround lighting
- Media storage
- Customisable fuel effect
- Silver birch logs
- Crystal ash embers
- Single or dual colour flame
- LED brightness control
- Thermostatic remote & manual control operation

## Optional Extras

Woodland logs fuel effect



## Specification

Suite Dimensions: mm	H-1126 x W-1400 x D-408
Heat Output	1.0kW - 2.0kW
Suite Finish Painted	<input type="checkbox"/> Smooth White

# ELECTRIFLAME CARINO 750

E-VR Outset Illumia Suite



Video



## Features

- Flame Projection Technology
- 3 sided glass fire
- LED surround lighting
- Customisable fuel effect
- Silver birch logs
- Crystal ash embers
- Single or dual colour flame
- LED brightness control
- Thermostatic remote & manual control operation

## Optional Extras

Woodland logs fuel effect



## Specification

Suite Dimensions: mm	H-840 x W-1118 x D-370
Heat Output	1.0kW - 2.0kW
Suite Finish Painted	<input type="checkbox"/> Smooth White

# ELECTRIFLAME ORBITAL 1000

E-VR Outset Illumia Suite

## Features

- Flame Projection Technology
- Glass fronted fire
- LED surround lighting
- Customisable fuel effect
- Silver birch logs
- Crystal ash embers
- Single or dual colour flame
- LED brightness control
- Thermostatic remote & manual control operation



Smooth Mist



Smooth Cream



Smooth White

## Specification

Suite Dimensions: mm	H-855 x W-1600 x D-360
Heat Output	0.8kW – 1.6kW
Suite Finishes Painted	<input type="checkbox"/> Smooth White <input type="checkbox"/> Smooth Mist <input type="checkbox"/> Smooth Cream



Video





## ELECTRIFLAME 1400

E-VR Wall Outset

### Features

- Flame Projection Technology
- 3 sided glass fire
- Customisable fuel effect
- Silver birch logs
- Crystal ash embers
- Single or dual colour flame
- LED brightness control
- Thermostatic remote & manual control operation
- Side blanking installation options



THERMO-  
STATIC



7 DAY  
TIMER



ENERGY  
SAVING



ISO  
FLAME



FLAME  
FUSION

Flame Projection Technology



Video

### Specification

Fire Dimensions: mm	H-375 x W-1430 x D-275
Heat Output	1.0kW - 2.0kW

# ELECTRIFLAME 1100

E-VR Wall Outset

## Features

- Flame Projection Technology
- 3 sided glass fire
- Customisable fuel effect
- Silver birch logs
- Crystal ash embers
- Single or dual colour flame
- LED brightness control
- Thermostatic remote & manual control operation
- Side blanking installation options



Flame Projection Technology



## Specification

Fire Dimensions: mm	H-374 x W-1430 x D-275
Heat Output	1.0kW – 2.0kW



Video

# ELECTRIFLAME 750

E-VR Wall Outset



Video



## Features

- Flame Projection Technology
- 3 sided glass fire
- Customisable fuel effect
- Silver birch logs
- Crystal ash embers
- Single or dual colour flame
- LED brightness control
- Thermostatic remote & manual control operation
- Side blanking installation options

## Optional Extras

Woodland logs fuel effect



## Specification

Fire Dimensions: mm	H-374 x W-780 x D-275
Heat Output	0.8kW - 1.6kW

# ELECTRIFLAME LOUVRE

E-VR Wall Outset



Video



## Features

- Flame Projection Technology
- Glass fronted fire
- Customisable fuel effect
- Woodland logs
- Crystal ash embers
- Single or dual colour flame
- LED brightness control
- Thermostatic remote & manual control operation
- Includes wall fixing bracket



## Specification

Dimensions: mm	H-519 x W-1102 x D-201
Heat Output	0.8kW - 1.6kW

## Finish

Steel Fabricated & Glass Fascia  
Dual Finish  
Brushed Metallic

Satin Silver & Black Glass

# ELECTRIFLAME BASILICA

E-VR Wall Outset



Video



Satin Champagne & Black

## Features

- Flame Projection Technology
- Glass fronted fire
- Customisable fuel effect
- Silver birch logs
- Crystal ash embers
- Single or dual colour flame
- LED brightness control
- Thermostatic remote & manual control operation
- Includes wall fixing bracket
- Wall inset option



Satin Silver & Black



## Specification

Dimensions: mm	H-570 x W-1400 x D-90
Heat Output	0.8kW - 1.6kW

## Finishes

Steel Fabricated Fascia  
Dual Finished  
Brushed Metallic  
Black Painted



# ELECTRIFLAME COMMODUS

E-VR Wall Inset



Video



## Features

- Flame Projection Technology
- Glass fronted fire
- Customisable fuel effect
- Silver birch logs
- Crystal ash embers
- Single or dual colour flame
- LED brightness control
- Thermostatic remote & manual control operation

## Flame Projection Technology



## Specification

Fire Dimensions: mm	H-330 x W-981 x D-169
Heat Output	0.8kW - 1.6kW

# ELECTRIFLAME METZ

E-VR Wall Inset



Video



## Features

- Flame Projection Technology
- Glass fronted fire
- Customisable fuel effect
- Silver birch logs
- Crystal ash embers
- Single or dual colour flame
- LED brightness control
- Thermostatic remote & manual control operation



## Specification

Dimensions: mm	H-570 x W-1400 x D-24
Heat Output	0.8kW - 1.6kW

## Finishes

Steel Fabricated Fascia Brushed Metallic	Satin Champagne
---	-----------------

# ELECTRIFLAME VICHY

E-VR Wall Inset



Video



Satin Champagne

## Features

- Flame Projection Technology
- Glass fronted fire
- Customisable fuel effect
- Silver birch logs
- Crystal ash embers
- Single or dual colour flame
- LED brightness control
- Thermostatic remote & manual control operation



## Specification

Dimensions: mm	H-523 x W-1653 x D-87
Heat Output	0.8kW - 1.6kW



Satin Silver

## Finishes

Steel Fabricated Fascia Brushed Metallic	Satin Silver
	Satin Champagne



Chrome & Black Nickel

## ELECTRIFLAME ACERO

E-VR Hearth Inset

### Features

- Aspirational 26 inch fascia
- Flame Projection Technology
- Extra wide glass fronted fire
- Customisable fuel effect
- Silver birch logs
- Crystal ash embers
- Single or dual colour flame
- LED brightness control
- Thermostatic remote & manual control operation



Chrome & Satin Silver

Flame Projection Technology



Video

### Specification

Dimensions: mm	H-655 x W-657 x D-67
Heat Output	0.8kW – 1.6kW
Finishes	<input type="checkbox"/> Chrome & Satin Silver <input type="checkbox"/> Chrome & Black Nickel
Steel Fabricated Fascia	
Dual Finished	
Twin Metallic	

# ELECTRIFLAME PARRILLA

E-VR Hearth Inset



Video



Satin Champagne

## Features

- Flame Projection Technology
- Extra wide glass fronted fire
- Customisable fuel effect
- Silver birch logs
- Crystal ash embers
- Single or dual colour flame
- LED brightness control
- Thermostatic remote & manual control operation



Satin Silver

## Specification

Dimensions: mm	H-602 x W-544 x D-90
Heat Output	0.75kW - 1.5kW

## Finishes

Steel Fabricated Fascia	Satin Silver
Brushed Metallic	Satin Champagne

# ELECTRIFLAME CONTEMPORARY

E-VR Hearth Inset



Video



Satin Silver

## Features

- Flame Projection Technology
- Extra wide glass fronted fire
- Customisable fuel effect
- Silver birch logs
- Crystal ash embers
- Single or dual colour flame
- LED brightness control
- Thermostatic remote & manual control operation



Satin Champagne

## Finishes

Steel Fabricated Fascia	Satin Silver
Brushed Metallic	Satin Champagne

## Specification

Dimensions: mm	H-602 x W-544 x D-90
Heat Output	0.75kW - 1.5kW

# ELECTRISTOVE ROCHESTER

E-VR Outset Stove

## Features

- Flame Projection Technology
- Tough steel body
- Curved door design
- Customisable fuel effect
- Silver birch logs
- Crystal ash embers
- Single or dual colour flame
- LED brightness control
- Thermostatic remote & manual control operation



## Optional Extras

Woodland logs fuel effect



## Specification

Dimensions: mm	H-606 x W-532 x D-372
Heat Output	1.0kW – 2.0kW
Finish	Black
Steel Fabricated Painted	



Video



# ELECTRISTOVE ARUNDEL

E-VR Outset Stove



Video



## Features

- Flame Projection Technology
- Tough steel body
- Customisable fuel effect
- Silver birch logs
- Crystal ash embers
- Single or dual colour flame
- LED brightness control
- Thermostatic remote & manual control operation



## Optional Extras

Woodland logs fuel effect



## Specification

Dimensions: mm	H-582 x W-430 x D-389
Heat Output	0.75kW - 1.5kW

## Finish

Steel Fabricated  
Painted



Black

# ELECTRISTOVE LUXIMA

E-VR Outset Stove



Video



## Features

- Flame Projection Technology
- Tough steel body
- Customisable fuel effect
- Silver birch logs
- Crystal ash embers
- Single or dual colour flame
- LED brightness control
- Thermostatic remote & manual control operation



## Optional Extras

Woodland logs fuel effect



## Finish

Steel Fabricated  
Painted



Black

## Specification

Dimensions: mm	H-595 x W-471 x D-359
Heat Output	0.75kW - 1.5kW

Smooth White



## ULTIFLAME ADOUR ELITE

U-VR Outset Illumia Suite

### Features

- Open fire experience
- LED surround lighting
- Customisable fuel effect
- Silver birch logs
- Crystal ash embers
- Single or dual colour flame
- LED brightness control
- Thermostatic remote & manual control operation



Smooth Mist



Smooth Cream



Video

### Specification

Suite Dimensions: mm	H-990 x W-1465 x D-380
Heat Output	0.8kW - 1.6kW
Suite Finishes Painted	<input type="checkbox"/> Smooth White <input type="checkbox"/> Smooth Mist <input type="checkbox"/> Smooth Cream

# ULTIFLAME ORBITAL 800

U-VR Outset Illumia Suite



Video



Smooth Mist

## Features

- Open fire experience
- LED surround lighting
- Customisable fuel effect
- Silver birch logs
- Crystal ash embers
- Single or dual colour flame
- LED brightness control
- Thermostatic remote & manual control operation



Smooth Cream



Smooth White



## Specification

Suite Dimensions: mm	H-850 x W-1466 x D-360
Heat Output	0.8kW - 1.6kW

## Suite Finishes

- Painted
- Smooth White
  - Smooth Mist
  - Smooth Cream

# ULTIFLAME VEGA

U-VR Outset Suite



Video



Smooth White

## Features

- Open fire experience
- Customisable fuel effect
- Silver birch logs
- Crystal ash embers
- Single or dual colour flame
- LED brightness control
- Thermostatic remote & manual control operation



Smooth Mist



Smooth Cream



## Specification

Suite Dimensions: mm	H-892 x W-1430 x D-330
Heat Output	0.8kW - 1.6kW

## Suite Finishes

- Painted Surround  
Black interior
- Smooth White
  - Smooth Mist
  - Smooth Cream

# ULTIFLAME GEMMA 800

U-VR Outset Illumia Suite

## Features

- Open fire experience
- Dimmable LED surround lighting
- Customisable fuel effect
- Silver birch logs
- Crystal ash embers
- Single or dual colour flame
- LED brightness control
- Thermostatic remote & manual control operation



Smooth White



Textured Black & White



Textured White

## Specification

Suite Dimensions: mm	H-740 x W-1465 x D-360
Heat Output	0.8kW - 1.6kW
Suite Finish Painted	<input type="checkbox"/> Smooth White <input checked="" type="checkbox"/> Textured White <input type="checkbox"/> Textured Black



Video

# ULTIFLAME ADOUR ALESSIA

U-VR Outset Illumia Suite



Video



## Features

- Glass Fronted Fire
- LED surround lighting
- Customisable fuel effect
- Silver birch logs
- Crystal ash embers
- Single or dual colour flame
- LED brightness control
- Thermostatic remote & manual control operation



Smooth White with Black interior and hearth



## Specification

Suite Dimensions: mm	H-990 x W-1465 x D-380
Heat Output	0.8kW – 1.6kW

## Suite Finishes

Painted surround  
Black interior and  
hearth option

Smooth White

# ULTIFLAME ADOUR ASENCIO

U-VR Outset Illumia Suite



Video



## Features

- Glass Fronted Fire
- LED surround lighting
- Customisable fuel effect
- Silver birch logs
- Crystal ash embers
- Single or dual colour flame
- LED brightness control
- Thermostatic remote & manual control operation

Flame Fusion – dual colour



## Specification

Suite Dimensions: mm	H-1090 x W-1340 x D-380
Heat Output	0.8kW – 1.6kW

## Suite Finishes

Painted surround  
Black interior and hearth

Smooth White

# ULTIFLAME GEMMA 600

U-VR Outset Illumia Suite



Video



## Features

- Open Fronted Fire
- Dimmable LED surround lighting
- Customisable fuel effect
- Silver birch logs
- Crystal ash embers
- Single or dual colour flame
- LED brightness control
- Thermostatic remote & manual control operation



## Specification

Suite Dimensions: mm	H-835 W-1185 D-360
Heat Output	0.8kW - 1.6kW



Smooth White



Textured Black & White

## Suite Finishes

- Painted
- Smooth White
  - Textured White
  - Textured Black

# ULTIFLAME ADOUR

U-VR Outset Illumia Suite



Video



## Features

- Open fire experience
- LED surround lighting
- Customisable fuel effect
- Silver birch logs
- Crystal ash embers
- Single or dual colour flame
- LED brightness control
- Thermostatic remote & manual control operation



## Specification

Suite Dimensions: mm	H-1090 x W-1340 x D-380
Heat Output	0.8kW - 1.6kW



Smooth Cream



Smooth Mist

## Suite Finishes

- Painted surround  
Black interior and hearth
- Smooth White
  - Smooth Mist
  - Smooth Cream

# ULTIFLAME CANELO

U-VR Outset Illumia Suite



Video



## Features

- Open fire experience
- Dimmable LED surround lighting
- Customisable fuel effect
- Silver birch logs
- Crystal ash embers
- Single or dual colour flame
- LED brightness control
- Thermostatic remote & manual control operation



## Specification

Suite Dimensions: mm	H-1090 W-1340 D-340
Heat Output	0.8kW - 1.6kW

## Suite Finishes

Painted Surround  
Black interior



# ULTIFLAME ELARA

U-VR Outset Suite



Video



Smooth Mist

## Features

- Open fire experience
- Customisable fuel effect
- Silver birch logs
- Crystal ash embers
- Single or dual colour flame
- LED brightness control
- Thermostatic remote & manual control operation



## Specification

Suite Dimensions: mm	H-892 x W-1228 x D-330
Heat Output	0.8kW - 1.6kW



Smooth Cream



Smooth White

## Suite Finishes

Painted Surround  
Black interior

- 
- Smooth White
- 
- 
- Smooth Mist
- 
- 
- Smooth Cream

# ULTIFLAME PARADA ELITE

U-VR Inset Limestone Illumia Suite



Video



## Features

- Open fire experience
- LED surround lighting
- Customisable fuel effect
- Silver birch logs
- Crystal ash embers
- Single or dual colour flame
- LED brightness control
- Thermostatic remote & manual control operation
- Available in two sizes



## Specification

Suite Dimensions: mm	54" 58"	H-990 x W-1350 x D-400 H-990 x W-1464 x D-400
Heat Output	0.8kW - 1.6kW	

## Suite Finish

Natural  Limestone

# ULTIFLAME AVIGNON ELITE

U-VR Inset Limestone Suite



Video



## Features

- Open fire experience
- Customisable fuel effect
- Silver birch logs
- Crystal ash embers
- Single or dual colour flame
- LED brightness control
- Thermostatic remote & manual control operation
- Available in two sizes



## Specification

Suite Dimensions: mm	54" 58"	H-990 x W-1350 x D-380 H-990 x W-1464 x D-380
Heat Output	0.8kW - 1.6kW	

## Suite Finish

Natural  Limestone



# ULTIFLAME ALEESIA

U-VR Inset Limestone Illumia Suite



Video



## Features

- Glass Fronted Fire
- LED surround lighting
- Customisable fuel effect
- Silver birch logs
- Crystal ash embers
- Single or dual colour flame
- LED brightness control
- Thermostatic remote & manual control operation
- Available in two sizes



## Specification

Suite Dimensions: mm	54" 58"	H-1050 x W-1370 x D-400 H-1050 x W-1470 x D-400
Heat Output	0.8kW - 1.6kW	

## Suite Finish

Natural  Limestone

# ULTIFLAME ASENCIO

U-VR Inset Limestone Suite



Video



## Features

- Glass Fronted Fire
- Customisable fuel effect
- Silver birch logs
- Crystal ash embers
- Single or dual colour flame
- LED brightness control
- Thermostatic remote & manual control operation



## Specification

Suite Dimensions: mm	H-1095 x W-1376 x D-380	
Heat Output	0.8kW - 1.6kW	

## Suite Finish

Natural  Limestone

# ULTIFLAME ANGELO

U-VR Inset Limestone Suite



Video



## Features

- Open fire experience
- Customisable fuel effect
- Silver birch logs
- Crystal ash embers
- Single or dual colour flame
- LED brightness control
- Thermostatic remote & manual control operation



## Specification

Suite Dimensions: mm	H-995 x W-1300 x D-380
Heat Output	0.8kW - 1.6kW

## Suite Finish

Natural  Limestone

# ULTIFLAME BOTICELLI

U-VR Inset Limestone Suite



Video



## Features

- Open fire experience
- Customisable fuel effect
- Silver birch logs
- Crystal ash embers
- Single or dual colour flame
- LED brightness control
- Thermostatic remote & manual control operation



## Specification

Suite Dimensions: mm	H-980 x W-1280 x D-380
Heat Output	0.8kW - 1.6kW

## Suite Finish

Natural  Limestone

# ULTIFLAME PABLO

U-VR Inset Limestone Suite



Video



## Features

- Open fire experience
- Customisable fuel effect
- Silver birch logs
- Crystal ash embers
- Single or dual colour flame
- LED brightness control
- Thermostatic remote & manual control operation



## Specification

Suite Dimensions: mm	H-980 x W-1220 x D-410
Heat Output	0.8kW - 1.6kW

## Suite Finish

Natural  Limestone

# ULTIFLAME ELITE

U-VR Wall Inset



Video



## Features

- Open fire experience
- Customisable fuel effect
- Silver birch logs
- Crystal ash embers
- Single or dual colour flame
- LED brightness control
- Thermostatic remote & manual control operation



## Specification

Fire Dimensions: mm	H-352 x W-843 x D-182
Heat Output	0.8kW - 1.6kW

# ULTIFLAME VICHY

U-VR Wall Inset



Video



Satin Silver

## Features

- Open fire experience
- Customisable fuel effect
- Silver birch logs
- Crystal ash embers
- Single or dual colour flame
- LED brightness control
- Thermostatic remote & manual control operation



Black Textured



Satin Champagne



## Specification

Dimensions: mm	H-540 x W-1490 x D-71
Heat Output	0.8kW - 1.6kW

## Finishes

- Steel Fabricated Fascia
- Brushed Metallic or Black Textured Paint
- Satin Silver
- Satin Champagne
- Black Textured

# ULTIFLAME METZ

U-VR Wall Inset



Video



Satin Champagne

## Features

- Open fire experience
- Customisable fuel effect
- Silver birch logs
- Crystal ash embers
- Single or dual colour flame
- LED brightness control
- Thermostatic remote & manual control operation



Satin Silver



## Specification

Dimensions: mm	H-540 x W-1490 x D-22.5
Heat Output	0.8kW - 1.6kW

## Finishes

- Steel Fabricated Fascia
- Brushed Metallic
- Satin Silver
- Satin Champagne

# ULTIFLAME INSTINCT

U-VR Wall Inset



Video



Satin Champagne

## Features

- Open fire experience
- Customisable fuel effect
- Silver birch logs
- Crystal ash embers
- Single or dual colour flame
- LED brightness control
- Thermostatic remote & manual control operation



Satin Black



## Specification

Dimensions: mm	H-647 x W-1138 x D-60
Heat Output	0.8kW - 1.6kW

## Finishes

Steel Fabricated Fascia	Satin Champagne
Steel Fabricated Fascia Brushed Metallic	Satin Black

# ULTIFLAME EVORA ASENCIO & ASENCIO

U-VR Wall Inset



Video



Evora Asencio

## Features

- Glass fronted fire
- Customisable fuel effect
- Silver birch logs
- Crystal ash embers
- Single or dual colour flame
- LED brightness control
- Thermostatic remote & manual control operation



Asencio trimless installation



## Specification

Dimensions: mm	Evora Asencio H-768 x W-762 x D-19 Asencio H-759 x W-670 x D-183
Heat Output	0.8kW - 1.6kW

## Finish

Steel Fabricated Fascia Dual Metallic	Black Nickel & Chrome
--	-----------------------

Vader Aleesia Black Nickel & Black



## ULTIFLAME VADER ALEESIA & ALEESIA

U-VR Wall Inset

### Features

- Glass fronted fire
- Customisable fuel effect
- Silver birch logs
- Crystal ash embers
- Single or dual colour flame
- LED brightness control
- Thermostatic remote & manual control operation



Vader Aleesia Black Nickel & Chrome



Aleesia trimless installation



Video

### Specification

Dimensions: mm	Vader Aleesia H-683 x W-963 x D-21 Aleesia H-679 x W-870 x D-183
Heat Output	0.9kW – 1.8kW
Finishes Steel Fabricated Fascia Dual Metallic	Black Nickel & Black Black Nickel & Chrome

# ULTIFLAME CELENA

U-VR Wall Inset



Video



## Features

- Open fire experience
- Customisable fuel effect
- Silver birch logs
- Crystal ash embers
- Single or dual colour flame
- LED brightness control
- Thermostatic remote & manual control operation



## Specification

Fire Dimensions: mm	H-447 x W-560 x D-182
Heat Output	0.8kW - 1.6kW

# ULTIFLAME IMPULSE

U-VR Wall Inset



Video



Satin Silver

## Features

- Open fire experience
- Customisable fuel effect
- Silver birch logs
- Crystal ash embers
- Single or dual colour flame
- LED brightness control
- Thermostatic remote & manual control operation



## Specification

Dimensions: mm	H-742 x W-860 x D-60
Heat Output	0.8kW - 1.6kW



Satin Black

## Finishes

Steel Fabricated Fascia	Satin Silver
Brushed Metallic	Satin Black

# ULTIFLAME ARCADIA

U-VR Hearth Inset



Video



Black & Gold

## Features

- Open fire experience
- Customisable fuel effect
- Silver birch logs
- Crystal ash embers
- Single or dual colour flame
- LED brightness control
- Thermostatic remote & manual control operation



## Optional Extras

75mm Spacer frame  
For flat wall installation



Black & Chrome

## Specification

Dimensions: mm	H-612 x W-528 x D-154
Heat Output	0.75kW - 1.5kW

## Finishes

High Quality Cast Iron Fascia  
Paint and Metallic Plated



# ULTIFLAME DECADENCE

U-VR Hearth Inset



Video



Chrome

## Features

- Open fire experience
- Customisable fuel effect
- Silver birch logs
- Crystal ash embers
- Single or dual colour flame
- LED brightness control
- Thermostatic remote & manual control operation



## Optional Extras

75mm Spacer frame  
For flat wall installation



Gold

Black Nickel

## Specification

Dimensions: mm	H-630 x W-528.5 x D-151
Heat Output	0.75kW - 1.5kW

## Finishes

High Quality Cast Iron Fascia  
Metallic Plated





# ULTIFLAME CAMBER

U-VR Hearth Inset



Video



Satin Silver

## Features

- Open fire experience
- Customisable fuel effect
- Silver birch logs
- Crystal ash embers
- Single or dual colour flame
- LED brightness control
- Thermostatic remote & manual control operation



## Optional Extras

75mm Spacer frame  
For flat wall installation



Satin Champagne

Black Textured

## Specification

Dimensions: mm	H-619 x W-537 x D-135
Heat Output	0.75kW – 1.5kW

## Finishes

Anodised Aluminium Fascia  
Brushed Metallic or  
Black Textured Paint

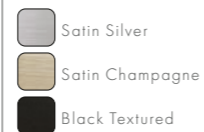

# ULTIFLAME FRONTIER

U-VR Hearth Inset



Video



## Features

- Open fire experience
- Customisable fuel effect
- Silver birch logs
- Crystal ash embers
- Single or dual colour flame
- LED brightness control
- Thermostatic remote & manual control operation



## Optional Extras

75mm Spacer frame  
For flat wall installation

## Specification

Dimensions: mm	H-617 x W-541 x D-131
Heat Output	0.75kW – 1.5kW

## Finish

Steel Fabricated Fascia  
Dual Finish  
Paint & Metallic

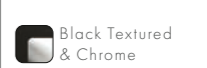

# ULTIFLAME ESSENCE

U-VR Hearth Inset



Video



Satin Brass

## Features

- Open fire experience
- Customisable fuel effect
- Silver birch logs
- Crystal ash embers
- Single or dual colour flame
- LED brightness control
- Thermostatic remote & manual control operation



## Optional Extras

75mm Spacer frame  
For flat wall installation



Satin Silver

Black

## Specification

Dimensions: mm	H-619 x W-537 x D-127
Heat Output	0.75kW - 1.5kW

## Finishes

Steel Fabricated Fascia  
Brushed Metallic  
Smooth Black Paint

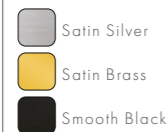

# ULTIFLAME DESIGNER

U-VR Hearth Inset



Video



Black Nickel & Chrome

## Features

- Open fire experience
- Customisable fuel effect
- Silver birch logs
- Crystal ash embers
- Single or dual colour flame
- LED brightness control
- Thermostatic remote & manual control operation



## Optional Extras

75mm Spacer frame  
For flat wall installation



Chrome & Black

## Specification

Dimensions: mm	H-599 x W-498 x D-129
Heat Output	0.75kW - 1.5kW

## Finishes

Steel Fabricated Fascia  
Dual Metallic



# ULTIFLAME ENDURA

U-VR Hearth Inset



Video



Chrome

## Features

- Open fire experience
- Customisable fuel effect
- Silver birch logs
- Crystal ash embers
- Single or dual colour flame
- LED brightness control
- Thermostatic remote & manual control operation



## Optional Extras

75mm Spacer frame  
For flat wall installation



Black

## Finishes

Steel Fabricated Fascia  
Metallic or Smooth Black Paint

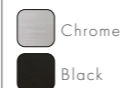

## Specification

Dimensions: mm	H-598 x W-497 x D-126
Heat Output	0.75kW - 1.5kW

# ULTIFLAME CONTEMPORARY

U-VR Hearth Inset



Video



Satin Silver

## Features

- Open fire experience
- Customisable fuel effect
- Silver birch logs
- Crystal ash embers
- Single or dual colour flame
- LED brightness control
- Thermostatic remote & manual control operation



## Optional Extras

75mm Spacer frame  
For flat wall installation



Satin Champagne

## Finishes

Steel Fabricated Fascia  
Brushed Metallic



## Specification

Dimensions: mm	H-598 x W-493 x D-132
Heat Output	0.75kW - 1.5kW

# PURAFLAME PANORAMIC

Wall Outset



Video



## Features

- Ultra High Technology Experience
- Glass fronted fire
- Convincing real flame effects
- Exceptional functionality
- Thermostatic remote & manual control operation
- Contemporary flat glass styling
- Includes wall fixing bracket

Hot coal embers fuel effect



## Specification

Dimensions: mm	H-400 x W-1080 x D-105
Heat Output	1.0kW - 2.0kW

## Finish

Black Glass

# PURAFLAME® – FUNCTIONALITY AT YOUR FINGERTIPS

THE MOST FUNCTIONAL ELECTRIC FIRES ON THE MARKET



## MULTI FLAME PICTURES

Celsi has patented some of the most advanced technologies to create the most sophisticated and realistic fire effect in the world. The Puraflame fire has been designed to give the appearance of outstanding depth along with an amazing 3D effect, and comes with a selection of real fire effects to choose from.



SMOULDERING LOG



BLAZING LOG



FLAMING COAL



Flame pictures are extremely quiet running when operated in isolation and no heat is required from the appliance.



## FLAME SPEED

You may prefer a slow and calming flame or a quick and spellbinding flicker. With a choice of 5 flame speeds you can speed up or slow down each of the real fire movies.



## FIRE VOLUME

There's nothing more soothing than the authentic crackle of a real log fire. Lower the volume for a more subtle result or crank it up for full effect. There is also a mute button to silence the sound effect when you need to. When on 'flame only' setting, Puraflame is the quietest fire on the market.



## MOOD LIGHTS

The mood lighting feature creates a calming ambience around the heater. A choice of 3 LED colours: white, amber and blue, lets you highlight the fire to suit your mood.



## BRIGHTNESS

Natural daylight or artificial lamplight can have a big impact on how you see the flame picture. We have included this brightness function to allow you the option to increase or dim the LCD screen brightness to suit you and your environment.



## SLEEP TIMER

An extremely practical function. The sleep timer can be used to automatically turn the heater to standby mode after a predetermined amount of time. Great if you want to doze off and not worry about turning the fire off once you have fallen asleep. The timer can be set for up to a maximum of 4 hours in 30 minute intervals and once this time has elapsed the appliance will automatically go into standby.



## THERMOSTATIC HEATING

The fan heater can be operated in manual or automatic mode. When in manual mode you can use the heat button on the remote handset to select low heat, high heat or heat off. To eliminate the hassle of constantly manually adjusting the heat output, every Puraflame fire features a digitally controlled thermostat. Use the temperature function to turn on automatic heat mode. You can pre-select your comfort level and the heater will automatically adjust between high heat and off, maintaining the selected room temperature level.

# FLAMONIK RAPTURE

Wall Outset



Video



## Features

- Flat glass fascia
- Distinctive flame effect
- Raised log fuel bed
- Thermostatic remote & manual control operation
- Includes wall fixing bracket



## Specification

Dimensions: mm	H-440 x W-686 x D-110
Heat Output	0.75kW - 1.5kW

# FLAMONIK ENCHANT

Wall Outset



Video



## Features

- Curved glass fascia
- Enchanting smoky flame effect
- Raised log fuel bed
- Thermostatic remote & manual control operation
- Includes wall fixing bracket



## Specification

Dimensions: mm	H-441 x W-916 x D-126
Heat Output	0.75kW - 1.5kW



## Finish

Black Glass



## Finish

Black Glass

# ACCENT TRADITIONAL

Hearth Inset



Video



Brass

## Features

- Lively Ribbon Flame Effect
- Coal effect fuel bed
- 3 LED flame brightness settings
- Thermostatic remote & manual control operation



Chrome

## Finishes

Steel Fabricated  
Metallic Plated Trim

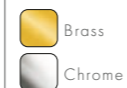

## Specification

Dimensions: mm	H-595 x W-490 x D-35
Heat Output	1.0kW - 2.0kW

# ACCENT INFUSION

Hearth Inset



Video



Chrome & Satin Silver

## Features

- Lively Ribbon Flame Effect
- Coal effect fuel bed
- 3 LED flame brightness settings
- Thermostatic remote & manual control operation



Brass & Black



Black & Chrome

## Finishes

Steel Fabricated Fascia  
Dual Metallic & Painted

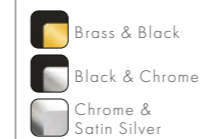

## Specification

Dimensions: mm	H-595 x W-498x D-83
Heat Output	1.0kW - 2.0kW

# ELECTRIFLAME PRESTIGE

E-XD Wall Outset

## Features

- Glass fronted fire
- High definition effect
- Extra deep 3D coals
- Relaxing smoky flames
- LED brightness control
- Thermostatic remote & manual control operation
- Includes wall fixing bracket



Atmospheric flame ascension



## Specification

Dimensions: mm	H-600 x W-1100 x D-150
Heat Output	0.75kW - 1.5kW
Finish Natural Marble	 Prestige Brown



Video

# ELECTRIFLAME BLACK GLASS

E-XD Wall Outset



Video



## Features

- Glass fronted fire
- High definition effect
- Extra deep 3D coals
- Relaxing smoky flames
- LED brightness control
- Thermostatic remote & manual control operation
- Includes wall fixing bracket
- Available in two sizes



## Specification

Dimensions: mm	H-600 x W-1300 & 1100 x D-126
Heat Output	0.75kW - 1.5kW

## Finish



# ELECTRIFLAME ROYAL BOTTICINO

E-XD Wall Outset



Video



## Features

- Glass fronted fire
- High definition effect
- Extra deep 3D coals
- Relaxing smoky flames
- LED brightness control
- Thermostatic remote & manual control operation
- Includes wall fixing bracket



## Specification

Dimensions: mm	H-600 x W-1100 x D-150
Heat Output	0.75kW - 1.5kW

## Finish

Natural Marble





## ELECTRIFLAME TRAVERTINE

E-XD Wall Outset



Video



### Features

- Glass fronted fire
- High definition effect
- Extra deep 3D coals
- Relaxing smoky flames
- LED brightness control
- Thermostatic remote & manual control operation
- Includes wall fixing bracket
- Available in two sizes



### Specification

Dimensions: mm	H-600x W-1300 & 1100x D-150
Heat Output	0.75kW - 1.5kW

### Finish

Natural	Travertine
---------	------------

## ELECTRIFLAME PIANO BLACK

E-XD Wall Outset



Video



### Features

- Glass fronted fire
- High definition effect
- Extra deep 3D coals
- Relaxing smoky flames
- LED brightness control
- Thermostatic remote & manual control operation
- Includes wall fixing bracket
- Available in two sizes



### Specification

Dimensions: mm	H-600x W-1300 & 1100x D-150
Heat Output	0.75kW - 1.5kW

### Finish

Glossy Painted	Black
----------------	-------

# ELECTRIFLAME CAMBER

E-XD Hearth Inset



Video



Satin Champagne

## Features

- Glass fronted fire
- Customisable fuel effect
- Silver birch logs
- Crystal ash embers
- Single or dual colour flame
- LED brightness control
- Thermostatic remote & manual control operation



## Optional Extras

75mm Spacer frame  
For flat wall installation



Satin Silver

Black Textured

## Finishes

Anodised Aluminium Fascia  
Brushed Metallic  
Textured Black Paint

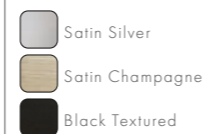

## Specification

Dimensions: mm	H-619 x W-537 x D-105
Heat Output	0.75kW - 1.5kW

# ELECTRIFLAME DECADENCE

E-XD Hearth Inset



Video



Gold

## Features

- Glass fronted fire
- Customisable fuel effect
- Silver birch logs
- Crystal ash embers
- Single or dual colour flame
- LED brightness control
- Thermostatic remote & manual control operation



## Optional Extras

75mm Spacer frame  
For flat wall installation



Chrome

Black Nickel

## Finishes

High Quality Cast Iron Fascia  
Metallic Plated

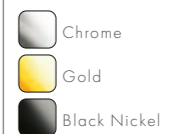

## Specification

Dimensions: mm	H-630 x W-528.5 x D-122
Heat Output	0.75kW - 1.5kW

# ELECTRIFLAME ESSENCE

E-XD Hearth Inset



Video



Antique Brass

## Features

- Glass fronted fire
- Customisable fuel effect
- Silver birch logs
- Crystal ash embers
- Single or dual colour flame
- LED brightness control
- Thermostatic remote & manual control operation



## Optional Extras

75mm Spacer frame  
For flat wall installation



Satin Silver Satin Brass Black

## Specification

Dimensions: mm	H-610 x W-537 x D-105
Heat Output	0.75kW – 1.5kW

## Finishes

Steel Fabricated Fascia  
Brushed Metallic  
or Smooth Black Paint



# ELECTRIFLAME ARCADIA

E-XD Hearth Inset



Video



Black & Chrome

## Features

- Glass fronted fire
- Customisable fuel effect
- Silver birch logs
- Crystal ash embers
- Single or dual colour flame
- LED brightness control
- Thermostatic remote & manual control operation



## Optional Extras

75mm Spacer frame  
For flat wall installation



Black & Gold

## Specification

Dimensions: mm	H-612 x W-528 x D-130
Heat Output	0.75kW – 1.5kW

## Finishes

High Quality Cast Iron Fascia  
Dual Metallic Plated

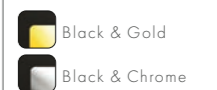

Black Nickel & Black



## ELECTRIFLAME SIGNATURE

E-XD Hearth Inset

### Features

- Glass fronted fire
- Customisable fuel effect
- Silver birch logs
- Crystal ash embers
- Single or dual colour flame
- LED brightness control
- Thermostatic remote & manual control operation



THERMO-  
STATIC



7 DAY  
TIMER



ENERGY  
SAVING



ISO  
FLAME



FLAME  
FUSION

### Optional Extras

75mm Spacer frame  
For flat wall installation



Satin Silver & Chrome



Video

### Specification

Suite Dimensions: mm	H-599 x W-498 x D-129
Heat Output	0.75kW - 1.5kW
Finishes	<input checked="" type="checkbox"/> Black Nickel & Black <input type="checkbox"/> Satin Silver & Chrome
Steel Fabricated Fascia	
Dual Metallic	

# ELECTRIFLAME DAISY

E-XD Hearth Inset



Video



Satin Silver

## Features

- Glass fronted fire
- Customisable fuel effect
- Silver birch logs
- Crystal ash embers
- Single or dual colour flame
- LED brightness control
- Thermostatic remote & manual control operation



## Optional Extras

75mm Spacer frame  
For flat wall installation



Brass

Black

## Finishes

Steel Fabricated Trim  
Solid Brass or Cast Iron Fret  
Metallic or Smooth Black Paint



## Specification

Dimensions: mm	H-595 x W-490 x D-100
Heat Output	0.75kW - 1.5kW

# ELECTRIFLAME CARESS

E-XD Hearth Inset



Video



Satin Silver

## Features

- Glass fronted fire
- Customisable fuel effect
- Silver birch logs
- Crystal ash embers
- Single or dual colour flame
- LED brightness control
- Thermostatic remote & manual control operation



## Optional Extras

75mm Spacer frame  
For flat wall installation



Brass

## Finishes

Quality Cast Trim and Fret  
Solid Brass or Cast Iron  
Black paint detail



## Specification

Dimensions: mm	H-650 x W-535 x D-100
Heat Output	0.75kW - 1.5kW

# ELECTRIFLAME BAUHAUS

E-XD Hearth Inset

## Features

- Glass fronted fire
- Customisable fuel effect
- Silver birch logs
- Crystal ash embers
- Single or dual colour flame
- LED brightness control
- Thermostatic remote & manual control operation



## Optional Extras

75mm Spacer frame  
For flat wall installation



Brass



Chrome



Black

## Finishes

Steel Fabricated Trim  
Solid Brass or Cast Iron Fret  
Metallic or Smooth Black Paint

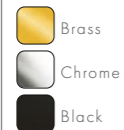

## Specification

Dimensions: mm	H-595 x W-490 x D-100
Heat Output	0.75kW - 1.5kW



Video

Metal 2



## ELECTRISTOVE METAL 1 & 2

E-XD Outset Stove

### Features

- Tough steel body & door
- High definition effect
- Extra deep 3D coals
- Relaxing smoky flames
- LED brightness control
- Thermostatic remote & manual control operation



Metal 1



METAL 2  
Video

### Specification

Dimensions: mm	Metal 1	H-579 x W-430 x D-332
	Metal 2	H-587 x W-524 x D-295
Heat Output	1.0kW – 2.0kW	
Finish	Black	
Steel Fabricated Body		



METAL 1  
Video

# ELECTRISTOVE GLASS 1 & 2

E-XD Outset Stove

## Features

- Tough steel body
- Glass door & stove top
- High definition effect
- Extra deep 3D coals
- Relaxing smoky flames
- LED brightness control
- Thermostatic remote & manual control operation



Glass 2



GLASS 2  
Video



Glass 1

## Specification

Dimensions: mm	Glass 1	H-583 x W-430 x D-334
	Glass 2	H-591 x W-524 x D-295
Heat Output	1.0kW - 2.0kW	
Finish	Black Glass & Chrome	
Steel Fabricated Body		
Glass Door		



GLASS 1  
Video



ELECTRIFLAME® VR

Outset Suites - 6-15

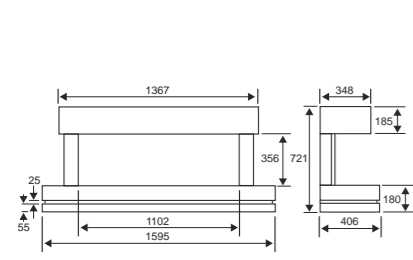

**VOLARE 1100 ILLUMIA**

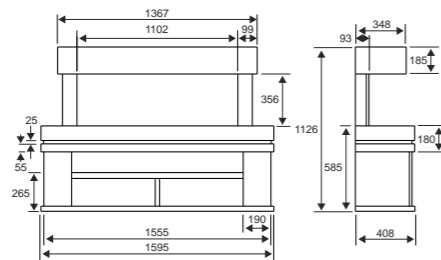

**MEDIA 1100 ILLUMIA**

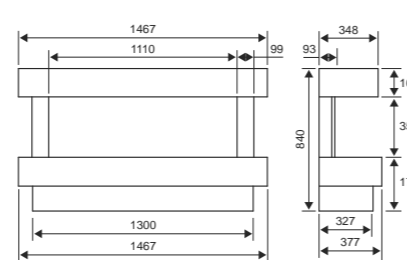

**CARINO 1100 ILLUMIA**

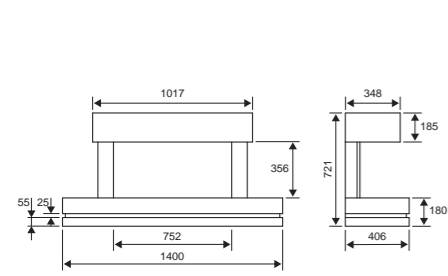

**VOLARE 750 ILLUMIA**

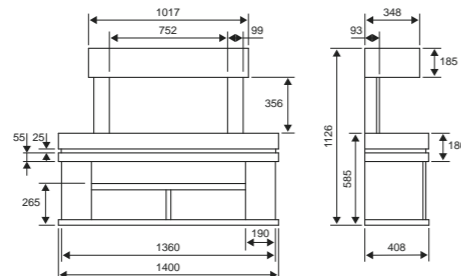

**MEDIA 750 ILLUMIA**

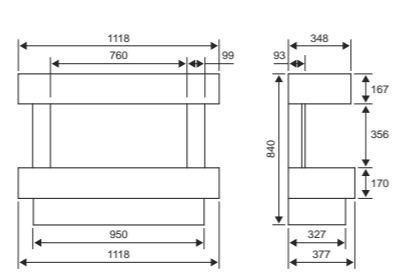

**CARINO 750 ILLUMIA**

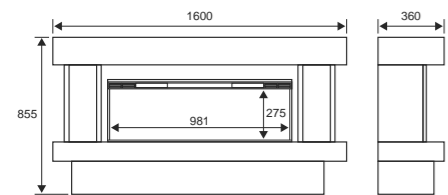

**ORBITAL 1000 ILLUMIA**

Wall Outset - 16-22

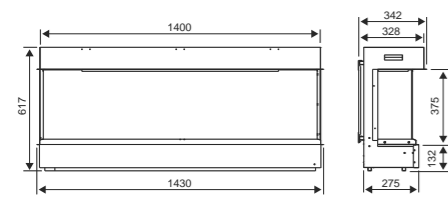

**1400**

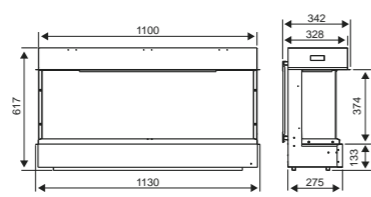

**1100**

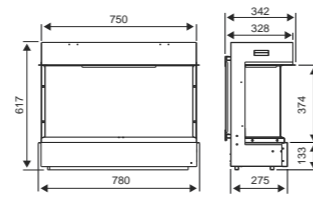

**750**

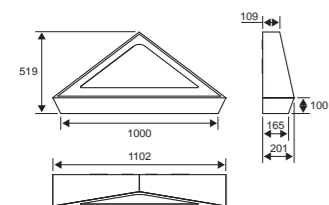

**LOUVRE**

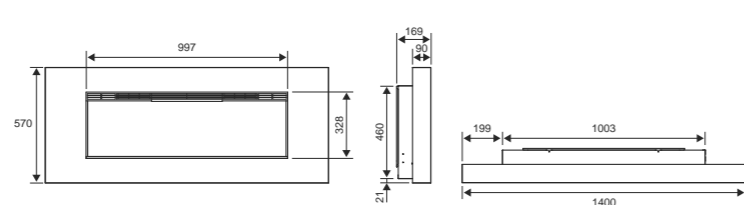

**BASILICA**

ELECTRIFLAME® VR

Wall Inset - 23-25

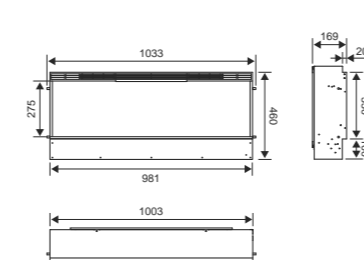

**COMMODUS**

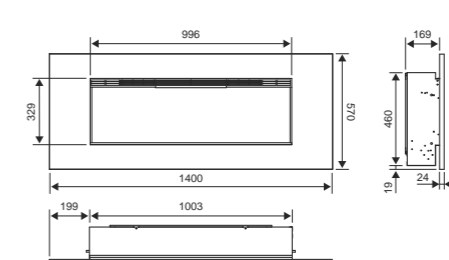

**METZ**

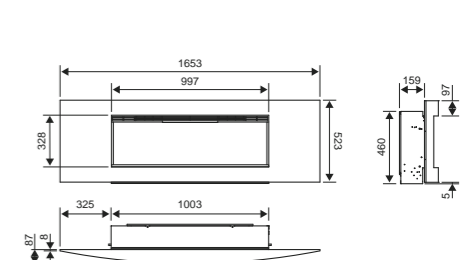

**VICHY**

Hearth Inset - 26-29

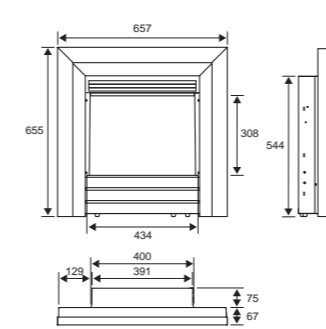

**ACERO**

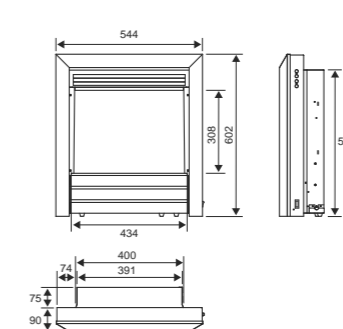

**PARRILLA**

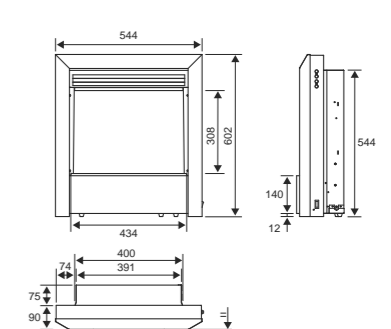

**CONTEMPORARY**

ELECTRISTOVE® VR

Outset Stoves - 30-33

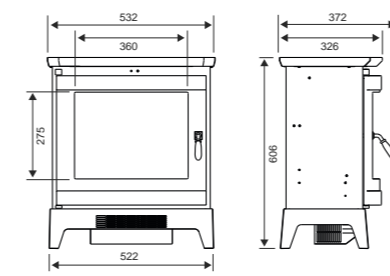

**ROCHESTER**

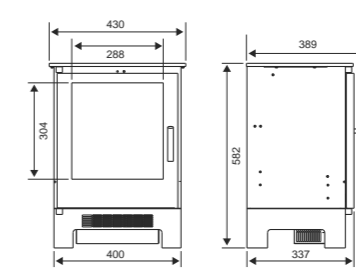

**ARUNDEL**

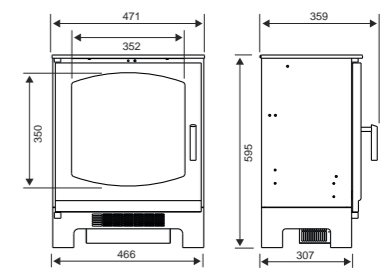

**LUXIMA**

ULTIFLAME® VR

Outset Suites - 34-45

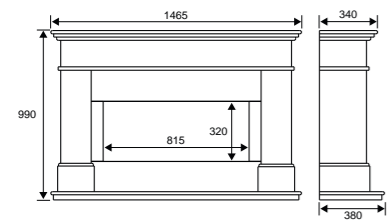

ADOUR ELITE ILLUMIA

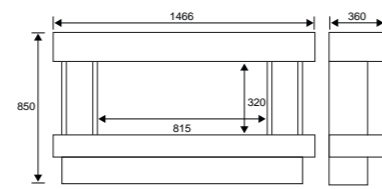

ORBITAL 800 ILLUMIA

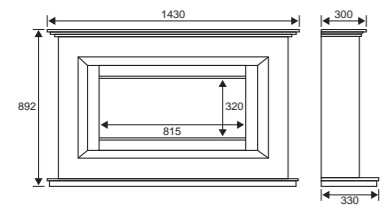

VEGA

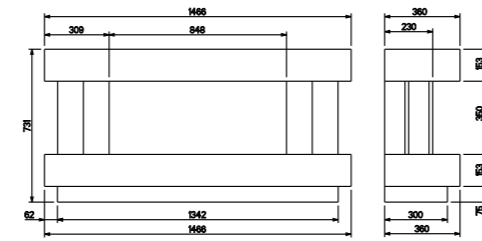

GEMMA 800 ILLUMIA

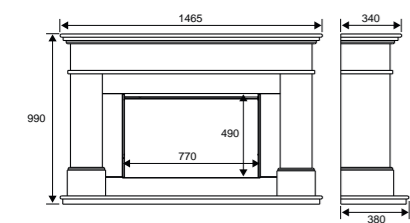

ADOUR ALEESIA ILLUMIA

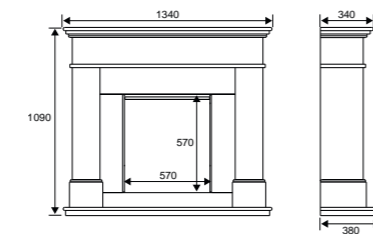

ADOUR ASENCIO ILLUMIA

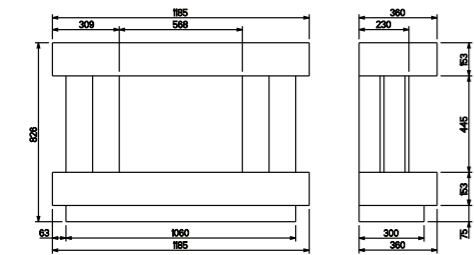

GEMMA 600 ILLUMIA

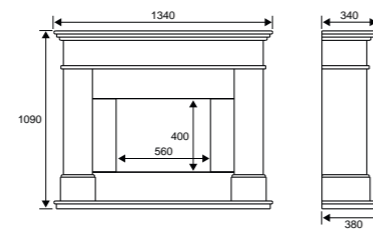

ADOUR ILLUMIA

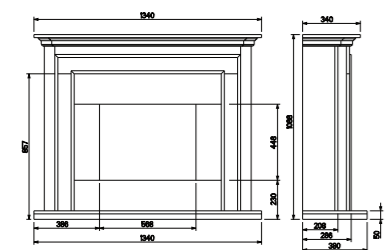

CANELO ILLUMIA

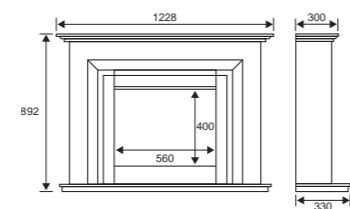

ELARA

Inset Limestone Suites - 46-52

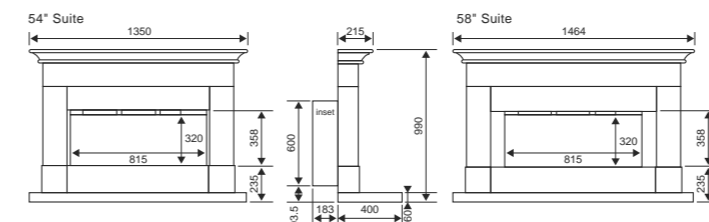

PARADA ELITE ILLUMIA

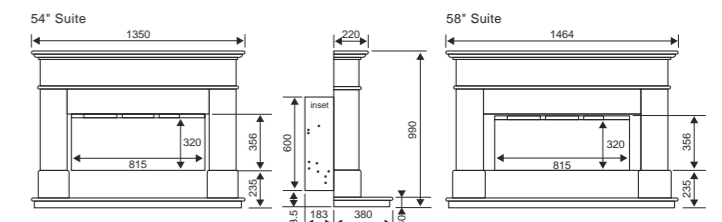

AVIGNON ELITE

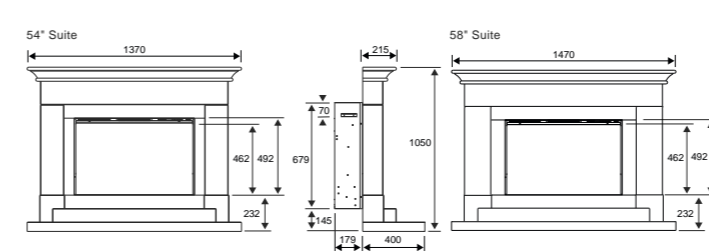

ALEESIA ILLUMIA

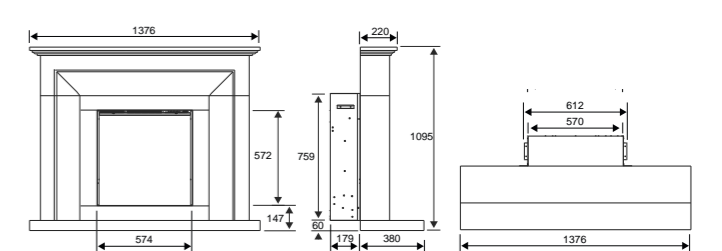

ASENCIO

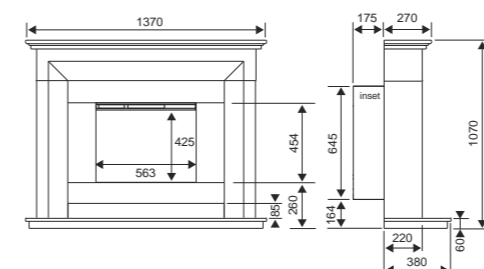

ANGELO

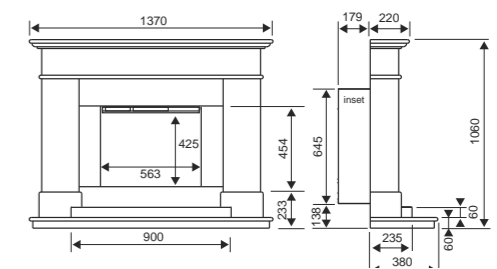

BOTICELLI

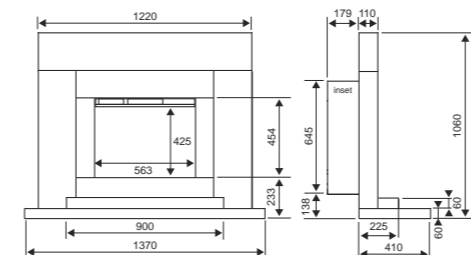

PABLO

ULTIFLAME® VR

Wall Inset - 53-61

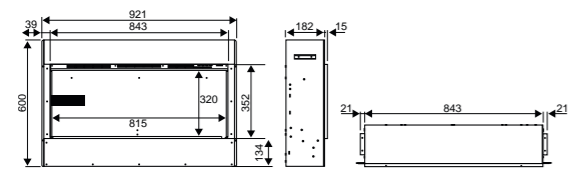

ELITE

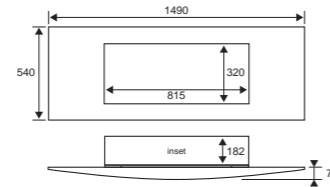

VICHY

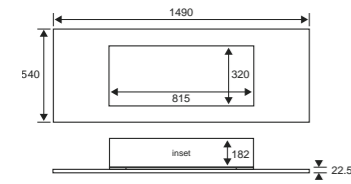

METZ

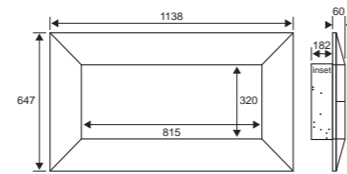

INSTINCT

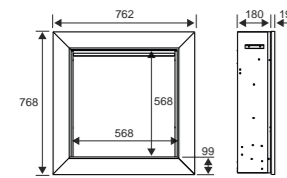

EVORA ASENCIO

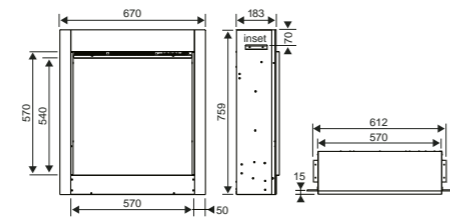

ASENCIO

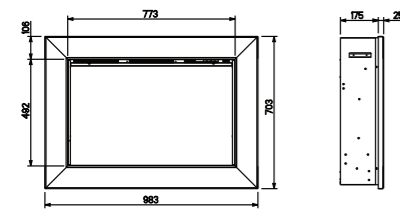

VADER ALEESIA

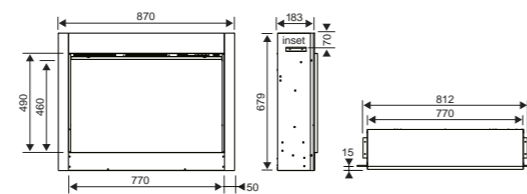

ALEESIA

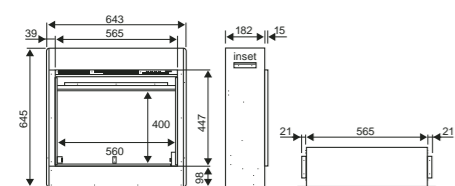

CELENA

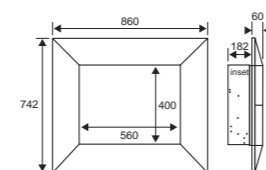

IMPULSE

Hearth Inset - 62-69

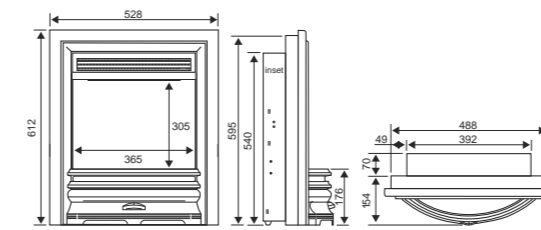

ARCADIA

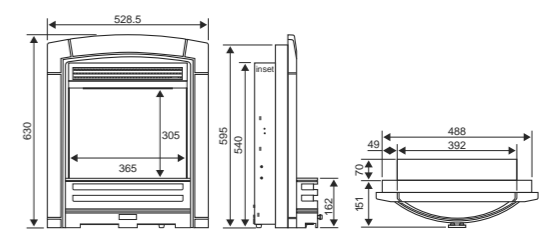

DECADENCE

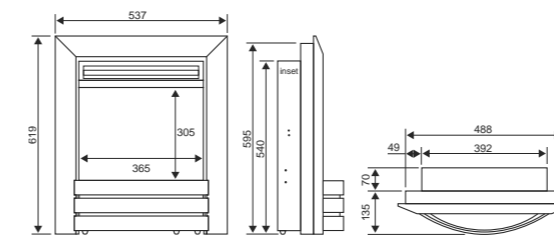

CAMBER

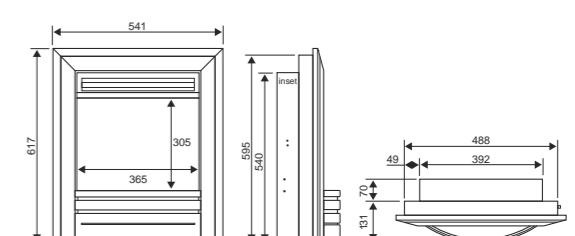

FRONTIER

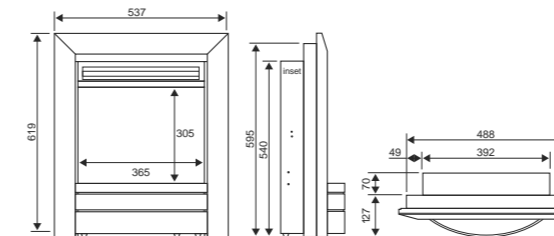

ESSENCE

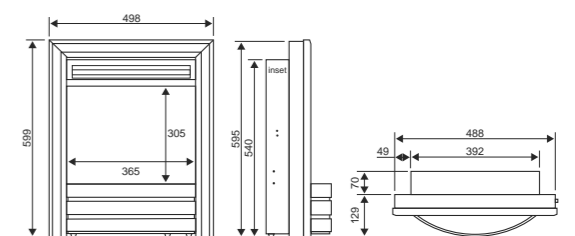

DESIGNER

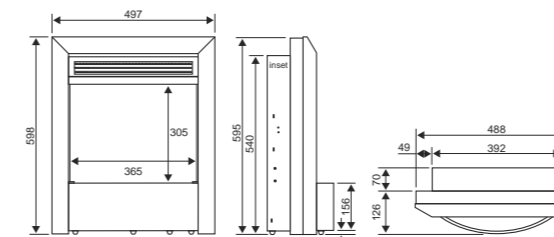

ENDURA

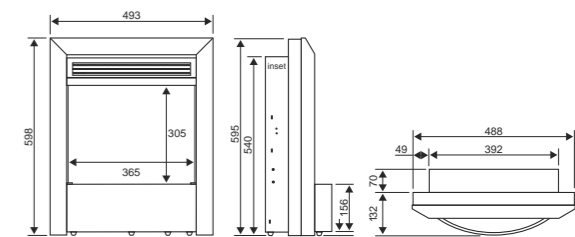

CONTEMPORARY

PURAFLAME

Wall Outset - 70-71

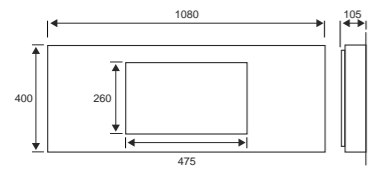

PANORAMIC

FLAMONIK

Wall Outset - 72-73

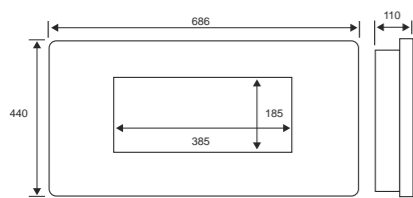

RAPTURE

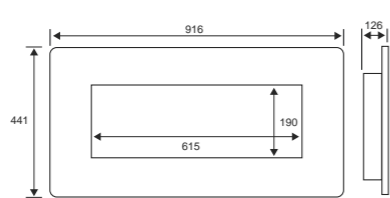

ENCHANT

ACCENT

Hearth Inset - 74-75

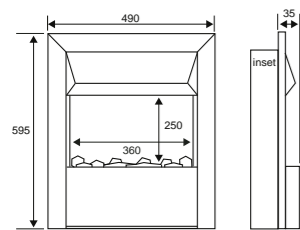

ACCENT TRADITIONAL

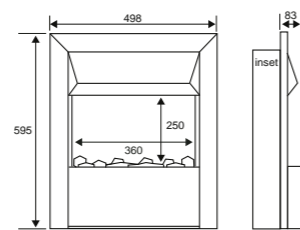

ACCENT INFUSION

ELECTRIFLAME® XD

Wall Outset - 76-81

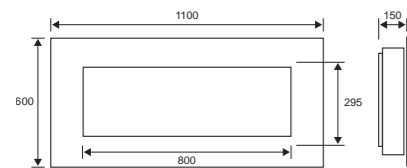

PRESTIGE

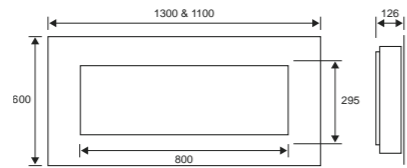

BLACK GLASS

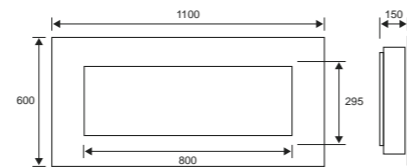

ROYAL BOTTICINO

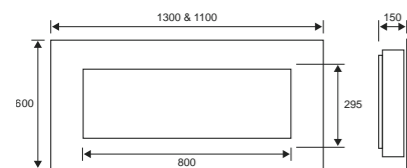

TRAVERTINE

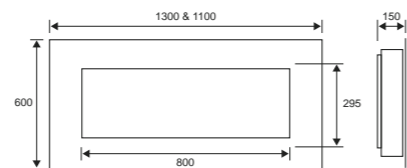

PIANO BLACK

ELECTRIFLAME® XD

Hearth Inset - 82-91

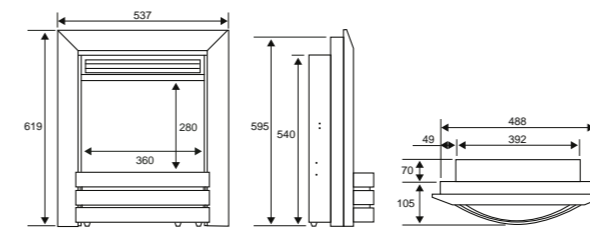

CAMBER

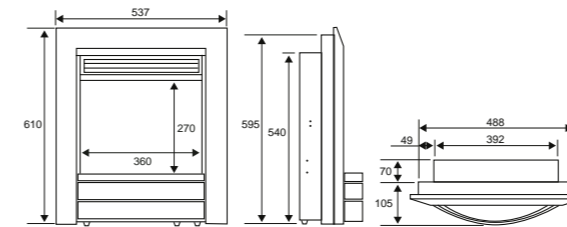

ESSENCE

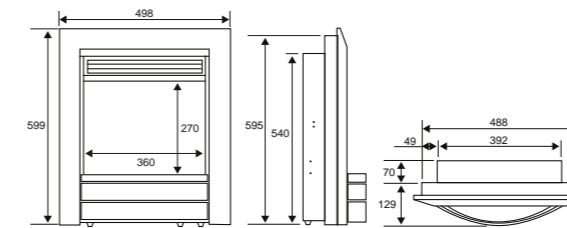

SIGNATURE

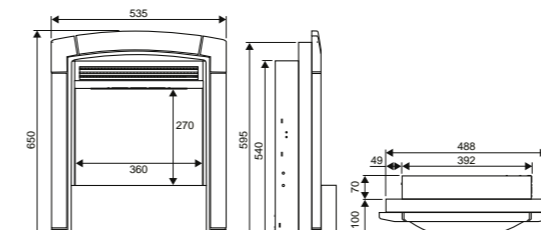

CARESS

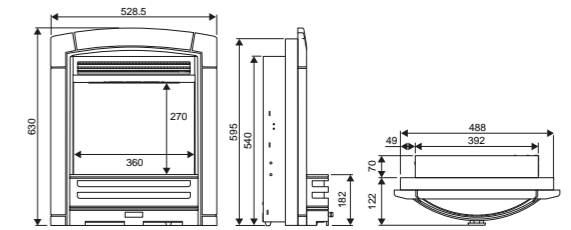

DECADENCE

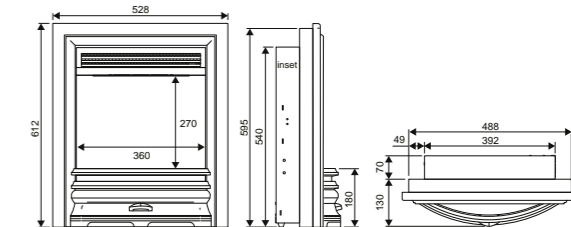

ARCADIA

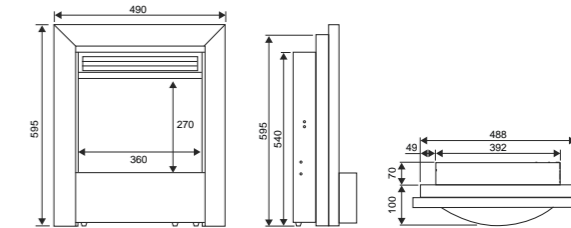

DAISY

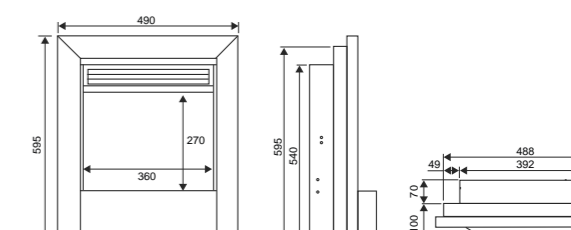

BAUHAUS

ELECTRISTOVE® XD

Outlet Stoves - 92-95

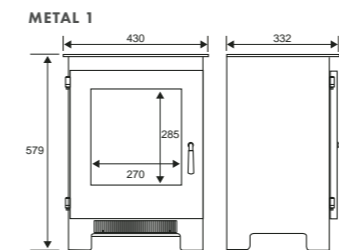

ELECTRISTOVE METAL

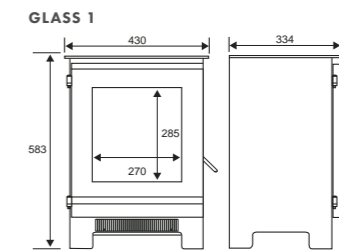
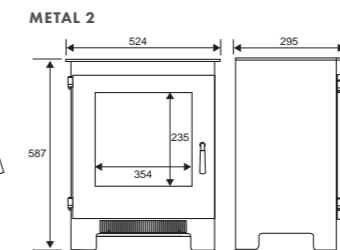

ELECTRISTOVE GLASS

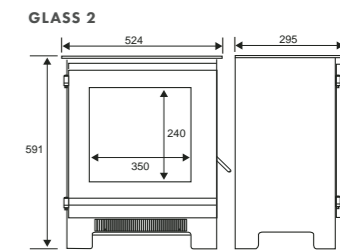



#### DISCLAIMER

Our policy is one of constant development and improvement. We therefore reserve the right to revise designs and specifications of our products without formal notice, patents pending. We always recommend our products be viewed in an approved showroom before purchase. Whilst we have taken every care in the preparation of this brochure it is not intended to replace the installation manual which provides more detailed information.

Photography is for illustration purposes only and although every effort has been made to ensure accurate reproduction of typical installations and flame pictures they may vary according to fire model and flue types.

We accept no liability for any loss or damage arising directly or indirectly from the use of this brochure.

We recommend that all our fires are used in conjunction with central heating and not as a primary source of heat.

In the interests of personal safety a suitable fireguard is recommended when children, the elderly and the infirm are present.

This brochure is copyright 2021 and must not be reproduced in whole or in any part without prior written permission.



**BFM Europe**  
BRITISH FIRE MANUFACTURERS

BFM Europe Ltd, Gordon Banks Drive,  
Trentham Lakes, Stoke-on-Trent ST4 4TJ

Tel: 01782 339000

Email: [sales@bfm-europe.com](mailto:sales@bfm-europe.com)

[www.celsielectricfires.co.uk](http://www.celsielectricfires.co.uk)

Go direct to the Celsi website on your smart phone or tablet device and use the app to scan the black and white QR codes shown on each page. Alternatively, go to [www.celsielectricfires.co.uk](http://www.celsielectricfires.co.uk) to browse all Celsi electric fires.

