



CELSI 
...the future of fire



PREMIUM ELECTRIC FIRES COLLECTION 2023





WELCOME TO CELSI

At Celsi we know how important it is to create a stylish and relaxing living environment. That's why we've developed this collection of premium electric fires.

I believe our success stems from a combination of innovative design, investment in technology and the highest quality manufacturing standards. To reflect my belief in their quality and durability, Celsi fires carry a minimum of 2 years guarantee, with some models extended by a further 3 years warranty.

This brochure has been designed to make the purchase of your new Celsi heater as simple as possible. I hope you find it both informative and inspiring.

Richard Jones

There is no more versatile fuel for home heating than electricity

With a range that includes beautifully crafted electric suites, feature wall smart fires, classically styled hearth inset fires, and contemporary stove designs, there is a Celsi fire to suit any home. Best of all you are free to enjoy any of these fantastic heating appliances in any room in your home simply by plugging into the nearest mains socket.

To learn more about the features and benefits of owning a Celsi electric fire please sit back and take a few moments to look through our Advanced Features section, along with our technology introduction to assist you in choosing your perfect Celsi fire experience.

ADVANCED FEATURES



THERMOSTATIC HEATING
Pre-set your heat comfort level for automatic temperature control via the handset.



TIMER FUNCTION
Programmable 7-day heating timer with hourly on/off control.
Up to 8 hrs sleep timer facility available on some models.



LED EFFICIENCY
Flame picture, fuel bed brightness, mood lighting, our onboard LED's ensure effective energy saving low power consumption.



ISOFLAME
Independent flame effect capable of displaying in isolation when no heat is required from the appliance.



REAL WOOD
100% Real Wood Logs, natural, authentic, and unique. Accept no imitations!



FLAME FUSION
A captivating fusion of soft and natural yellow flames with an attractive flare of blue flame intensity.



COLOUR CYCLE
Fix your favourite or go dynamic as you cycle through an array of impressive colour changing options.



COLOUR SMART
16 colour vibrant presets with 100+ options to customise the light ambience on flames, logs, and ember beds.



MOOD LIGHTS
An ambient stream of colour-rich LED back lighting. Colours to compliment warm and cool interiors, or simply to suit your mood.



CELSI SMART APP
Control your Smart fire or stove from your phone or tablet with full handset functionality. Voice control Alexa and Google Assistant compatible.



Visit App Store or Google Play Store

Scan QR code to download app.



5 year warranty provides 2 years full guarantee and 3 years parts only. Only applicable to electric fire engines.

Fire Surrounds and Fascias are subject to 12 months guarantee.



Compliance with Electrical Energy Rated Product (ERP) Integrated design features for optimal energy saving performance and assurance.



Conformity assessed and certified UK & EU



SUITES Real Wood U-VR Luminaire 800

BUILT-IN FIRES E-VR Commodus Smart fires 1000/1250/1600

WALL FIRES U-VR Vader Aleesia

HEARTH FIRES U-VR Camber Satin Silver

STOVES E-H3D Hologram Genesis

Virtual Reality – Smart & Advanced Flame Projection



Advanced Flame Projection, and Holographic 3D Technologies simulate totally natural log fire effects. Smart connectivity, colours, and configuration raise the appearance and functionality of these electric fires and stoves to new levels.

Smart Functionality 6-7. 3D Hologram Stove 42-43

Virtual Reality – True Flame Experience



Open and Glass fronted technology with 'Real Wood Logs', or natural log effects. Incredible illusions of 'Active Blazing Embers' and intense flame captivation. Styles include luxury Limestone Suites, beautiful wall and hearth inset models, all designed to look sensational and create comfortable controllable warmth.

Real Wood Feature 52-53

Xtra Dimensional – High Definition Fire



Glass Fronted, extra deep fuel effect with high definition 3D flames. The E-XD range features impressive 'hang-on-the-wall' fires framed with Marble, Limestone, Premier board, and Glass fascia's.

Our hearth inset fires and stoves provide a wide selection of designs that complement both modern and traditional home interiors.

Inspired Flame Effect Technologies



Through illusion and LED light technology beautiful flames emerge to provide a range of distinctive electric fire effects that bewilder and excite.

CELSI SMART	Freestanding Suites - 3 Sided Glass	
	E-VR Quantum s1250/s1000	8-9
	E-VR Casino s1250/s1000	10-11
	E-VR Media 1100/750	12-13
	E-VR Carino 1100/750	14-15
	E-VR Gemma 1000	16-17
	E-VR Orbital 1000	18-19
CELSI SMART	Built-In Fires - 3 Sided Glass	
	E-VR Commodus s1600	20-21
	E-VR Commodus s1250	22-23
	E-VR Commodus s1000	24-25
	E-VR 1400	26-27
	E-VR 1100	28-29
	E-VR 750	30
	Wall Mounted Suites - 3 Sided Glass	
	E-VR Volare 750/1100	31-33
	Wall Inset Fires	
	E-VR Commodus	34-35
	Wall Mounted Fires	
	E-VR Louvre	36
	E-VR Basilica	37
	Hearth Inset Fires	
	E-VR Acero	38-39
	E-VR Parrilla	40-41
CELSI SMART	Stoves	
	H3D Hologram Genesis	42-43
	E-VR Spectre	44-45
	E-VR Stratford	46-47
	E-VR Rochester	48-49
	E-VR Arundel	50
	E-VR Luxima	51

REAL WOOD	Firebeam Suites	
	U-VR Firebeam 800/600/800XL/600XL	54-61
REAL WOOD	Freestanding Suites	
	U-VR Luminaire 800/600	62-63
	U-VR Skyfall 800/600	64-67
	U-VR Orbital 800	69
	U-VR Vega	70
	U-VR Gemma 800/600	71-72
	U-VR Adour Aleesia/Adour Elite/Adour Asencio/Adour	73-77
	U-VR Canelo	78
	U-VR Elara	79
	Limestone Inset Suites	
	U-VR Parada Elite	80
	U-VR Avignon Elite	81
	U-VR Aleesia	82
	U-VR Asencio	83
	U-VR Angelo	84
	U-VR Boticelli	85
	U-VR Pablo	86
	Wall Inset Fires	
	U-VR Elite	87
	U-VR Vichy	88
	U-VR Metz	89
	U-VR Instinct	90
	U-VR Evora Asencio & Asencio	91
	U-VR Vader Aleesia & Aleesia	92-93
	U-VR Celena	94
	U-VR Impulse	95
	Hearth Inset Fires	
	U-VR Arcadia	96
	U-VR Decadence	97
	U-VR Camber	98
	U-VR Frontier	99
	U-VR Essence	100
	U-VR Designer	101
	U-VR Endura	102
	U-VR Contemporary	103

Wall Mounted Fires	
E-XD Prestige	104-105
E-XD Black Glass	106
E-XD Royal Botticino	107
E-XD Travertine	108
E-XD Piano Black	109
Hearth Inset Fires	
E-XD Camber	110
E-XD Decadence	111
E-XD Essence	112
E-XD Arcadia	113
E-XD Signature	114
E-XD Bauhaus	115
E-XD Daisy	116
E-XD Caress	117
Stoves	
Electr stove XD Metal 1 & 2	118-119
Electr stove XD Glass 1 & 2	120-121

Wall Mounted Fires	
Flamonik Rapture	122
Flamonik Enchant	123
Hearth Inset Fires	
Accent Traditional	124
Accent Infusion	125

DIMENSIONS	126-135
-------------------	---------



ELECTRIFLAME VR

Next generation Flame Projection technology creates the flame illusion to the front, the centre, and the rear of the fuel bed. This simulates a totally natural log fire effect that raise the appearance and functionality of electric fires to a new level.

CONFIGURATION

This range of **built-in 3-sided glass models** offer the perfect solution for your feature wall. Available in three sizes **1000, 1250, and 1600**.

E-VR Commodus Smart fires are supplied with side blanking panels giving you the option to customise your installation by converting from a 3-sided fire, to a 2-sided left or right configuration, or to simply install as a single glass fronted wall inset fire.



COLOUR

Enjoy **16 pre-set ambient colour modes**, and over **100+ multi colour combinations** to customise the light ambience on flames, logs, and ember beds. To simplify your choice why not relax with a slow cycle through the colour spectrum in our **fully immersive Animation mode**.



CONNECTIVITY

Get connected with our feature-rich and simple to operate **smart app**. Available to download on the App Store, or get in on Google Play!



CONTROL

Control your fire from your smart phone or tablet with **full handset functionality**. Further applied smart technology allows you to **voice control** your fire using Amazon Alexa and Google Assistant.



Scan the QR code to download our app



Virtual Reality – Smart Flame Projection



Controllable LED lights positioned above, beneath, and behind the fuelbed creates an illusion of hot embers, burning logs, and tall ascending flames that deliver a real fire experience. These lights operate with 16 preset colour selections, advanced automatic hue cycle, or custom interactive personal choice from 100+ colour preference on flames, logs, and ember bed.



E-VR Commodus s1250. 2-sided glass, right side installation.



E-VR Commodus s1600. 3-sided glass installation.





E-VR Quantum s1250 Woodland Logs

EVR QUANTUM s1250/s1000

Electriflame VR Freestanding Smart Illumia Suites

Features

- Flame Projection Technology
- 3 sided glass smart fire
- Dimmable LED surround lighting
- Customisable fuel effect
- Woodland & Silver birch log effect
- Crystal ash embers
- 16 pre-set colours/100+ custom/Animation mode
- LED brightness control
- Thermostatic remote & manual control operation
- Amazon Alexa and Google Assistant compatible



CELSI SMART APP
 Feature-rich and simple to operate. Control your fire from your smart phone or tablet with full handset functionality.



E-VR Quantum s1000 Silver Birch Logs



Video

Specification

Suite Dimensions: mm	s1250: H 785 x W 1565 x D360 s1000: H 785 x W 1390 x D360
Heat Output	0.8kW - 1.6kW
Suite Finish Painted Premium Board	<input type="checkbox"/> Smooth White
Model Number	Quantum s1250 EVR12RE-SWT Quantum s1000 EVR10RE-SWT



Celsi Smart Fires have 16 pre-set ambient colour modes, and over 100+ multi colour combinations to customise the light ambience on flames, logs, and ember beds. To simplify your choice you can relax with a slow cycle through the colour spectrum in our fully immersive Animation mode.



Video

ER CASINO s1250/s1000

Electrifiame VR Freestanding Smart Suites

Features

- Flame Projection Technology
- 3 sided glass smart fire
- Customisable fuel effect
- Woodland & Silver birch log effect
- Crystal ash embers
- 16 pre-set colours/100+ custom/Animation mode
- LED brightness control
- Thermostatic remote & manual control operation
- Amazon Alexa and Google Assistant compatible



CELSI SMART APP
Feature-rich and simple to operate. Control your fire from your smart phone or tablet with full handset functionality.



Celsi Smart Fires have 16 pre-set ambient colour modes, and over 100+ multi colour combinations to customise the light ambience on flames, logs, and ember beds. To simplify your choice you can relax with a slow cycle through the colour spectrum in our fully immersive Animation mode.



E-VR Casino s1000 Silver Birch Logs

E-VR Casino s1250 Woodland Logs



Video

Specification

Suite Dimensions: mm	s1250: H 680 x W 1460 x D274 s1000: H 680 x W 1210 x D274
Heat Output	0.8kW - 1.6kW
Finish Painted Premium Board	<input type="checkbox"/> Smooth White
Model Number	Casino s1250 EVR12CRE-SWT Casino s1000 EVR10CRE-SWT



Video

ER MEDIA 1100

Electrifiame VR Freestanding Illumia Suite



Video



Features

- Flame Projection Technology
- 3 sided glass fire
- Dimmable LED surround lighting
- Media storage
- Customisable fuel effect
- Silver birch effect logs
- Crystal ash embers
- Single or dual colour flame
- LED brightness control
- Thermostatic remote & manual control operation

Flame Projection Technology



Specification

Suite Dimensions: mm	H 1126 x W 1595 x D 408
Heat Output	1.0kW - 2.0kW
Suite Finish Painted Premium Board	<input type="checkbox"/> Smooth White
Model Number	CEVR11VMRE

ER MEDIA 750

Electrifiame VR Freestanding Illumia Suite



Video



Features

- Flame Projection Technology
- 3 sided glass fire
- Dimmable LED surround lighting
- Media storage
- Customisable fuel effect
- Silver birch effect logs
- Crystal ash embers
- Single or dual colour flame
- LED brightness control
- Thermostatic remote & manual control operation

Optional Extras

Woodland logs fuel effect



Specification

Suite Dimensions: mm	H 1126 x W 1400 x D 408
Heat Output	1.0kW - 2.0kW
Finish Painted Premium Board	<input type="checkbox"/> Smooth White
Model Number	CEVR75VMRE

ER CARINO 1100

Electrifiame VR Freestanding Illumia Suite



Video



Features

- Flame Projection Technology
- 3 sided glass fire
- Dimmable LED surround lighting
- Customisable fuel effect
- Silver birch effect logs
- Crystal ash embers
- Single or dual colour flame
- LED brightness control
- Thermostatic remote & manual control operation

Flame Projection Technology



Specification

Suite Dimensions: mm	H 840 x W 1467 x D 370
Heat Output	1.0kW - 2.0kW
Suite Finish Painted Premium Board	<input type="checkbox"/> Smooth White
Model Number	CEVR11CRE

ER CARINO 750

Electrifiame VR Freestanding Illumia Suite



Video



Features

- Flame Projection Technology
- 3 sided glass fire
- Dimmable LED surround lighting
- Customisable fuel effect
- Silver birch effect logs
- Crystal ash embers
- Single or dual colour flame
- LED brightness control
- Thermostatic remote & manual control operation

Optional Extras

Woodland logs fuel effect



Specification

Suite Dimensions: mm	H 840 x W 1118 x D 370
Heat Output	1.0kW - 2.0kW
Finish Painted Premium Board	<input type="checkbox"/> Smooth White
Model Number	CEVR75CRE

ER GEMMA 1000

Electrifiame VR Freestanding Illumia Suite

Features

- Flame Projection Technology
- Glass fronted fire
- Dimmable LED surround lighting
- Customisable fuel effect
- Silver birch effect logs
- Crystal ash embers
- Single or dual colour flame
- LED brightness control
- Thermostatic remote & manual control operation



Smooth White



Textured Black & White



Textured White

Specification

Suite Dimensions: mm	H 724 x W 1565 x D 360	
Heat Output	0.8kW - 1.6kW	
Finish Painted Premium Board	<input type="checkbox"/> Smooth White	EFVR40RE-SWT
Model Number	<input type="checkbox"/> Textured White	EFVR40RE-TWH
	<input type="checkbox"/> Textured Black	EFVR40RE-TBW



Ecodesign Compliant



Video

ER ORBITAL 1000

Electrifiame VR Freestanding Illumia Suite

Features

- Flame Projection Technology
- Glass fronted fire
- Dimmable LED surround lighting
- Customisable fuel effect
- Silver birch effect logs
- Crystal ash embers
- Single or dual colour flame
- LED brightness control
- Thermostatic remote & manual control operation



Smooth Mist



Smooth White

Specification

Suite Dimensions: mm	H 855 x W 1600 x D 360	
Heat Output	0.8kW - 1.6kW	
Finish Painted Premium Board	<input type="checkbox"/>	Smooth White EFVRSWRE
Model Number	<input type="checkbox"/>	Smooth Mist EFVRSMRE



Video



3-sided glass Installation Woodland Logs



Video

Specification

Fire Dimensions: mm	H 330 x W 1600 x D 219
Heat Output	0.8kW - 1.6kW
Model Number	EFVR16RE

ER **COMMODUS s1600**

Electriflame VR Built-In 3 Sided Glass Smart Fire

Features

- Flame Projection Technology
- 3 sided glass smart fire
- Customisable fuel effect
- Woodland & Silver birch effect logs
- Crystal ash embers
- 16 pre-set colours/100+ custom/Animation mode
- LED brightness control
- Thermostatic remote & manual control operation
- Amazon Alexa and Google Assistant compatible
- Side blanking for 2 & 1 sided installations



CELSI SMART APP
Feature-rich and simple to operate. Control your fire from your smart phone or tablet with full handset functionality.



Celsi Smart Fires have 16 pre-set ambient colour modes, and over 100+ multi colour combinations to customise the light ambience on flames, logs, and ember beds. To simplify your choice you can relax with a slow cycle through the colour spectrum in our fully immersive Animation mode.





2-sided glass Installation

COMMODUS s1250

Electriflame VR Built-In 3 Sided Glass Smart Fire

Features

- Flame Projection Technology
- 3 sided glass smart fire
- Customisable fuel effect
- Woodland & Silver birch effect logs
- Crystal ash embers
- 16 pre-set colours/100+ custom/Animation mode
- LED brightness control
- Thermostatic remote & manual control operation
- Amazon Alexa and Google Assistant compatible
- Side blanking for 2 & 1 sided installations



CELSI SMART APP
 Feature-rich and simple to operate. Control your fire from your smart phone or tablet with full handset functionality.



Celsi Smart Fires have 16 pre-set ambient colour modes, and over 100+ multi colour combinations to customise the light ambience on flames, logs, and ember beds. To simplify your choice you can relax with a slow cycle through the colour spectrum in our fully immersive Animation mode.



Video

Specification

Fire Dimensions: mm	H 330 x W 1250 x D 219
Heat Output	0.8kW – 1.6kW
Model Number	EFVR12RE

ER COMMODUS s1000

Electrifiame VR Built-In 3 Sided Glass Smart Fire

Features

- Flame Projection Technology
- 3 sided glass smart fire
- Customisable fuel effect
- Woodland & Silver birch effect logs
- Crystal ash embers
- 16 pre-set colours/100+ custom/Animation mode
- LED brightness control
- Thermostatic remote & manual control operation
- Amazon Alexa and Google Assistant compatible
- Side blanking for 2 & 1 sided installations
- Fascia option available



CELSI SMART APP
Feature-rich and simple to operate. Control your fire from your smart phone or tablet with full handset functionality.



Celsi Smart Fires have 16 pre-set ambient colour modes, and over 100+ multi colour combinations to customise the light ambience on flames, logs, and ember beds. To simplify your choice you can relax with a slow cycle through the colour spectrum in our fully immersive Animation mode.



3-sided glass Installation Silver Birch Logs

Wall Inset with Fascia Woodland Logs



Video

Specification

Fire Dimensions: mm	H 330 x W 1000 x D 219
Fascia Dimensions: mm	H 540 x W 1200 x D 19
Heat Output	0.8kW – 1.6kW
Dual Finish Steel Fabricated Fascia Metallic	Black Nickel & Black Metallic
Model Number	Fire & Fascia EFVR10RE070 Fire only EFVR10RE



Video



ER 1400

Electriflame VR Built-In 3 Sided Glass Fire

Features

- Flame Projection Technology
- 3 sided glass fire
- Customisable fuel effect
- Silver birch effect logs
- Crystal ash embers
- Single or dual colour flame
- LED brightness control
- Thermostatic remote & manual control operation
- Side blanking for 2 & 1 sided installations



Flame Projection Technology



Video

Specification

Fire Dimensions: mm	H 375 x W 1430 x D 275
Heat Output	1.0kW - 2.0kW
Model Number	CEVR14RE

Electrifiame VR Built-In 3 Sided Glass Fire

Features

- Flame Projection Technology
- 3 sided glass fire
- Customisable fuel effect
- Silver birch effect logs
- Crystal ash embers
- Single or dual colour flame
- LED brightness control
- Thermostatic remote & manual control operation
- Side blanking for 2 & 1 sided installations



Flame Projection Technology



Specification

Fire Dimensions: mm	H 374 x W 1130 x D 275
Heat Output	1.0kW – 2.0kW
Model Number	CEVR11RE



Video

ER 750

Electrifiame VR Built-In 3 Sided Glass Fire



Video



Features

- Flame Projection Technology
- 3 sided glass fire
- Customisable fuel effect
- Silver birch effect logs
- Crystal ash embers
- Single or dual colour flame
- LED brightness control
- Thermostatic remote & manual control operation
- Side blanking for 2 & 1 sided installations

Optional Extras

Woodland logs fuel effect



Specification

Fire Dimensions: mm	H 374 x W 780 x D 275
Heat Output	0.8kW – 1.6kW
Model Number	CEVR75RE

ER VOLARE 750

Electrifiame VR 3 Sided Glass Fire Wall Mounted Illumia Suite



Video



Features

- Flame Projection Technology
- 3 sided glass fire
- Dimmable LED surround lighting
- Customisable fuel effect
- Silver birch effect logs
- Crystal ash embers
- Single or dual colour flame
- LED brightness control
- Thermostatic remote & manual control operation
- Includes wall fixing bracket

Optional Extras

Woodland logs fuel effect



Specification

Suite Dimensions: mm	H 721 x W 1400 x D 406
Heat Output	1.0kW – 2.0kW
Finish Painted Premium Board	Smooth White
Model Number	CEVR75VRE

ER VOLARE 1100

Electriflame VR Wall Mounted Illumia Suite

Features

- Flame Projection Technology
- 3 sided glass fire
- Dimmable LED surround lighting
- Customisable fuel effect
- Silver birch effect logs
- Crystal ash embers
- Single or dual colour flame
- LED brightness control
- Thermostatic remote & manual control operation
- Includes wall fixing bracket



Flame Projection Technology



Specification

Suite Dimensions: mm	H 721 x W 1595 x D 406
Heat Output	1.0kW - 2.0kW
Finish Painted Premium Board	<input type="checkbox"/> Smooth White
Model Number	CEVR11VRE



Video

ER COMMODUS

Electriflame VR Wall Inset Fire

Features

- Flame Projection Technology
- Glass fronted fire
- Customisable fuel effect
- Silver birch effect logs
- Crystal ash embers
- Single or dual colour flame
- LED brightness control
- Thermostatic remote & manual control operation
- Fascia option available



Commodus fascia-less installation



Wall Inset with Fascia option

Specification

Fire Dimensions: mm	H 330 x W 981 x D 169
Fascia Dimensions: mm	H 540 x W 1200 x D 19
Heat Output	0.8kW – 1.6kW
Dual Finish Steel Fabricated Fascia Metallic	Black Nickel & Black Metallic
Model Number	Fire Only EFVR40RE Fire + Fascia EFVR40RE070



Video

ER LOUVRE

Electrifiame VR Wall Mounted Fire



Video



Features

- Flame Projection Technology
- Glass fronted fire
- Customisable fuel effect
- Woodland ceramic logs
- Crystal ash embers
- Single or dual colour flame
- LED brightness control
- Thermostatic remote & manual control operation
- Includes wall fixing bracket



Specification

Dimensions: mm	H 519 x W 1102 x D 201
Heat Output	0.8kW - 1.6kW

Dual Finish

Steel Fabricated Brushed Metallic & Glass	Satin Silver & Black Glass
Model Number	CPPSSLRE

ER BASILICA

Electrifiame VR Wall Mounted Fire



Video



Features

- Flame Projection Technology
- Glass fronted fire
- Customisable fuel effect
- Silver birch effect logs
- Crystal ash embers
- Single or dual colour flame
- LED brightness control
- Thermostatic remote & manual control operation
- Includes wall fixing bracket
- Wall inset option



Specification

Dimensions: mm	H 570 x W 1400 x D 90
Heat Output	0.8kW - 1.6kW



Satin Silver & Black

Dual Finish

Steel Fabricated Brushed Metallic Black Painted	Satin Silver & Black EFVR40RE024
Model Number	Satin Champagne & Black



Chrome & Black Nickel

ACERO

Electriflame VR Hearth Inset Fire

Features

- Aspirational 26 inch fascia
- Flame Projection Technology
- Extra wide glass fronted fire
- Customisable fuel effect
- Silver birch effect logs
- Crystal ash embers
- Single or dual colour flame
- LED brightness control
- Thermostatic remote & manual control operation



THERMO-
STATIC



7 DAY
TIMER



ENERGY
SAVING



ISO
FLAME



FLAME
FUSION



Chrome & Satin Silver

Flame Projection Technology



Video

Specification

Dimensions: mm	H 655 x W 657 x D 67
Heat Output	0.8kW - 1.6kW
Dual Finish Steel Fabricated Fascia Metallic	<input type="checkbox"/> Chrome & Satin Silver EVRIASRE <input type="checkbox"/> Chrome & Black Nickel EVRIABRE
Model Number	

Features

- Flame Projection Technology
- Extra wide glass fronted fire
- Customisable fuel effect
- Silver birch effect logs
- Crystal ash embers
- Single or dual colour flame
- LED brightness control
- Thermostatic remote & manual control operation



Satin Silver

Flame Projection Technology



Satin Champagne

Specification

Dimensions: mm	H 602 x W 544 x D 90
Heat Output	0.75kW - 1.5kW

Finish

Steel Fabricated Fascia	<input type="checkbox"/> Satin Silver EVRIPCRC
Brushed Metallic	<input type="checkbox"/> Satin Champagne EVRIPCRC
Model Number	



Video



H3D HOLOGRAM GENESIS

Electriflame H3D Smart Stove

Features

- Holographic Im-Mesh 3D Technology[®]
- Multi Flame Projection Technology[®]
- Living Ember Bed Technology[®]
- Tough steel construction
- Curved design
- Woodland ceramic logs
- 16 pre-set colours/100+ custom/Animation mode
- LED brightness control
- Thermostatic remote & manual control operation
- Amazon Alexa and Google Assistant compatible
- Decorative flue pipe available



CELSI SMART APP
 Feature-rich and simple to operate. Control your fire from your smart phone or tablet with full handset functionality.



The Holographic Im-Mesh 3D technology offers an extensive number of colour options and combinations. Explore dancing flame witchery and smouldering logs with Living Ember Bed Technology, a desirable effect at the forefront of the electric stoves market.

This exciting new generation of electric fires features patented technologies. It is economical to run with high quality LEDs. The heater is thermostatically controlled with settings options. The fire is simple to use and can be operated manually, by remote control, or via WiFi using our dedicated Celsi app. The flame picture can be used in isolation to the heat, and is a popular choice when no heat is required during the summer months, offering exceptionally low running costs.

Instant heat can be applied to a room at anytime with full thermostatic control.



Video

Specification

Dimensions: mm	H 800 x W 500 x D 400
Heat Output	1.0kW - 2.0kW
Finish Steel Fabricated Painted	Black
Model Number	ESEHGORE



ER SPECTRE

Electrifiame VR 3 Sided Glass Smart Stoves



Video

Features

- Flame Projection Smart Technology
- 3 sided glass stove
- Customisable fuel effect
- Woodland ceramic logs
- Crystal ash embers
- 16 pre-set colours/100+ custom/Animation mode
- LED brightness control
- Thermostatic remote & manual control operation
- Amazon Alexa and Google Assistant compatible
- Decorative flue pipe available



CELSI SMART APP

Feature-rich and simple to operate. Control your fire from your smart phone or tablet with full handset functionality.



Celsi Smart Fires have 16 pre-set ambient colour modes, and over 100+ multi colour combinations to customise the light ambience on flames, logs, and ember beds. To simplify your choice you can relax with a slow cycle through the colour spectrum in our fully immersive Animation mode.



Specification

Dimensions: mm	H 800 x W 500 x D 400
Heat Output	1.0kW – 2.0kW
Finish Steel Fabricated Painted	Black
Model Number	EFVRCSE

Optional Extras

- Decorative Steel Flue Pipe Assembly B-1033451

ER SPECTRE LS



Video



Specification

Dimensions: mm	H 1095 x W 500 x D 400
Heat Output	1.0kW – 2.0kW
Finish Steel Fabricated Painted	Black
Model Number	EFVRLRE

Optional Extras

- Decorative Steel Flue Pipe Assembly B-1033451





ER STRATFORD

Electriflame VR Smart Stove

Features

- Flame Projection Smart Technology
- Tough steel body stove
- Customisable fuel effect
- Woodland ceramic logs
- Crystal ash embers
- 16 pre-set colours/100+ custom/Animation mode
- LED brightness control
- Thermostatic remote & manual control operation
- Amazon Alexa and Google Assistant compatible
- Decorative flue pipe available



CELSI SMART APP
 Feature-rich and simple to operate. Control your fire from your smart phone or tablet with full handset functionality.



Celsi Smart Fires have 16 pre-set ambient colour modes, and over 100+ multi colour combinations to customise the light ambience on flames, logs, and ember beds. To simplify your choice you can relax with a slow cycle through the colour spectrum in our fully immersive Animation mode.



Video

Specification

Dimensions: mm	H 590 x W 500 x D 330
Heat Output	1.0kW - 2.0kW
Finish Steel Fabricated Painted	 Black
Model Number	EFVRSTRE

Electriflame VR Stove

Features

- Flame Projection Technology
- Tough steel body
- Curved door design
- Customisable fuel effect
- Silver birch effect logs
- Crystal ash embers
- Single or dual colour flame
- LED brightness control
- Thermostatic remote & manual control operation



Optional Extras

- Woodland ceramic logs
- Decorative Steel Flue Pipe Accessories



Specification

Dimensions: mm	H 606 x W 532 x D 372
Heat Output	1.0kW - 2.0kW
Finish Steel Fabricated Painted	Black
Model Number	CEVRSRRE



Video



Video



Features

- Flame Projection Technology
- Tough steel body
- Customisable fuel effect
- Silver birch effect logs
- Crystal ash embers
- Single or dual colour flame
- LED brightness control
- Thermostatic remote & manual control operation



Optional Extras

- Woodland ceramic logs
- Decorative Steel Flue Pipe Accessories



Finish

Steel Fabricated Painted	Black
Model Number	CEVRSARE

Specification

Dimensions: mm	H 582 x W 430 x D 389
Heat Output	0.75kW - 1.5kW



Video



Features

- Flame Projection Technology
- Tough steel body
- Customisable fuel effect
- Silver birch effect logs
- Crystal ash embers
- Single or dual colour flame
- LED brightness control
- Thermostatic remote & manual control operation



Optional Extras

- Woodland ceramic logs
- Decorative Steel Flue Pipe Accessories



Finish

Steel Fabricated Painted	Black
Model Number	CEVRSLRE

Specification

Dimensions: mm	H 595 x W 471 x D 359
Heat Output	0.75kW - 1.5kW

REAL WOOD LOGS

NATURAL FIRE RANGE

CELSI have taken Ultiflame Virtual Reality fires to the next level. Our most successful natural flame effect is now further complemented with a maximum depth exciting arrangement of real wood logs fixed into a lively 'Active crystal ember fuel bed'

The fire realism is sensational, and the natural wood log arrangement is visually stunning.

This next generation electric fire effect is available in a range of contemporary Firebeams and Suites, each including integrated dimmable LED lighting.



REAL WOOD

100% Real Wood Logs, natural, authentic, and unique. Accept no imitations!

Page 14



U-VR Firebeam XL 600 Suite

Page 8



U-VR Firebeam 800 Suite

Page 17



U-VR Luminaire 600 Suite

Page 18



U-VR Skyfall 800 Suite



Our Firebeam models include wall mounted beams smartly framed by sleek glass with chrome fittings that totally complement this product.

For a larger feature wall suite see our 'Firebeam XL' models, these provide a luxury feature fireplace that requires less wall depth for easy installation.

For a completely fuss-free installation our freestanding suites only require the need to place down and plug in.

CELSI Ultiflame VR fires are premium products with integrated design features for optimal energy saving performance and assurance.



Active Blazing Embers



Virtual Reality – True Flame Experience

FIREBEAM 800

Ultriflame VR Inset Illumia Suite

Features

- Open fire experience
- Extra deep fuel bed
- Natural real wood logs
- Active crystal embers
- Single or dual colour flame
- LED brightness control
- Thermostatic remote & manual control operation
- Dimmable LED beam lighting



Smooth White



Real Wood Logs



Smooth Mist

Specification

Suite Dimensions: mm	H 540 x W 1200 x D 170
Heat Output	1.0kW – 2.0kW
Finish Painted Premium Board	<input type="checkbox"/> Smooth White CEULF8RE-SWT
Model Number	<input type="checkbox"/> Smooth Mist CEULF8RE-ELB



Video

FIREBEAM 600

Ultr flame VR Inset Illumia Suite

Features

- Open fire experience
- Extra deep fuel bed
- Natural real wood logs
- Active crystal embers
- Single or dual colour flame
- LED brightness control
- Thermostatic remote & manual control operation
- Dimmable LED beam lighting



Smooth Mist



Real Wood Logs



Smooth White

Specification

Suite Dimensions: mm	H 615 x W 870 x D 170
Heat Output	1.0kW – 2.0kW
Finish Painted Premium Board	<input type="checkbox"/> Smooth White CEULF6RE-SWT
Model Number	<input type="checkbox"/> Smooth Mist CEULF6RE-ELB



Video

WR FIREBEAM XL800

Ultriflame VR Semi-Inset Illumia Suite

Features

- Open fire experience
- Extra deep fuel bed
- Natural real wood logs
- Active crystal embers
- Single or dual colour flame
- LED brightness control
- Thermostatic remote & manual control operation
- Dimmable LED beam lighting



Real Wood Logs



Specification

Suite Dimensions: mm	H 697 x W 1302 x D 213
Heat Output	1.0kW – 2.0kW
Finish Painted Premium Board	<input type="checkbox"/> Smooth White
Model Number	CEUXF8RE-SWT



Video

WR FIREBEAM XL600

Ultriflame VR Semi-Inset Illumia Suite

Features

- Open fire experience
- Extra deep fuel bed
- Natural real wood logs
- Active crystal embers
- Single or dual colour flame
- LED brightness control
- Thermostatic remote & manual control operation
- Dimmable LED beam lighting



Real Wood Logs



Specification

Suite Dimensions: mm	H 794 x W 970 x D 213
Heat Output	1.0kW – 2.0kW
Finish Painted Premium Board	<input type="checkbox"/> Smooth White
Model Number	CEUXF6RE-SWT



Video

LUMINAIRE 800

Ultriflame VR Freestanding Illumia Suite



Video



Features

- Open fire experience
- Extra deep fuel bed
- Natural real wood logs
- Active crystal embers
- Single or dual colour flame
- LED brightness control
- Thermostatic remote & manual control operation
- Dimmable LED suite lighting

Real Wood Logs



Specification

Suite Dimensions: mm	H 1005 x W 1478 x D 400
Heat Output	1.0kW – 2.0kW
Finish Painted Premium Board	<input type="checkbox"/> Smooth White
Model Number	CEULL8RE-SWT

LUMINAIRE 600

Ultriflame VR Freestanding Illumia Suite



Video



Features

- Open fire experience
- Extra deep fuel bed
- Natural real wood logs
- Active crystal embers
- Single or dual colour flame
- LED brightness control
- Thermostatic remote & manual control operation
- Dimmable LED suite lighting

Real Wood Logs



Specification

Suite Dimensions: mm	1108x W 1350 x D 400
Heat Output	1.0kW – 2.0kW
Finish Painted Premium Board	<input type="checkbox"/> Smooth White
Model Number	CEULL6RE-SWT

WR SKYFALL 800

Ultiflame VR Freestanding Illumia Suite

Features

- Open fire experience
- Extra deep fuel bed
- Natural real wood logs
- Active crystal embers
- Single or dual colour flame
- LED brightness control
- Thermostatic remote & manual control operation
- Dimmable LED suite lighting



Smooth White



Real Wood Logs



Smooth White & Mist

Specification

Suite Dimensions: mm	H 775 x W 1480 x D 375
Heat Output	1.0kW - 2.0kW
Finish Painted Premium Board	<input type="checkbox"/> Smooth White CEULS8RE-SWT
Model Number	<input type="checkbox"/> Smooth White & Mist CEULS8RE-ELB



Video

SKYFALL 600

Ultiflame VR Freestanding Illumia Suite

Features

- Open fire experience
- Extra deep fuel bed
- Natural real wood logs
- Active crystal embers
- Single or dual colour flame
- LED brightness control
- Thermostatic remote & manual control operation
- Dimmable LED suite lighting



Smooth White & Mist



Real Wood Logs



Smooth White & Mist

Specification

Suite Dimensions: mm	H 775 x W 1480 x D 375
Heat Output	1.0kW - 2.0kW
Finish Painted Premium Board	<input type="checkbox"/> Smooth White CEULS6RE-SWT
Model Number	<input type="checkbox"/> Smooth White & Mist CEULS6RE-ELB



Video

VR ORBITAL 800

Ultiflame VR Freestanding Illumia Suite



Video



Smooth Mist

Features

- Open fire experience
- Dimmable LED surround lighting
- Customisable fuel effect
- Silver birch effect logs
- Crystal ash embers
- Single or dual colour flame
- LED brightness control
- Thermostatic remote & manual control operation



Smooth Cream



Smooth White

Suite Finish

- Painted Premium Board Smooth White CEULOWRE-ERP
- Black inner panel Smooth Mist CEULOMRE-ERP
- Model Number Smooth Cream CEULOCRE-ERP

Specification

Suite Dimensions: mm	H 850 x W 1466 x D 360
Heat Output	0.8kW - 1.6kW

VR VEGA

Ultiflame VR Freestanding Illumia Suite



Video



Features

- Open fire experience
- Customisable fuel effect
- Silver birch effect logs
- Crystal ash embers
- Single or dual colour flame
- LED brightness control
- Thermostatic remote & manual control operation



Specification

Suite Dimensions: mm	H 892 x W 1430 x D 330
Heat Output	0.8kW - 1.6kW

Suite Finish

- Painted Premium Board Smooth White
- Black inner panel
- Model Number CEULVWRE-ERP

VR GEMMA 800

Ultriflame VR Freestanding Illumia Suite

Features

- Open fire experience
- Dimmable LED surround lighting
- Customisable fuel effect
- Silver birch effect logs
- Crystal ash embers
- Single or dual colour flame
- LED brightness control
- Thermostatic remote & manual control operation



Smooth White



Textured Black & White



Textured White

Specification

Suite Dimensions: mm	H 740 x W 1465 x D 360
Heat Output	0.8kW - 1.6kW
Finish Painted Premium Board	<input type="checkbox"/> Smooth White CEUL9GRE-SWT <input type="checkbox"/> Textured White CEUL9GRE-TWH <input type="checkbox"/> Textured Black CEUL9GRE-TBW
Model Number	



Video

VR GEMMA 600

Ultiflame VR Freestanding Illumia Suite



Video



Features

- Open Fronted Fire
- Dimmable LED surround lighting
- Customisable fuel effect
- Silver birch effect logs
- Crystal ash embers
- Single or dual colour flame
- LED brightness control
- Thermostatic remote & manual control operation



Smooth White



Textured Black & White

Suite Finish

- Painted Premium Board
- Smooth White CEUL6GRE-SWT
 - Textured White CEUL6GRE-TWH
 - Textured Black CEUL6GRE-TBW
- Model Number



Specification

Suite Dimensions: mm	H 835 W 1185 D 360
Heat Output	0.8kW - 1.6kW

VR ADOUR ALEESIA

Ultiflame VR Freestanding Illumia Suite



Video



Features

- Glass Fronted Fire
- Dimmable LED surround lighting
- Customisable fuel effect
- Silver birch effect logs
- Crystal ash embers
- Single or dual colour flame
- LED brightness control
- Thermostatic remote & manual control operation

Flame Fusion – dual colour



Specification

Suite Dimensions: mm	H 990 x W 1465 x D 380
Heat Output	0.8kW - 1.6kW

Suite Finish

- Painted Premium Board
- Smooth White
- Model Number
- CEUALRE-WWS

Smooth White



ADOUR ELITE

Ultriflame VR Freestanding Illumia Suite

Features

- Open fire experience
- Dimmable LED surround lighting
- Customisable fuel effect
- Silver birch effect logs
- Crystal ash embers
- Single or dual colour flame
- LED brightness control
- Thermostatic remote & manual control operation



Smooth Mist



Smooth Cream



Video

Specification

Suite Dimensions: mm	H 990 x W 1465 x D 380
Heat Output	0.8kW - 1.6kW
Finish Painted Premium Board	<input type="checkbox"/> Smooth White CEULA3REWO
Model Number	<input type="checkbox"/> Smooth Mist CEULA3RESO
	<input type="checkbox"/> Smooth Cream CEULA3RECO

ADOUR ASENCIO

Ultiflame VR Freestanding Illumia Suite



Video



Features

- Glass Fronted Fire
- Dimmable LED surround lighting
- Customisable fuel effect
- Silver birch effect logs
- Crystal ash embers
- Single or dual colour flame
- LED brightness control
- Thermostatic remote & manual control operation

Flame Fusion – dual colour



Specification

Suite Dimensions: mm	H 1090 x W 1340 x D 380
Heat Output	0.8kW – 1.6kW

Suite Finish

Painted Premium Board Black back panel and hearth	<input type="checkbox"/> Smooth White
Model Number	CEULASSRE

ADOUR

Ultiflame VR Freestanding Illumia Suite



Video



Features

- Open fire experience
- Dimmable LED surround lighting
- Customisable fuel effect
- Silver birch effect logs
- Crystal ash embers
- Single or dual colour flame
- LED brightness control
- Thermostatic remote & manual control operation



Specification

Suite Dimensions: mm	H 1090 x W 1340 x D 380
Heat Output	0.8kW – 1.6kW

Suite Finish

Painted Premium Board Black back panel and hearth	<input type="checkbox"/> Smooth White
Model Number	CEULA2REWB



Ultiflame VR Freestanding Illumia Suite



Video



Features

- Open fire experience
- Dimmable LED surround lighting
- Customisable fuel effect
- Silver birch effect logs
- Crystal ash embers
- Single or dual colour flame
- LED brightness control
- Thermostatic remote & manual control operation



Specification

Suite Dimensions: mm	H 1090 W 1340 D 340
Heat Output	0.8kW - 1.6kW

Suite Finish

Painted Premium Board Black back panel and hearth	<input type="checkbox"/> Smooth White
Model Number	CEUL6IRE-ERP



Ultiflame VR Freestanding Suite



Video



Features

- Open fire experience
- Customisable fuel effect
- Silver birch effect logs
- Crystal ash embers
- Single or dual colour flame
- LED brightness control
- Thermostatic remote & manual control operation



Specification

Suite Dimensions: mm	H 892 x W 1228 x D 330
Heat Output	0.8kW - 1.6kW



Smooth Cream



Smooth White

Suite Finish

Painted Premium Board Black back panel and hearth	<input type="checkbox"/> Smooth White CEULEWRE-ERP
Model Number	<input type="checkbox"/> Smooth Mist CEULEMRE-ERP
	<input type="checkbox"/> Smooth Cream CEULECRE-ERP

PARADA ELITE

Ultiflame VR Inset Limestone Illumia Suite



Video



Features

- Open fire experience
- Dimmable LED surround lighting
- Customisable fuel effect
- Silver birch effect logs
- Crystal ash embers
- Single or dual colour flame
- LED brightness control
- Thermostatic remote & manual control operation
- Available in two sizes



Specification

Suite Dimensions: mm	54" 58"	H 990 x W 1350 x D 400 H 990 x W 1464 x D 400
Heat Output	0.8kW – 1.6kW	

Suite Finish

Natural	<input type="checkbox"/> Limestone
Model Number	54" CEULPSRE-ERP 58" CEULPRE-ERP

AVIGNON ELITE

Ultiflame VR Inset Limestone Suite



Video



Features

- Open fire experience
- Customisable fuel effect
- Silver birch effect logs
- Crystal ash embers
- Single or dual colour flame
- LED brightness control
- Thermostatic remote & manual control operation
- Available in two sizes



Specification

Suite Dimensions: mm	54" 58"	H 990 x W 1350 x D 380 H 990 x W 1464 x D 380
Heat Output	0.8kW – 1.6kW	

Suite Finish

Natural	<input type="checkbox"/> Limestone
Model Number	54" CEUALRE-ERP 58" CEULASRE-ERP



Video



Features

- Glass Fronted Fire
- Dimmable LED surround lighting
- Customisable fuel effect
- Silver birch effect logs
- Crystal ash embers
- Single or dual colour flame
- LED brightness control
- Thermostatic remote & manual control operation
- Available in two sizes



Specification

Suite Dimensions: mm	54" 58"	H 1050 x W 1370 x D 400 H 1050 x W 1470 x D 400
Heat Output	0.8kW – 1.6kW	

Suite Finish

Natural	<input type="checkbox"/> Limestone
Model Number	54" CEULAS4RE 58" CEULAS8RE



Video



Features

- Glass Fronted Fire
- Customisable fuel effect
- Silver birch effect logs
- Crystal ash embers
- Single or dual colour flame
- LED brightness control
- Thermostatic remote & manual control operation



Specification

Suite Dimensions: mm	H 1095 x W 1376 x D 380
Heat Output	0.8kW – 1.6kW

Suite Finish

Natural	<input type="checkbox"/> Limestone
Model Number	CEULASSRE



Video



Features

- Open fire experience
- Customisable fuel effect
- Silver birch effect logs
- Crystal ash embers
- Single or dual colour flame
- LED brightness control
- Thermostatic remote & manual control operation



Specification

Suite Dimensions: mm	H 1070 x W 1370 x D 380
Heat Output	0.8kW - 1.6kW

Suite Finish

Natural	<input type="checkbox"/> Limestone
Model Number	CEULLIRE-ERP



Video



Features

- Open fire experience
- Customisable fuel effect
- Silver birch effect logs
- Crystal ash embers
- Single or dual colour flame
- LED brightness control
- Thermostatic remote & manual control operation



Specification

Suite Dimensions: mm	H 1060 x W 1370 x D 380
Heat Output	0.8kW - 1.6kW

Suite Finish

Natural	<input type="checkbox"/> Limestone
Model Number	CEULAVRE-ERP



Ultiflame VR Inset Limestone Suite



Video



Features

- Open fire experience
- Customisable fuel effect
- Silver birch effect logs
- Crystal ash embers
- Single or dual colour flame
- LED brightness control
- Thermostatic remote & manual control operation



Specification

Suite Dimensions: mm	H 1060 x W 1220 x D 410
Heat Output	0.8kW - 1.6kW

Suite Finish

Natural	<input type="checkbox"/> Limestone
Model Number	CEULRSRE-ERP



Ultiflame VR Wall Inset Fire



Video



Features

- Open fire experience
- Customisable fuel effect
- Silver birch effect logs
- Crystal ash embers
- Single or dual colour flame
- LED brightness control
- Thermostatic remote & manual control operation



Specification

Fire Dimensions: mm	H 352 x W 843 x D 182
Heat Output	0.8kW - 1.6kW
Model Number	CEUL33RE-ERP



Ultiflame VR Wall Inset Fire



Video

Satin Silver



Features

- Open fire experience
- Customisable fuel effect
- Silver birch effect logs
- Crystal ash embers
- Single or dual colour flame
- LED brightness control
- Thermostatic remote & manual control operation



Black Textured



Satin Champagne

Finish

Steel Fabricated Fascia
Brushed Metallic
or Black Textured Paint

- Satin Champagne CEUL33RE971
- Black Textured CEUL33RE915

Model Number

Specification

Dimensions: mm	H 540 x W 1490 x D 71
Heat Output	0.8kW - 1.6kW



Ultiflame VR Wall Inset Fire



Video

Satin Champagne



Features

- Open fire experience
- Customisable fuel effect
- Silver birch effect logs
- Crystal ash embers
- Single or dual colour flame
- LED brightness control
- Thermostatic remote & manual control operation



Satin Silver

Finish

Steel Fabricated Fascia
Brushed Metallic

- Satin Silver CEUL33RE919
- Satin Champagne CEUL33RE931

Model Number

Specification

Dimensions: mm	H 540 x W 1490 x D 22.5
Heat Output	0.8kW - 1.6kW

INSTINCT

Ultiflame VR Wall Inset Fire



Video



Satin Champagne

Features

- Open fire experience
- Customisable fuel effect
- Silver birch effect logs
- Crystal ash embers
- Single or dual colour flame
- LED brightness control
- Thermostatic remote & manual control operation



Satin Black



Specification

Dimensions: mm	H 647 x W 1138 x D 60
Heat Output	0.8kW - 1.6kW

Finish

Steel Fabricated Fascia	Satin Champagne CECH33RE-ERP
Steel Fabricated Fascia	Satin Black CEBC33RE-ERP
Brushed Metallic	
Model Number	

EVORA ASENCIO & ASENCIO

Ultiflame VR Wall Inset Fire



Video



Evora Asencio

Features

- Glass fronted fire
- Customisable fuel effect
- Silver birch effect logs
- Crystal ash embers
- Single or dual colour flame
- LED brightness control
- Thermostatic remote & manual control operation



Asencio trimless installation



Specification

Dimensions: mm	Evora Asencio H 768 x W 762 x D 19
	Asencio H 570x W 570 x D 183
Heat Output	0.8kW - 1.6kW

Dual Finish

Steel Fabricated Fascia Metallic	Black Nickel & Chrome Evora Asencio CEULASRE-FAS
Model Number	Asencio CEULASRE

Vader Aleesia Black Nickel & Black



VADER ALEESIA & ALEESIA

Ultiflame VR Wall Inset Fire

Features

- Glass fronted fire
- Customisable fuel effect
- Silver birch effect logs
- Crystal ash embers
- Single or dual colour flame
- LED brightness control
- Thermostatic remote & manual control operation



Vader Aleesia Black Nickel & Chrome



Aleesia trimless installation



Video

Specification

Dimensions: mm	Vader Aleesia H 683 x W 963 x D 21 Aleesia H 490 x W 770 x D 183
Heat Output	0.8kW - 1.6kW
Steel Fabricated Fascia Dual Metallic Finish	 Black Nickel & Black CEULALRE-BNB
Model Number	 Black Nickel & Chrome CEULALRE-BNC  Aleesia CEULALRE



Video



Features

- Open fire experience
- Customisable fuel effect
- Silver birch effect logs
- Crystal ash embers
- Single or dual colour flame
- LED brightness control
- Thermostatic remote & manual control operation



Specification

Fire Dimensions: mm	H 447 x W 560 x D 182
Heat Output	0.8kW - 1.6kW
Model Number	CEUL22RE-ERP



Video



Satin Silver

Features

- Open fire experience
- Customisable fuel effect
- Silver birch effect logs
- Crystal ash embers
- Single or dual colour flame
- LED brightness control
- Thermostatic remote & manual control operation



Specification

Dimensions: mm	H 742 x W 860 x D 60
Heat Output	0.8kW - 1.6kW



Satin Black

Finish

Steel Fabricated Fascia Brushed Metallic	Satin Silver CESS22RE-ERP
Model Number	Satin Black CEBC22RE-ERP



Video



Black & Gold

Features

- Open fire experience
- Customisable fuel effect
- Silver birch effect logs
- Crystal ash embers
- Single or dual colour flame
- LED brightness control
- Thermostatic remote & manual control operation



Optional Extras

75mm Spacer frame
For flat wall installation



Black & Chrome

Finish

- Anodised Aluminium
- Fascia Brushed Metallic or Black Textured Paint
- Model Number

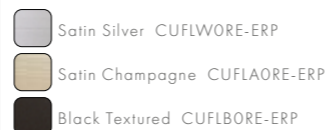

Specification	
Dimensions: mm	H 612 x W 528 x D 154
Heat Output	0.75kW – 1.5kW



Video



Chrome

Features

- Open fire experience
- Customisable fuel effect
- Silver birch effect logs
- Crystal ash embers
- Single or dual colour flame
- LED brightness control
- Thermostatic remote & manual control operation



Optional Extras

75mm Spacer frame
For flat wall installation



Gold



Black Nickel

Specification

Dimensions: mm	H 630 x W 528.5 x D 151
Heat Output	0.75kW – 1.5kW

Dual Finish

- Steel Fabricated Fascia Paint & Metallic
- Model Number



CUFLSRE-ERP



Video



Satin Silver

Features

- Open fire experience
- Customisable fuel effect
- Silver birch effect logs
- Crystal ash embers
- Single or dual colour flame
- LED brightness control
- Thermostatic remote & manual control operation



Optional Extras

75mm Spacer frame
For flat wall installation



Satin Champagne

Black Textured

Finish

- Anodised Aluminium
- Fascia Brushed Metallic or Black Textured Paint
- Model Number
-  Satin Silver CUFLWORE-ERP
 -  Satin Champagne CUFLAORE-ERP
 -  Black Textured CUFLBORE-ERP

Specification

Dimensions: mm	H 619 x W 537 x D 135
Heat Output	0.75kW - 1.5kW



Video



Features

- Open fire experience
- Customisable fuel effect
- Silver birch effect logs
- Crystal ash embers
- Single or dual colour flame
- LED brightness control
- Thermostatic remote & manual control operation



Optional Extras

75mm Spacer frame
For flat wall installation

Specification

Dimensions: mm	H 617 x W 541 x D 131
Heat Output	0.75kW - 1.5kW

Dual Finish

Steel Fabricated Fascia Paint & Metallic	 Black Textured & Chrome
Model Number	CUFLFSRE-ERP



Video



Black

Features

- Open fire experience
- Customisable fuel effect
- Silver birch effect logs
- Crystal ash embers
- Single or dual colour flame
- LED brightness control
- Thermostatic remote & manual control operation



Optional Extras

75mm Spacer frame
For flat wall installation



Satin Silver

Specification

Dimensions: mm	H 619 x W 537 x D 127
Heat Output	0.75kW - 1.5kW

Finish

- Steel Fabricated Fascia
 - Brushed Metallic
 - Smooth Black Paint
 - Model Number
- Satin Silver CUFLDRE-ERP
 - Smooth Black CUFLD2RE-ERP



Video



Black Nickel & Chrome

Features

- Open fire experience
- Customisable fuel effect
- Silver birch effect logs
- Crystal ash embers
- Single or dual colour flame
- LED brightness control
- Thermostatic remote & manual control operation



Optional Extras

75mm Spacer frame
For flat wall installation



Chrome & Black

Specification

Dimensions: mm	H 599 x W 498 x D 129
Heat Output	0.75kW - 1.5kW

Dual Finish

- Steel Fabricated Fascia
 - Metallic
 - Model Number
- Black Nickel & Chrome CUFLDSRE-ERP
 - Chrome & Black CUFLCBRE-ERP



Video



Chrome

Features

- Open fire experience
- Customisable fuel effect
- Silver birch effect logs
- Crystal ash embers
- Single or dual colour flame
- LED brightness control
- Thermostatic remote & manual control operation



Optional Extras

75mm Spacer frame
For flat wall installation



Black

Finish

Steel Fabricated Fascia
Metallic or Smooth Black Paint
Model Number

- Chrome CUFLESRE-ERP
- Black CUFLEBRE-ERP

Specification	
Dimensions: mm	H 598 x W 497 x D 126
Heat Output	0.75kW - 1.5kW



Video



Satin Silver

Features

- Open fire experience
- Customisable fuel effect
- Silver birch effect logs
- Crystal ash embers
- Single or dual colour flame
- LED brightness control
- Thermostatic remote & manual control operation



Optional Extras

75mm Spacer frame
For flat wall installation



Satin Champagne

Finish

Steel Fabricated Fascia
Brushed Metallic
Model Number

- Satin Silver CUFCSRE-ERP
- Satin Champagne CUFLCCRE-ERP

Specification	
Dimensions: mm	H 598 x W 493 x D 132
Heat Output	0.75kW - 1.5kW

EXD PRESTIGE

Electriflame XD Wall Mounted Fire

Features

- Glass fronted fire
- High definition effect
- Extra deep 3D coals
- Relaxing smoky flames
- LED brightness control
- Thermostatic remote & manual control operation
- Includes wall fixing bracket



Atmospheric flame ascension



Specification

Dimensions: mm	H 600 x W 1100 x D 150
Heat Output	0.75kW - 1.5kW
Finish Natural Marble	 Prestige Brown
Model Number	EFH11TBRE



Video

EXO BLACK GLASS



Video

Electriflame XD Wall Mounted Fire

Black Glass 1300



Features

- Glass fronted fire
- High definition effect
- Extra deep 3D coals
- Relaxing smoky flames
- LED brightness control
- Thermostatic remote & manual control operation
- Includes wall fixing bracket
- Available in two sizes



Black Glass 1100



Specification

Dimensions: mm	H 600 x W 1300 & 1100 x D 126
Heat Output	0.75kW - 1.5kW

Finish

Glass	Black Glass
Model Number	1300 EFH13BGRE 1100 EFH11BGRE

EXO ROYAL BOTTICINO



Video

Electriflame XD Wall Mounted Fire



Features

- Glass fronted fire
- High definition effect
- Extra deep 3D coals
- Relaxing smoky flames
- LED brightness control
- Thermostatic remote & manual control operation
- Includes wall fixing bracket



Specification

Dimensions: mm	H 600 x W 1100 x D 150
Heat Output	0.75kW - 1.5kW

Finish

Natural Marble	Royal Botticino
Model Number	EFH11RBRE

EXO TRAVERTINE

Electriflame XD Wall Mounted Fire



Video

Travertine 1100



Features

- Glass fronted fire
- High definition effect
- Extra deep 3D coals
- Relaxing smoky flames
- LED brightness control
- Thermostatic remote & manual control operation
- Includes wall fixing bracket
- Available in two sizes



Travertine 1300



Specification

Dimensions: mm	H 625 x W 1300 & 1100 x D 150
Heat Output	0.75kW - 1.5kW

Finish

Natural	Travertine
Model Number	EFH11TVRE

EXO PIANO BLACK

Electriflame XD Wall Mounted Fire



Video



Features

- Glass fronted fire
- High definition effect
- Extra deep 3D coals
- Relaxing smoky flames
- LED brightness control
- Thermostatic remote & manual control operation
- Includes wall fixing bracket



Specification

Dimensions: mm	H 600 x W 1300 x D 150
Heat Output	0.75kW - 1.5kW

Finish

Glossy Painted	Black
Model Number	EFH13PBRE

EXO CAMBER

Electriflame XD Hearth Inset Fire



Video



Satin Champagne

Features

- Glass fronted fire
- Customisable fuel effect
- Silver birch effect logs
- Crystal ash embers
- Single or dual colour flame
- LED brightness control
- Thermostatic remote & manual control operation



Optional Extras



75mm Spacer frame
For flat wall installation



Satin Silver

Black Textured

Finish

- Anodised Aluminium
Fascia Brushed Metallic
Textured Black Point
- Model Number
-  Satin Silver EHXDWORE-ERP
 -  Satin Champagne EHXDAORE-ERP
 -  Black Textured EHXDBORE-ERP

Specification

Dimensions: mm	H 619 x W 537 x D 105
Heat Output	0.75kW - 1.5kW

EXO DECADENCE

Electriflame XD Hearth Inset Fire



Video



Gold

Features

- Glass fronted fire
- Customisable fuel effect
- Silver birch effect logs
- Crystal ash embers
- Single or dual colour flame
- LED brightness control
- Thermostatic remote & manual control operation



Optional Extras

75mm Spacer frame
For flat wall installation



Chrome

Black Nickel

Specification

Dimensions: mm	H 630 x W 528.5 x D 122
Heat Output	0.75kW - 1.5kW

Finish

- High Quality Cast Iron
Fascia Metallic Plated
- Model Number
-  Chrome EHXDDCRE-ERP
 -  Gold EHXDDGRE-ERP
 -  Black Nickel EHXDBDRE-ERP



Video



Satin Silver

Features

- Glass fronted fire
- Customisable fuel effect
- Silver birch effect logs
- Crystal ash embers
- Single or dual colour flame
- LED brightness control
- Thermostatic remote & manual control operation



Optional Extras

75mm Spacer frame
For flat wall installation



Black

Specification

Dimensions: mm	H 610 x W 537 x D 105
Heat Output	0.75kW - 1.5kW

Finish

Steel Fabricated Fascia
Brushed Metallic
or Smooth Black Paint
Model Number

- Satin Silver EHXDDORE-ERP
- Smooth Black EHXDD2RE-ERP



Video



Black & Chrome

Features

- Glass fronted fire
- Customisable fuel effect
- Silver birch effect logs
- Crystal ash embers
- Single or dual colour flame
- LED brightness control
- Thermostatic remote & manual control operation



Optional Extras

75mm Spacer frame
For flat wall installation



Black & Gold

Specification

Dimensions: mm	H 612 x W 528 x D 130
Heat Output	0.75kW - 1.5kW

Dual Finish

High Quality Cast Iron
Fascia Dual Metallic Plated
Model Number

- Black & Gold EHXDDGRE-ERP
- Black & Chrome EHXDDCRE-ERP



Video



Black Nickel & Black

Features

- Glass fronted fire
- Customisable fuel effect
- Silver birch effect logs
- Crystal ash embers
- Single or dual colour flame
- LED brightness control
- Thermostatic remote & manual control operation



Optional Extras

75mm Spacer frame
For flat wall installation



Satin Silver & Chrome

Dual Finish

- Steel Fabricated
 - Fascia Metallic
 - Model Number
- Black Nickel & Black EHXDSNRE-ERP
 - Satin Silver & Chrome EHXDSCRE-ERP

Specification

Dimensions: mm	H 599 x W 498 x D 129
Heat Output	0.75kW - 1.5kW



Video



Black

Features

- Glass fronted fire
- Customisable fuel effect
- Silver birch effect logs
- Crystal ash embers
- Single or dual colour flame
- LED brightness control
- Thermostatic remote & manual control operation



Optional Extras

75mm Spacer frame
For flat wall installation



Brass



Chrome

Finish

- Quality Cast Trim and Fret
 - Solid Brass or Cast Iron
 - Black paint detail
 - Model Number
- Brass EHXDBBRE-ERP
 - Chrome EHXDBSRE-ERP
 - Black EHXDBSRE-ERP

Specification

Dimensions: mm	H 595 x W 490 x D 100
Heat Output	0.75kW - 1.5kW



Electriflame XD Hearth Inset Fire



Video



Features

- Glass fronted fire
- Customisable fuel effect
- Silver birch effect logs
- Crystal ash embers
- Single or dual colour flame
- LED brightness control
- Thermostatic remote & manual control operation



Optional Extras

75mm Spacer frame
For flat wall installation



Brass

Black

Finish

- Steel Fabricated Trim
 - Solid Brass or Cast Iron Fret
 - Metallic or Smooth Black Paint
 - Model Number
- Brass EHXDDBRE-ERP
 - Satin Silver EHXDDRE-ERP
 - Black EHXDDNRE-ERP

Specification

Dimensions: mm	H 595 x W 490 x D 100
Heat Output	0.75kW - 1.5kW



Electriflame XD Hearth Inset Fire



Video



Features

- Glass fronted fire
- Customisable fuel effect
- Silver birch effect logs
- Crystal ash embers
- Single or dual colour flame
- LED brightness control
- Thermostatic remote & manual control operation



Optional Extras

75mm Spacer frame
For flat wall installation



Brass

Finish

- Quality Cast Trim and Fret
 - Solid Brass or Cast Iron
 - Black paint detail
 - Model Number
- Brass & Black EHXDCBRE-ERP
 - Satin Silver EHXDCSRE-ERP

Specification

Dimensions: mm	H 650 x W 535 x D 100
Heat Output	0.75kW - 1.5kW

Metal 2



EXO METAL 1 & 2

Electr stove XD Stove

Features

- Tough steel body & door
- High definition effect
- Extra deep 3D coals
- Relaxing smoky flames
- LED brightness control
- Thermostatic remote & manual control operation



THERMO-STATIC



8 HOUR TIMER



ENERGY SAVING



ISO FLAME



Metal 1



METAL 1
Video



METAL 2
Video

Specification

Dimensions: mm	Metal 1 Metal 2	H 579 x W 430 x D 332 H 587 x W 524 x D 295
Heat Output		1.0kW - 2.0kW
Finish Steel Fabricated Body		Black
Model Number	Metal 1 Metal 2	CESSMDRE-ERP CESLMDRE-ERP

Optional Extras

- Woodland logs fuel effect
- Decorative Steel Flue Pipe Accessories

EXO GLASS 1 & 2

Electr stove XD Stove

Features

- Tough steel body
- Glass door & stove top
- High definition effect
- Extra deep 3D coals
- Relaxing smoky flames
- LED brightness control
- Thermostatic remote & manual control operation



Glass 2



GLASS 2
Video



Glass 1

Specification

Dimensions: mm	Glass 1 Glass 2	H 583 x W 430 x D 334 H 591 x W 524 x D 295
Heat Output		1.0kW – 2.0kW
Finish Steel Fabricated Body Glass Door		 Black Glass & Chrome
Model Number	Glass 1 Glass 2	CESSMDRE-ERP CESLMDRE-ERP



GLASS 1
Video

FMK RAPTURE

Flamonik Wall Mounted Fire



Video



Features

- Flat glass fascia
- Distinctive flame effect
- Raised log fuel bed
- Thermostatic remote & manual control operation
- Includes wall fixing bracket



Magenta



Blue



Amber



Specification

Dimensions: mm	H 440 x W 686 x D 110
Heat Output	0.75kW - 1.5kW

Finish

	Black Glass
Model Number	CFECRORE-ERP

FMK ENCHANT

Flamonik Wall Mounted Fire



Video



Features

- Curved glass fascia
- Enchanting smoky flame effect
- Raised log fuel bed
- Thermostatic remote & manual control operation
- Includes wall fixing bracket



Magenta



Blue



Amber



Specification

Dimensions: mm	H 441 x W 916 x D 126
Heat Output	0.75kW - 1.5kW

Finish

	Black Glass
Model Number	CFECEORE-ERP

ACCENT TRADITIONAL

Hearth Inset Fire



Video



Features

- Open fire experience
- Lively ribbon flame effect
- Coal effect fuel bed
- LED brightness control
- Thermostatic remote & manual control operation



Chrome

Finish

- Steel Fabricated
Metallic Plated Trim
- Brass CREC1SRE2
 - Chrome CREC37RE2
- Model Number

Specification

Dimensions: mm	H 595 x W 490 x D 35
Heat Output	1.0kW - 2.0kW

ACCENT INFUSION

Hearth Inset Fire



Video



Features

- Open fire experience
- Lively ribbon flame effect
- Coal effect fuel bed
- LED brightness control
- Thermostatic remote & manual control operation



Brass & Black



Black & Chrome

Finish

- Steel Fabricated Fascia
Dual Metallic & Painted
- Brass & Black CREC10RE2
 - Black & Chrome CREC20RE2
 - Chrome & Satin Silver CREC30RE2
- Model Number

Specification

Dimensions: mm	H 595 x W 498 x D 83
Heat Output	1.0kW - 2.0kW

Freestanding Suites 8-19

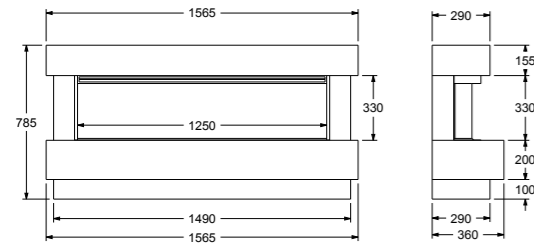

QUANTUM s1250

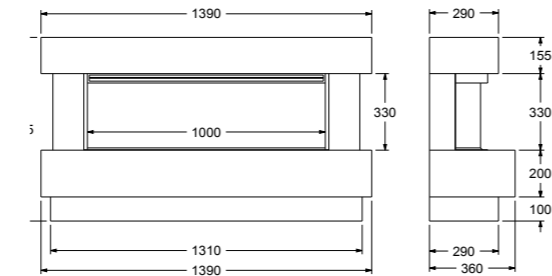

QUANTUM s1000

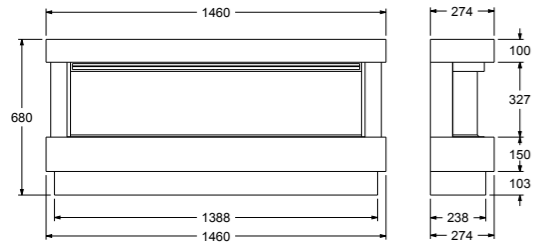

E-VR CASINO s1250

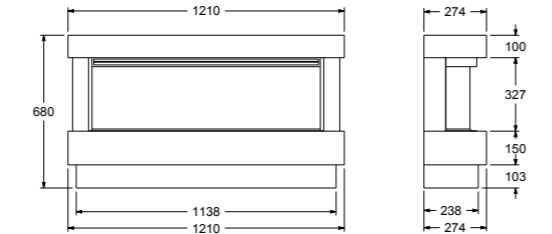

E-VR CASINO s1000

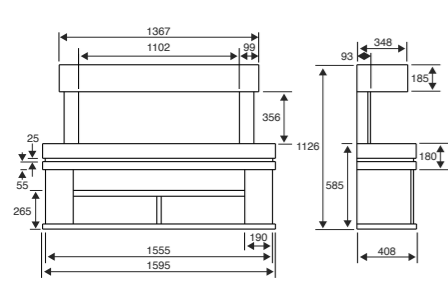

MEDIA 1100 ILLUMIA

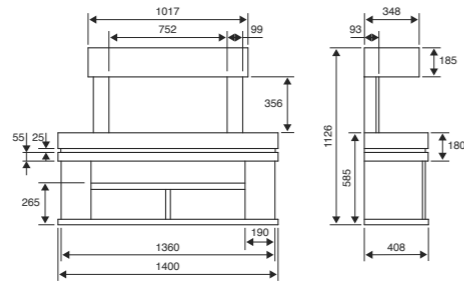

MEDIA 750 ILLUMIA

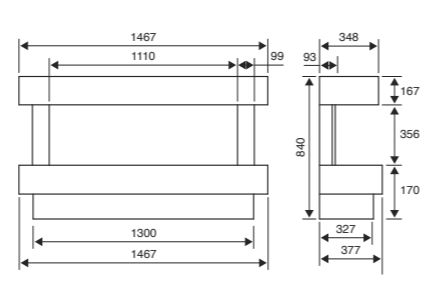

CARINO 1100 ILLUMIA

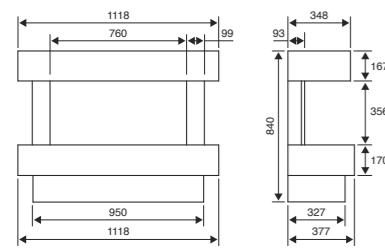

CARINO 750 ILLUMIA

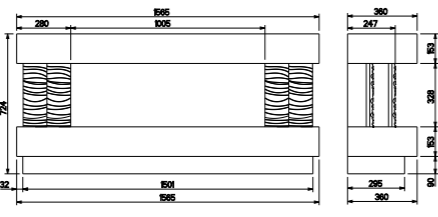

GEMMA 1000 ILLUMIA

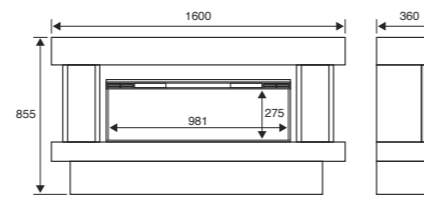

ORBITAL 1000 ILLUMIA

Built-In 3 Sided Glass Fires 20-30

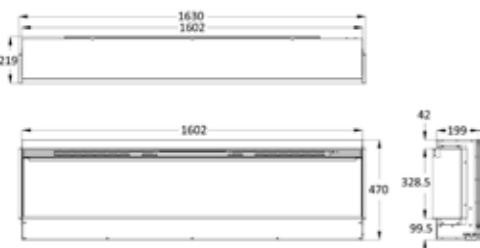

COMMODUS s1600



COMMODUS s1250

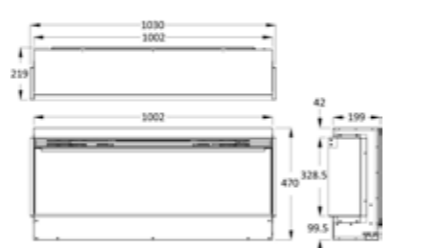

COMMODUS s1000

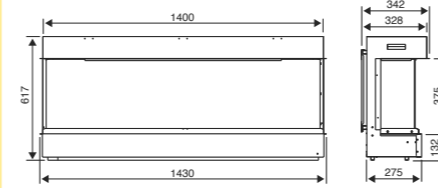

1400

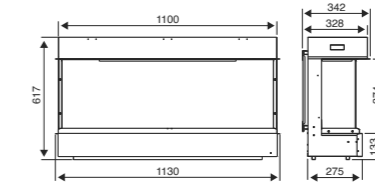

1100

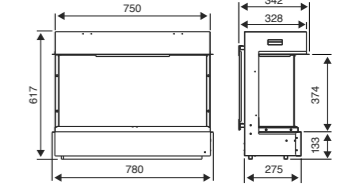

750

Wall Mounted 3 Sided Suites 31-33

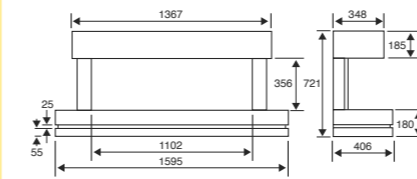

VOLARE 1100 ILLUMIA

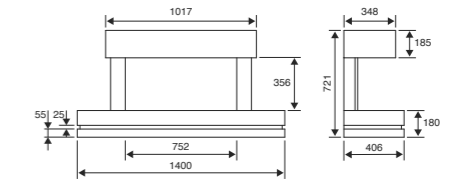

VOLARE 750 ILLUMIA

Wall Inset Fires 30-35

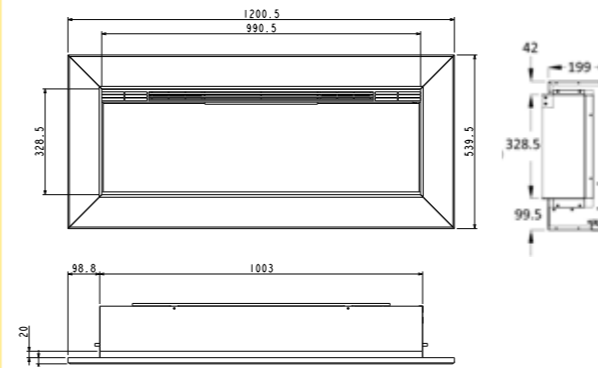

COMMODUS s1000 + FASCIA

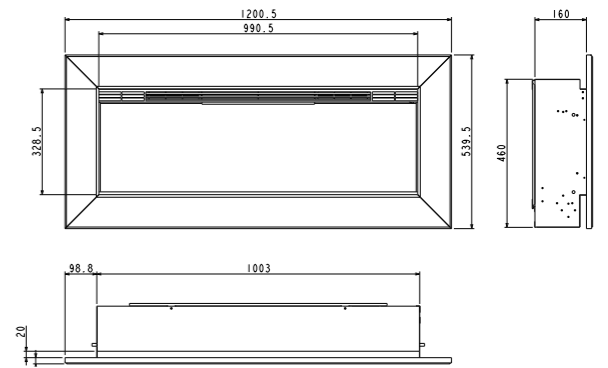

COMMODUS + FASCIA

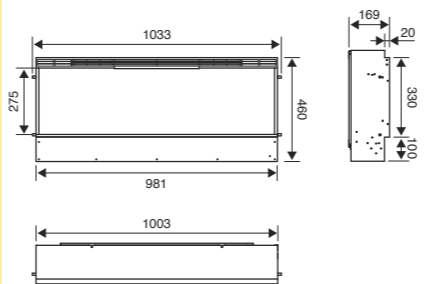

COMMODUS

Wall Mounted Fires 36-37

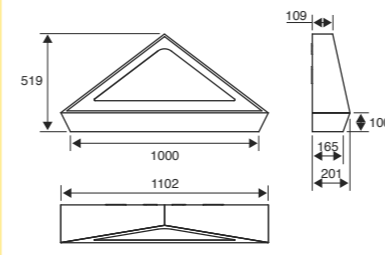

LOUVRE

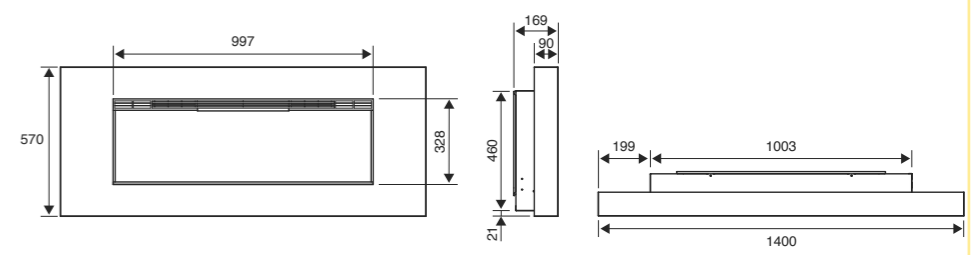

BASILICA

Hearth Inset Fires 38-41

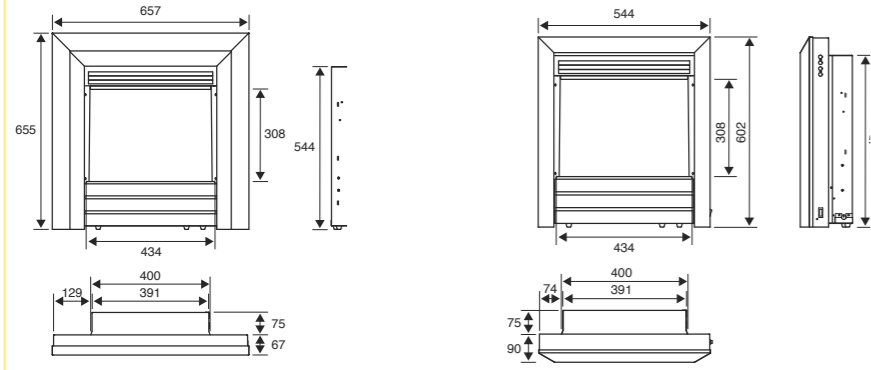

ACERO

PARRILLA

ELECTRISTOVE® H3D/VR

Stoves 42-51

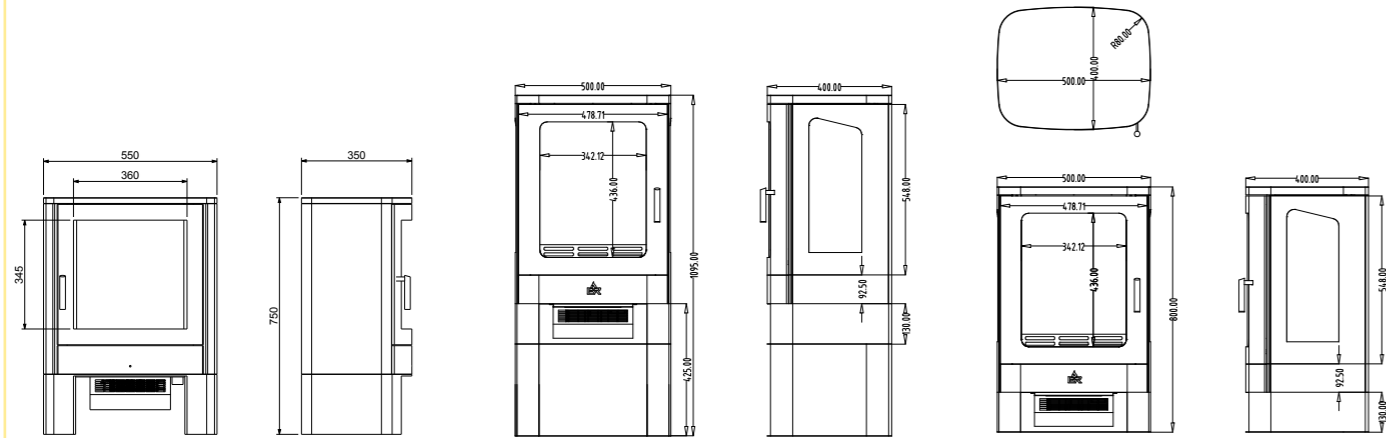

HOLOGRAM GENESIS

SPECTRE LS

SPECTRE

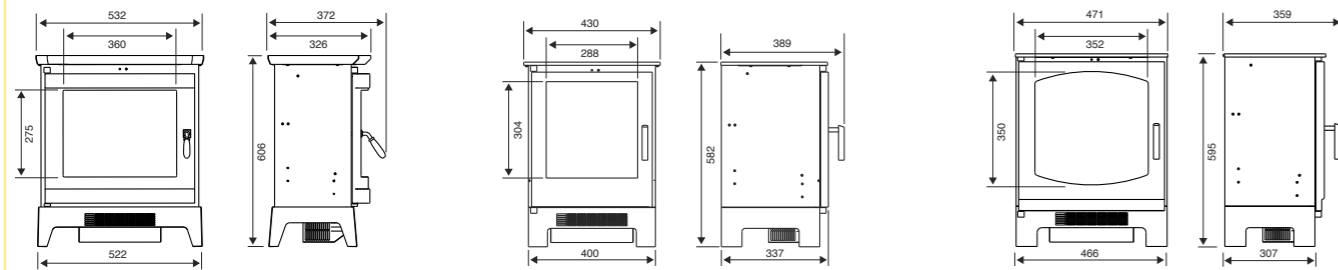

ROCHESTER

ARUNDEL

LUXIMA

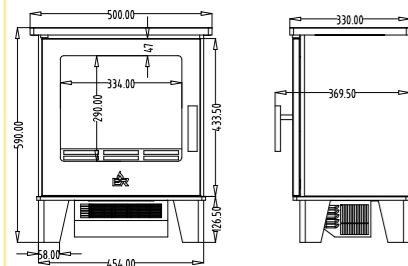

STRATFORD

Firebeam Suites 54-61

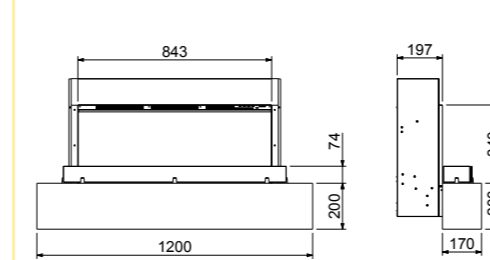

FIREBEAM 800 ILLUMIA

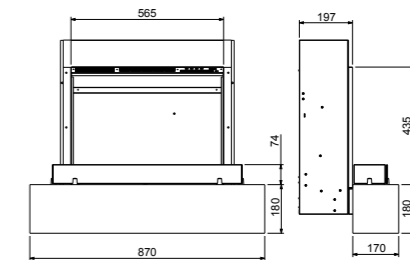

FIREBEAM 600 ILLUMIA

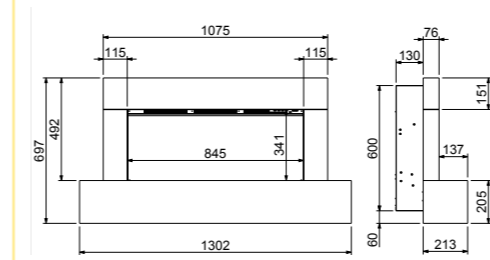

FIREBEAM XL800 ILLUMIA

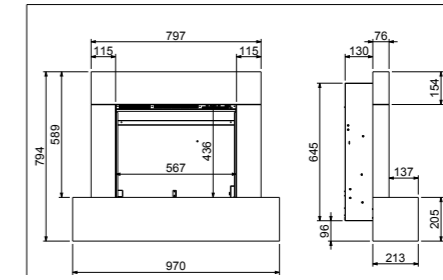

FIREBEAM XL600 ILLUMIA

Freestanding Suites 62-79

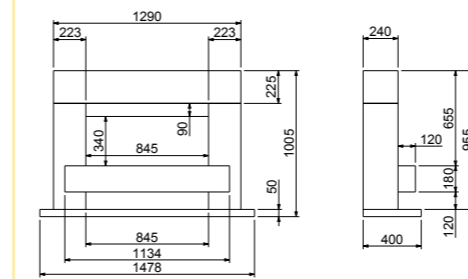

LUMINAIRE 800 ILLUMIA

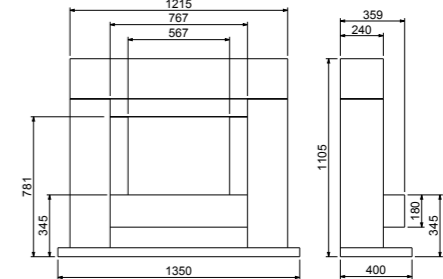

LUMINAIRE 600 ILLUMIA

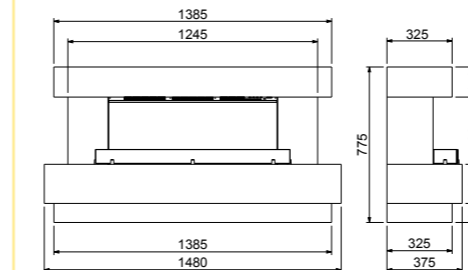

SKYFALL 800 ILLUMIA

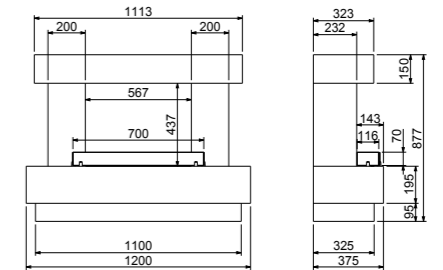

SKYFALL 600 ILLUMIA

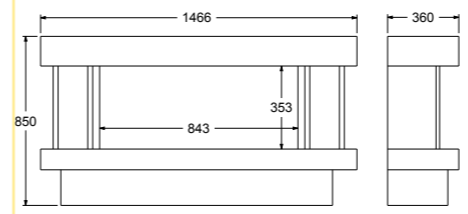

ORBITAL 800 ILLUMIA

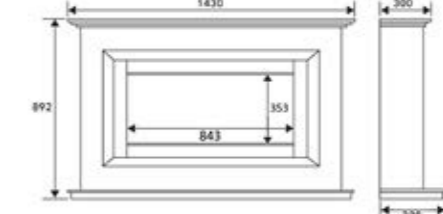

VEGA

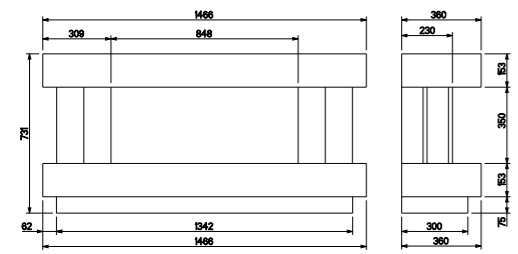

GEMMA 800 ILLUMIA

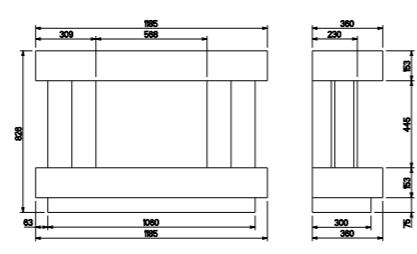

GEMMA 600 ILLUMIA

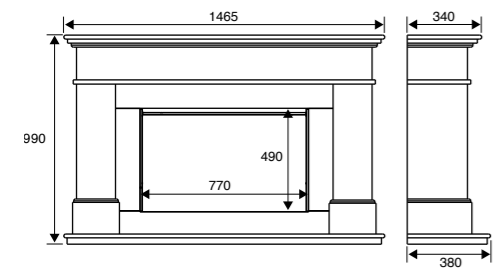

ADOUR ALEESIA ILLUMIA

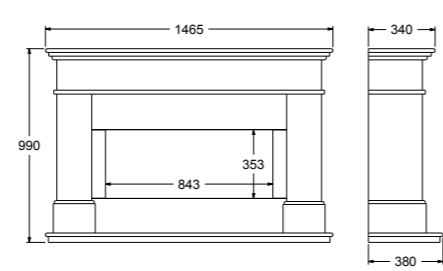

ADOUR ELITE ILLUMIA

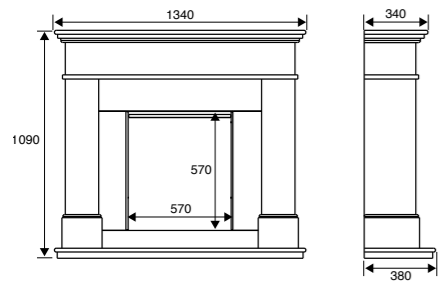

ADOUR ASENCIO ILLUMIA

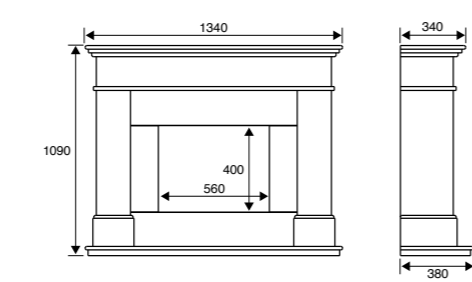

ADOUR ILLUMIA

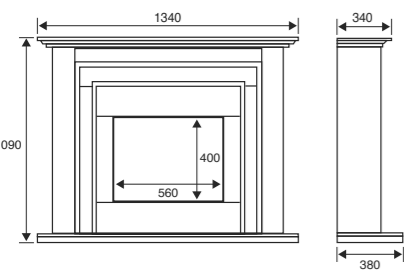

CANELO ILLUMIA

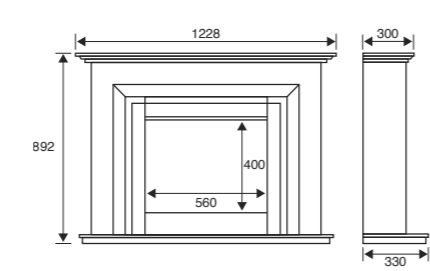

ELARA

Inset Limestone Suites 80-86



PARADA ELITE ILLUMIA

AVIGNON ELITE

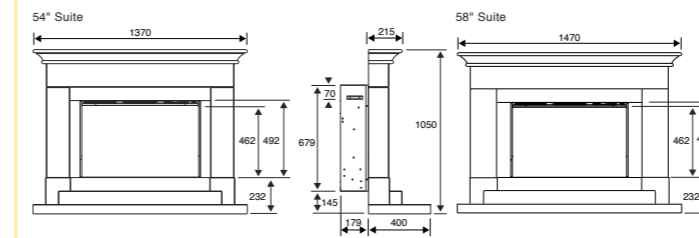

ALEESIA ILLUMIA

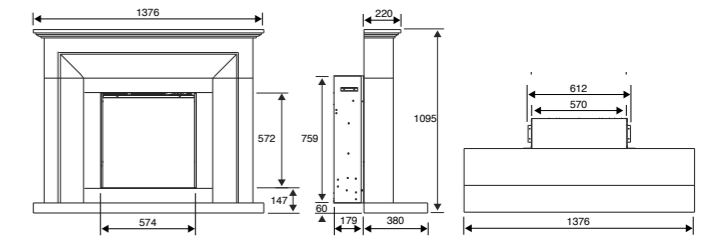

ASENCIO

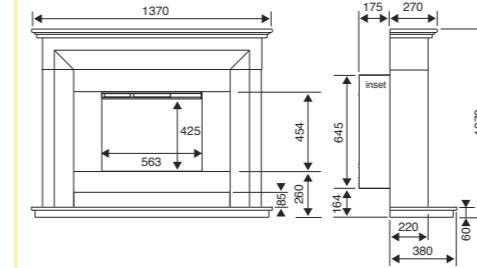

ANGELO

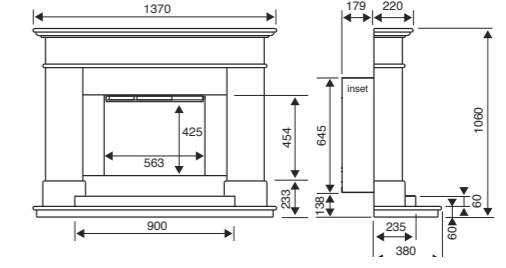

BOTICELLI

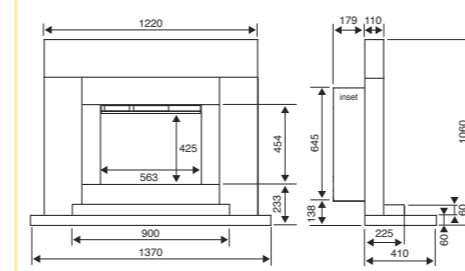

PABLO

Wall Inset Fires 87-95

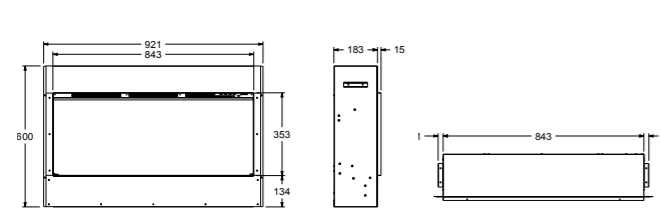

ELITE

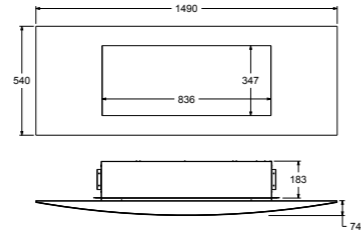

VICHY

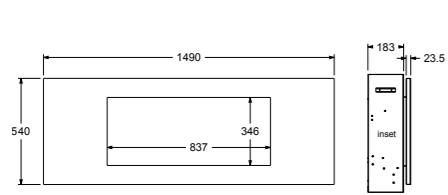

METZ

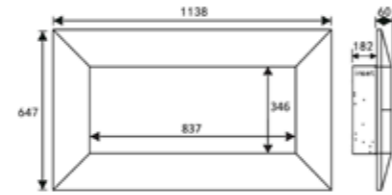

INSTINCT

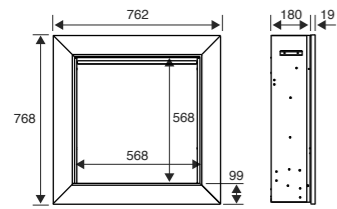

EVORA ASENCIO

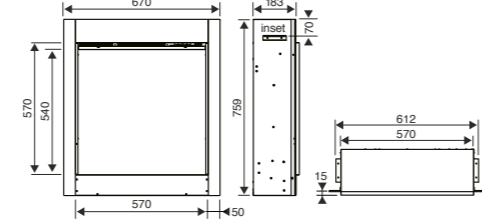

ASENCIO

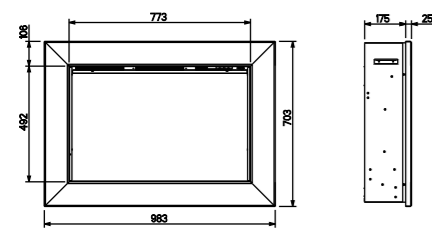

VADER ALEESIA

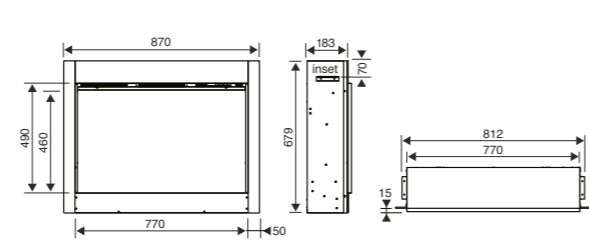

ALEESIA

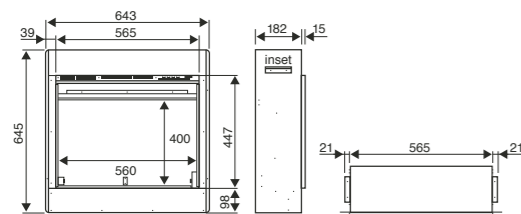

CELENA

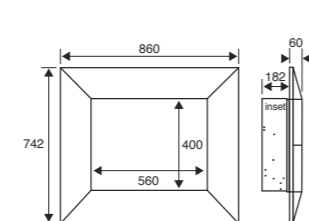

IMPULSE

Hearth Inset Fires 96-103

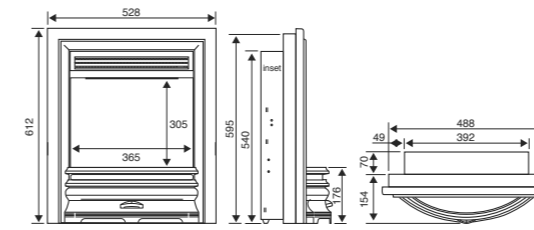

ARCADIA

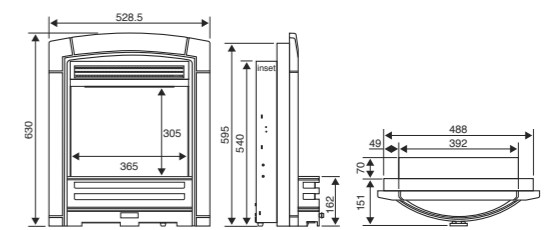

DECADENCE

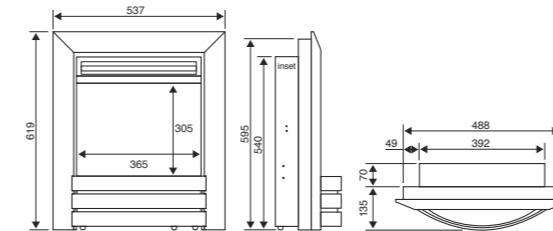

CAMBER

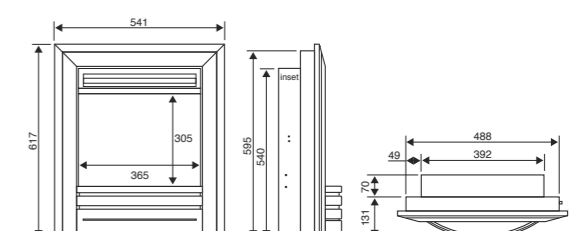

FRONTIER

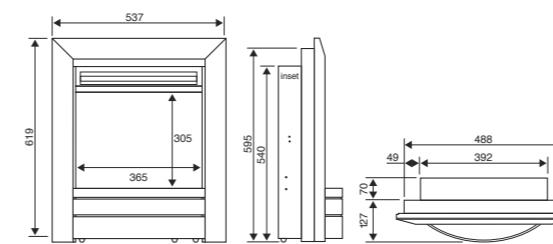

ESSENCE

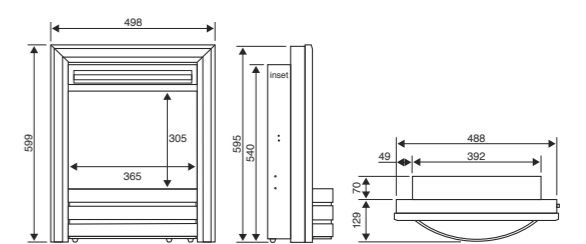

DESIGNER

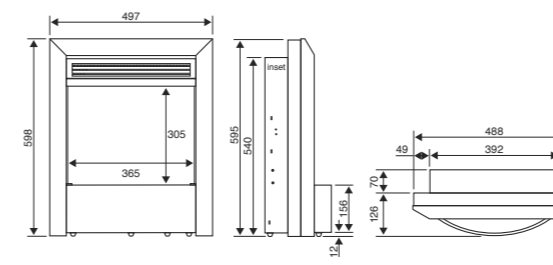

ENDURA

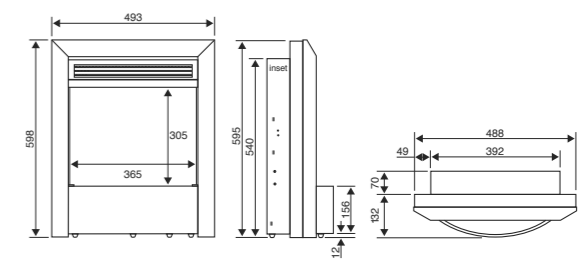

CONTEMPORARY

Wall Mounted Fires 104-109

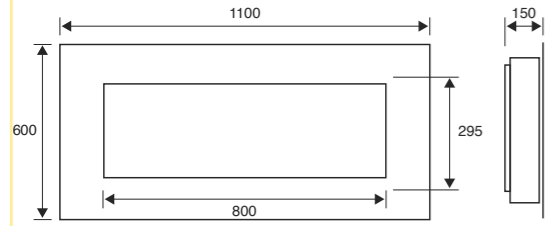

PRESTIGE

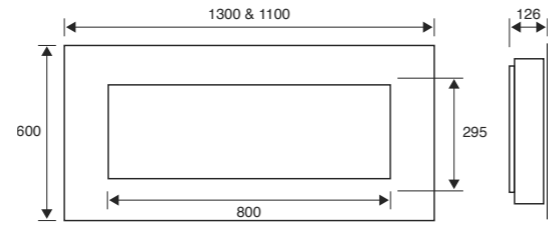

BLACK GLASS

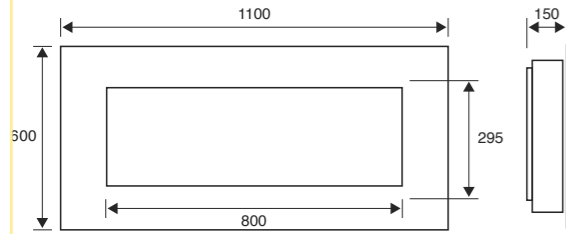

ROYAL BOTTICINO

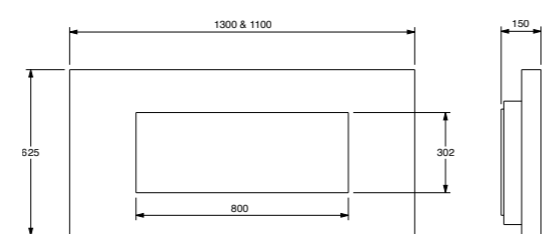

TRAVERTINE

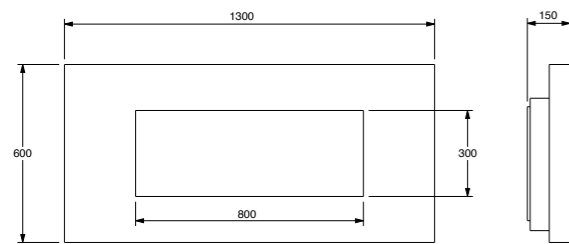

PIANO BLACK

Hearth Inset Fires 110-117

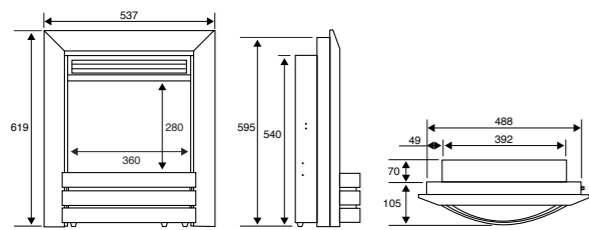

CAMBER

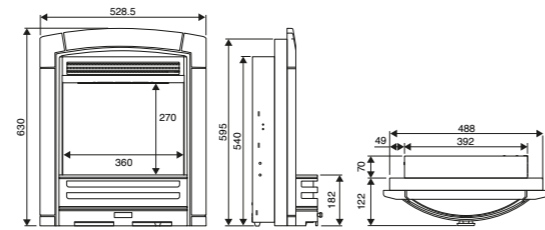

DECADENCE

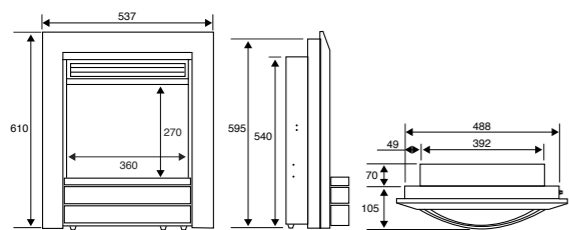

ESSENCE

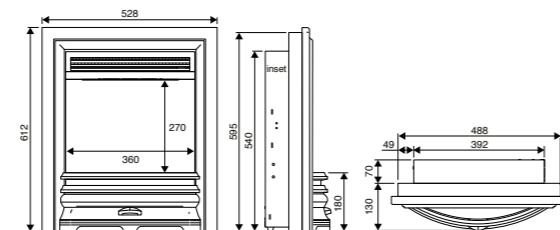

ARCADIA

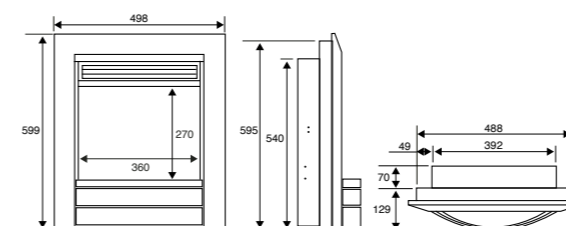

SIGNATURE

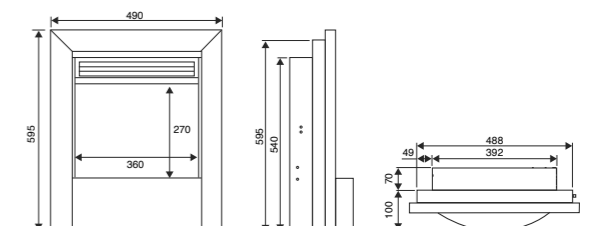

DAISY

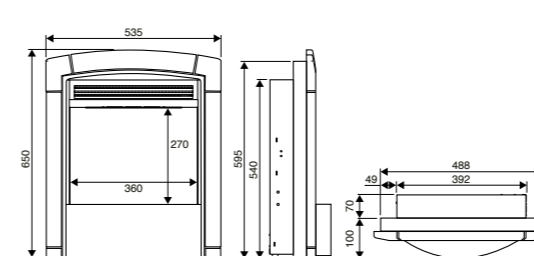

CARESS

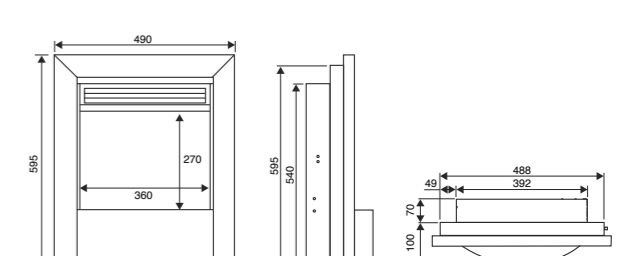

BAUHAUS

ELECTRISTOVE® XD Stoves 118-121

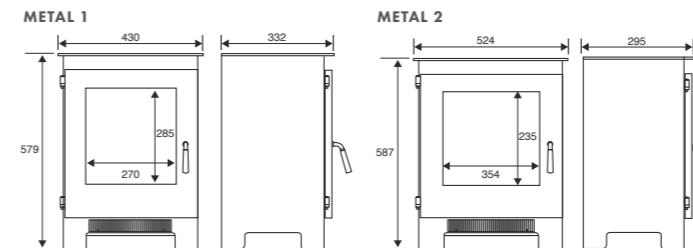

ELECTRISTOVE METAL

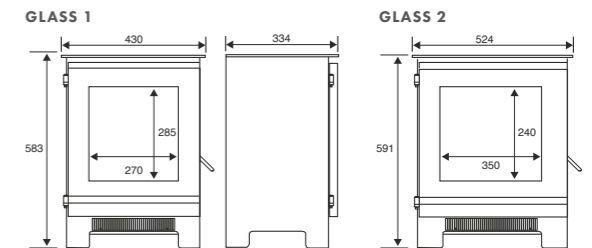

ELECTRISTOVE GLASS

FLAMONIK Wall Outset 122-123

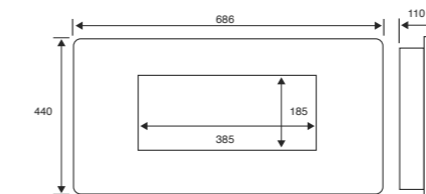

RAPTURE

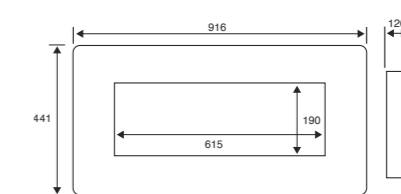

ENCHANT

ACCENT Hearth Inset 124-125

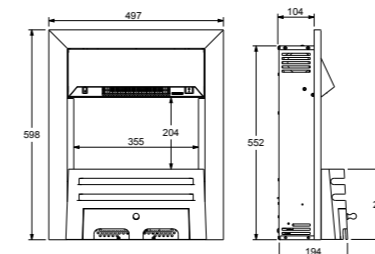

ACCENT TRADITIONAL

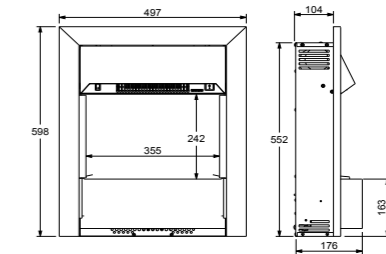

ACCENT INFUSION



DISCLAIMER

Our policy is one of constant development and improvement. We therefore reserve the right to revise designs and specifications of our products without formal notice, patents pending. We always recommend our products be viewed in an approved showroom before purchase. Whilst we have taken every care in the preparation of this brochure it is not intended to replace the installation manual which provides more detailed information.

Photography is for illustration purposes only and although every effort has been made to ensure accurate reproduction of typical installations and flame pictures they may vary according to fire model and flue types.

We accept no liability for any loss or damage arising directly or indirectly from the use of this brochure.

We recommend that all our fires are used in conjunction with central heating and not as a primary source of heat.

In the interests of personal safety a suitable fireguard is recommended when children, the elderly and the infirm are present.

This brochure is copyright 2023 and must not be reproduced in whole or in any part without prior written permission.



BFM Europe Ltd, Gordon Banks Drive,
Trentham Lakes, Stoke-on-Trent ST4 4TJ

Tel: 01782 339000

Email: sales@bfm-europe.com

www.celsielectricfires.co.uk

Go direct to the Celsi website on your smart phone or tablet device and use the app to scan the black and white QR codes shown on each page. Alternatively, go to www.celsielectricfires.co.uk to browse all Celsi electric fires.

